



US00D410200S

United States Patent [19] Bulgari

[11] **Patent Number: Des. 410,200**

[45] **Date of Patent: ** May 25, 1999**

[54] **WATCH**

[75] **Inventor: Giovanni Bulgari, London, United Kingdom**

[73] **Assignee: Gianni Bulgari S.p.A., Rome, Italy**

[**] **Term: 14 Years**

[21] **Appl. No.: 29/094,402**

[22] **Filed: Oct. 1, 1998**

[30] Foreign Application Priority Data

Apr. 21, 1998 [XH] Hague Agreement DMA/004075

[51] **LOC (6) Cl. 10-02**

[52] **U.S. Cl. D10/39; D10/30**

[58] **Field of Search D10/1-40, 122-132; 368/280-282, 276-277, 285**

[56] References Cited

U.S. PATENT DOCUMENTS

D. 348,897 7/1994 Dumas D10/39

D. 356,041	3/1995	Bulgari	D10/39
D. 356,268	3/1995	Bulgari	D10/39
D. 366,216	1/1996	Bulgari	D10/39
D. 367,429	2/1996	Bulgari	D10/39
D. 397,944	9/1998	Bulgari	D10/39

Primary Examiner—Nelson C. Holtje
Attorney, Agent, or Firm—Sughrue, Mion, Zinn, Macpeak & Seas, PLLC

[57] CLAIM

The ornamental design for a watch, as shown.

DESCRIPTION

FIG. 1 is a perspective view of a watch showing my new design;
FIG. 2 is a top plan view thereof;
FIG. 3 is a bottom plan view thereof;
FIG. 4 is a side elevational view of one side thereof;
FIG. 5 is a side elevational view of an opposite side thereof;
FIG. 6 is an end elevational view of one end thereof; and,
FIG. 7 is an end elevational view of an opposite end thereof.

1 Claim, 2 Drawing Sheets

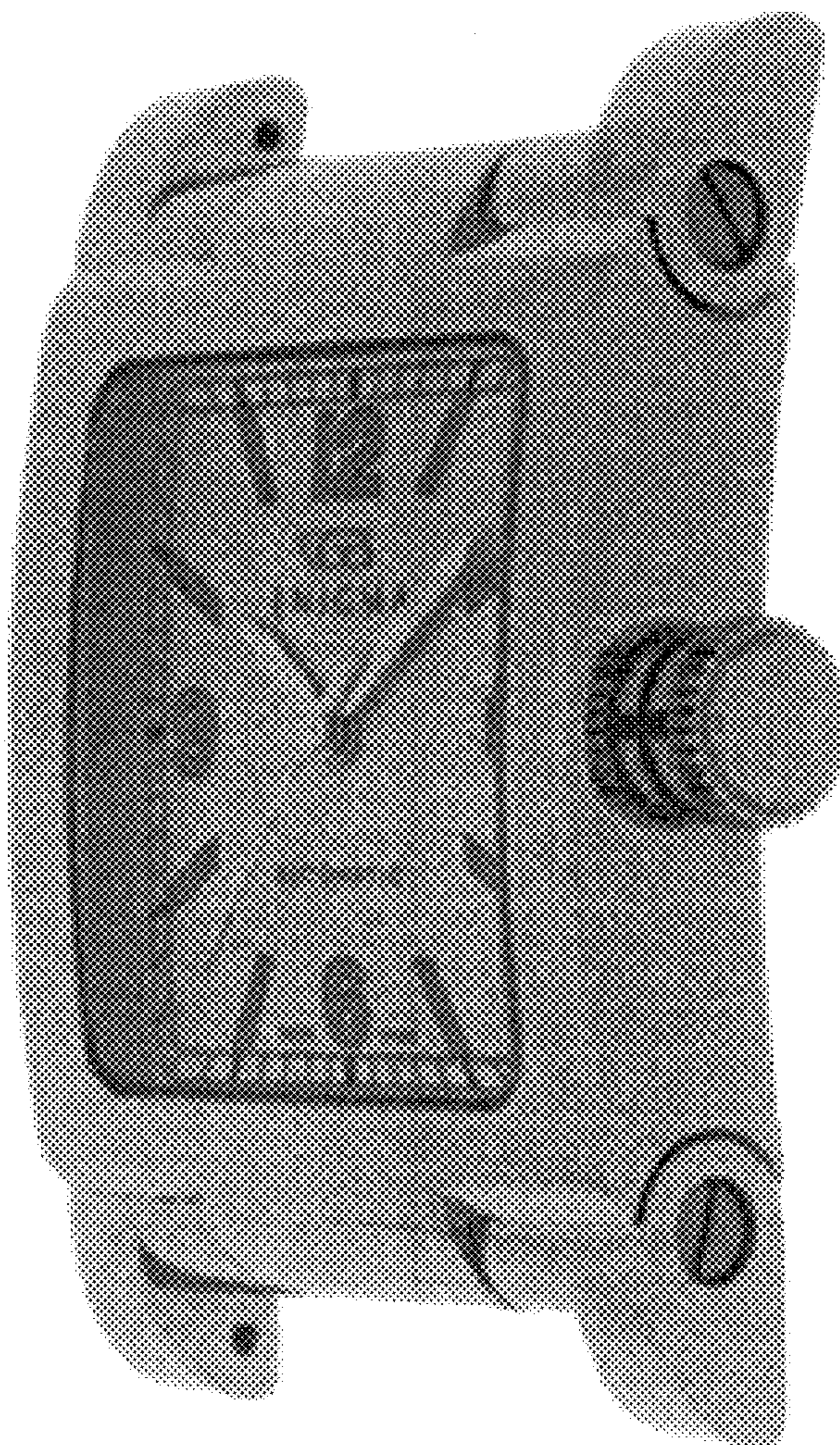

FIG. 1

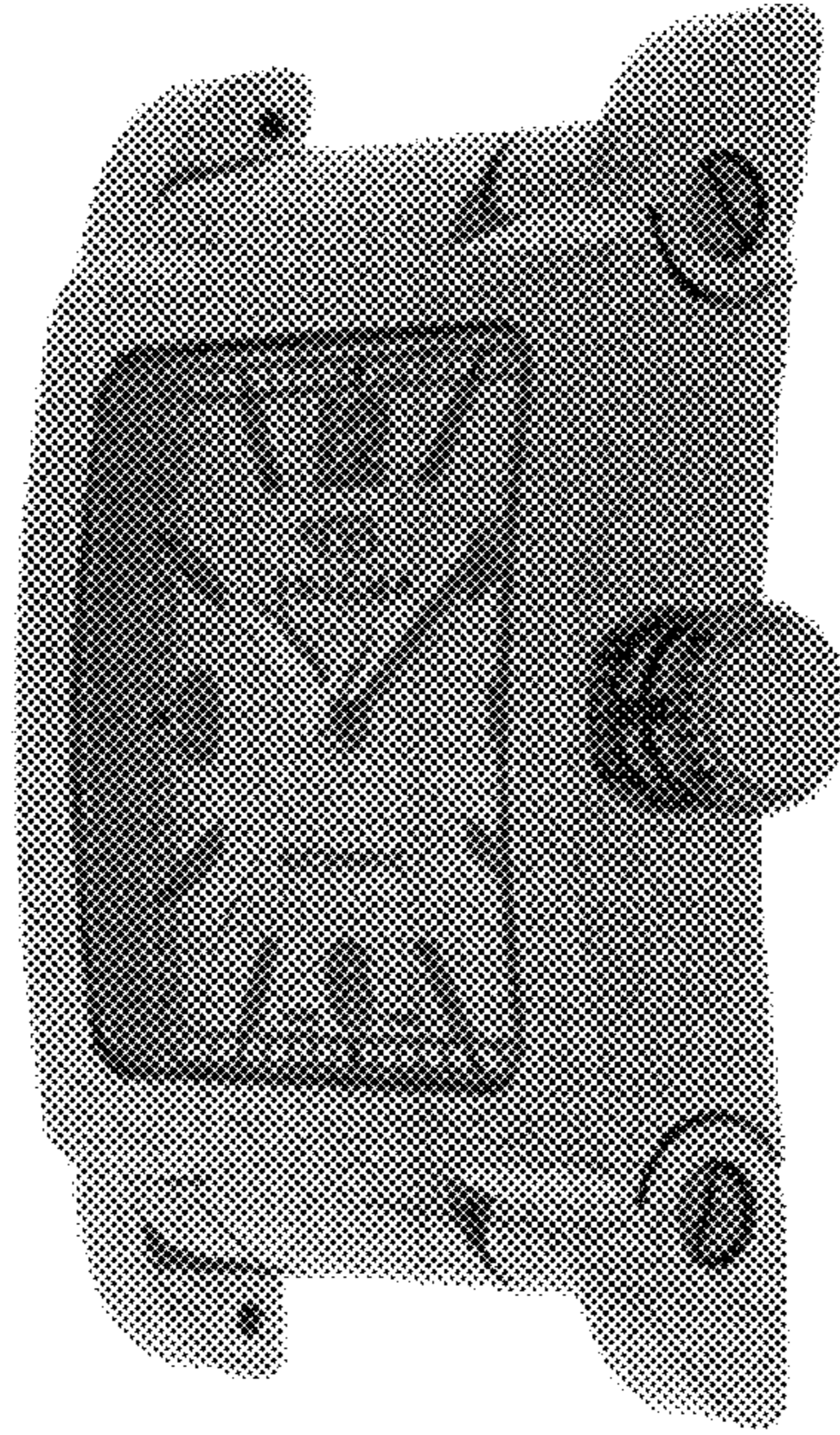

FIG. 2

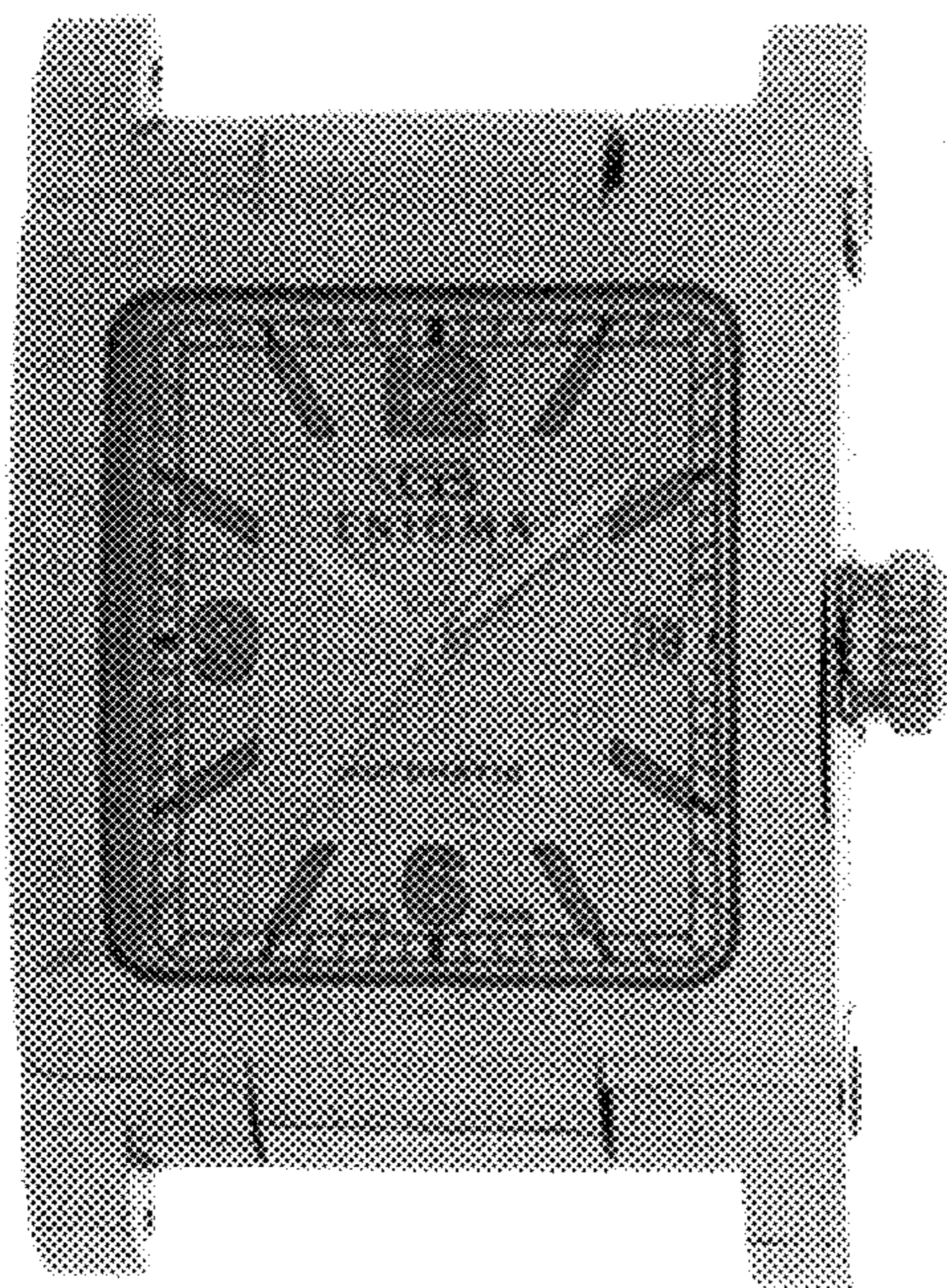

FIG. 3

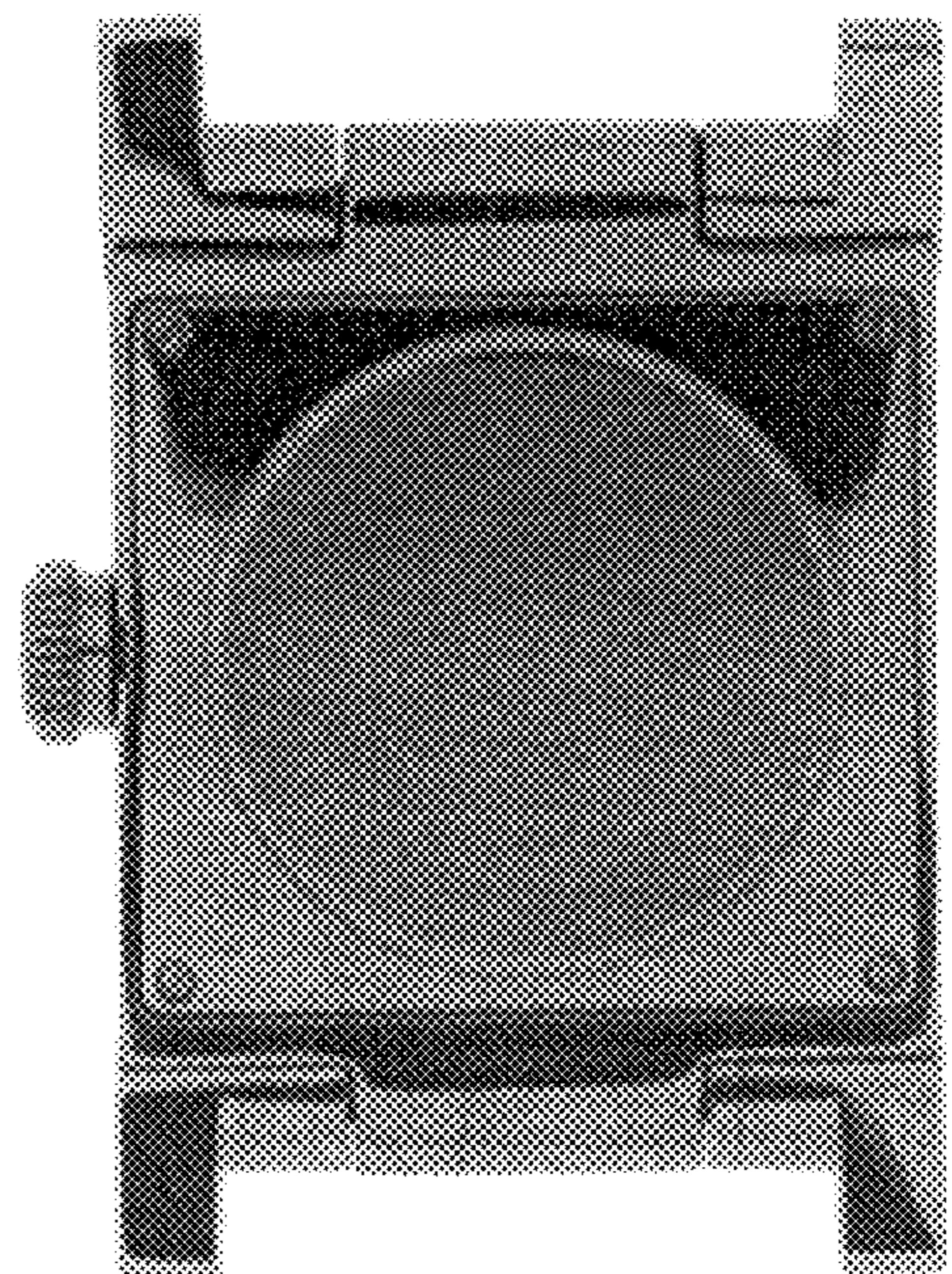

FIG. 4

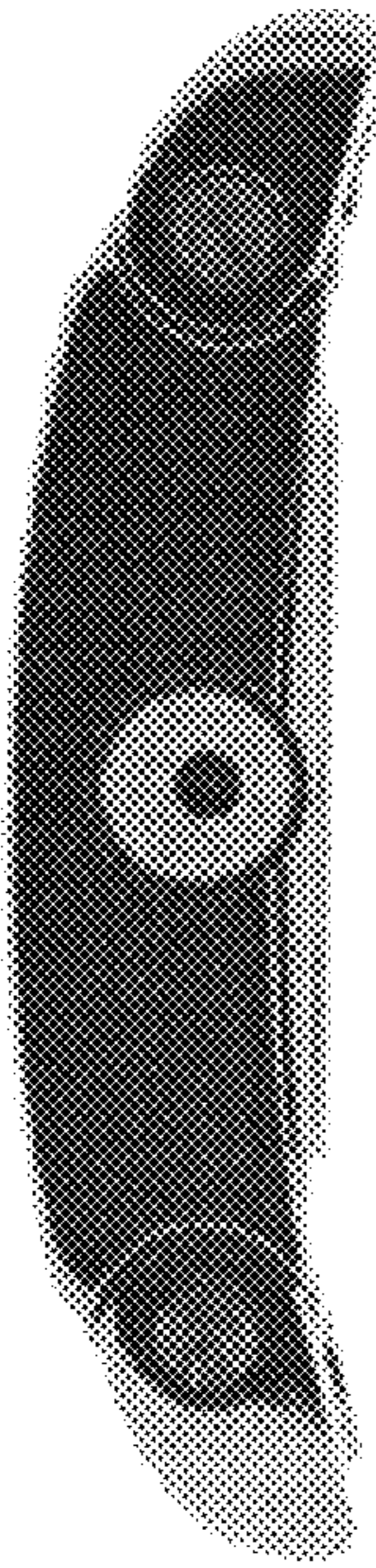

FIG. 5

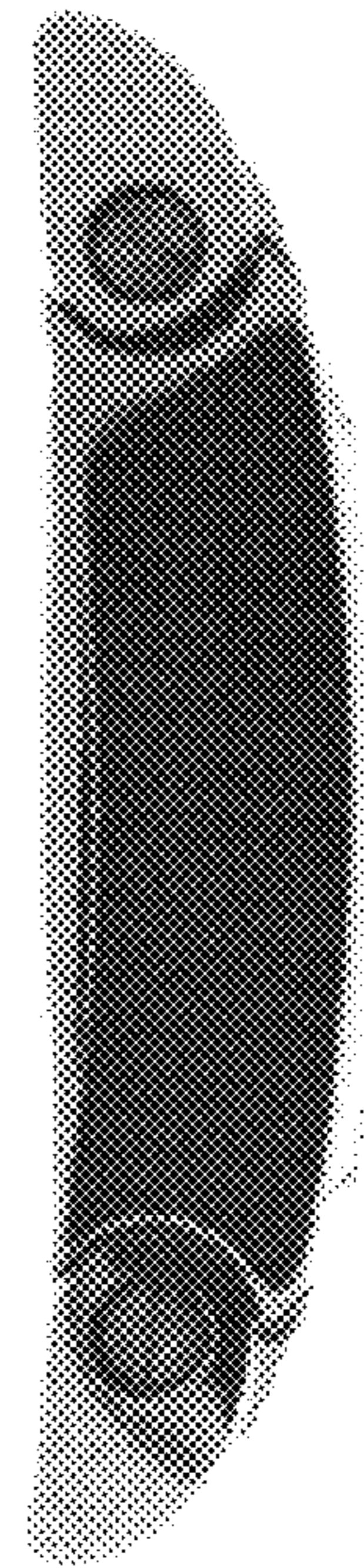

FIG. 6

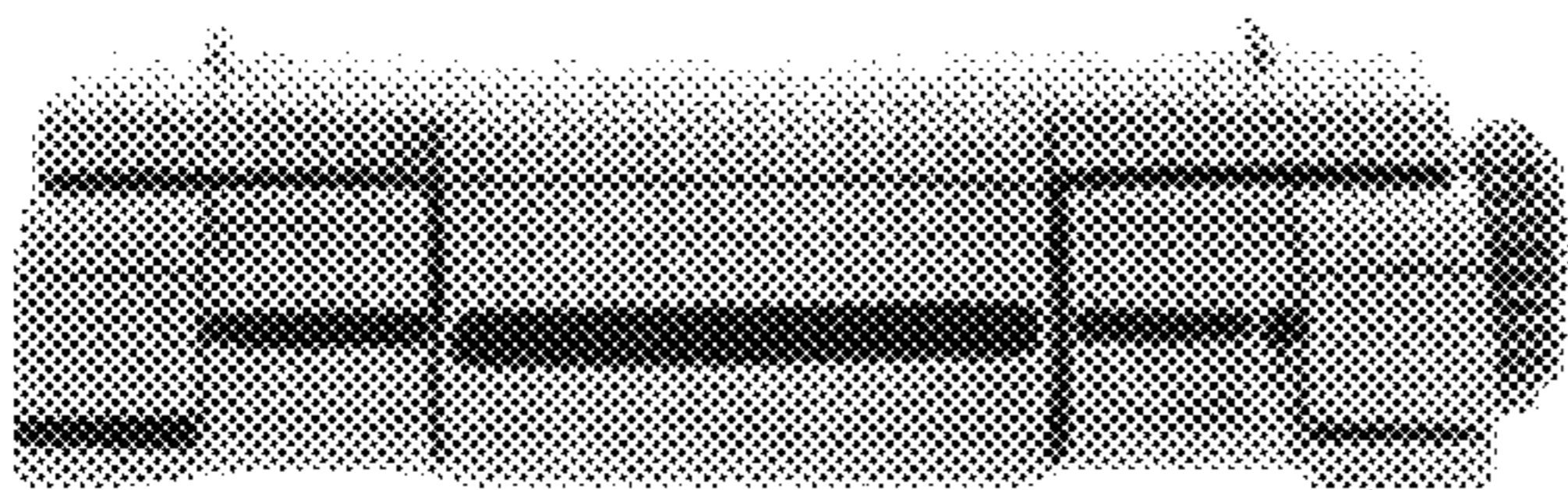

FIG. 7

