



US00D410178S

United States Patent [19] Clayson

[11] **Patent Number: Des. 410,178**

[45] **Date of Patent: ** May 25, 1999**

[54] **HINGE PIN EXTRACTOR**

[75] Inventor: **Stephen Clayson**, 104 Bassett Blvd.,
Whitby, Ontario, Canada, L1N 8X3

[73] Assignees: **Stephen Clayson; Diana Clayson**, both
of Whitby, Canada

[**] Term: **14 Years**

[21] Appl. No.: **29/082,567**

[22] Filed: **Jan. 26, 1998**

[51] **LOC (6) Cl.** **08-05**

[52] **U.S. Cl.** **D8/16; D8/89**

[58] **Field of Search** D8/89, 88, 15-20;
7/138, 170, 128, 166, 167; 81/177.4, 177.6,
125; 254/25; 29/244-281

[56] **References Cited**

U.S. PATENT DOCUMENTS

D. 197,205	12/1963	Estwig	D8/89
D. 270,944	10/1983	Hostetler	D8/16 X
D. 287,927	1/1987	Zankich	D8/17
D. 350,270	9/1994	Jensen	D8/89
D. 353,755	12/1994	Lane	D8/17
664,494	12/1900	Olsen	254/25
743,183	11/1903	Miller	254/25
1,641,252	9/1927	Dickey	81/125
3,689,977	9/1972	Crabbe	29/253

4,464,819	8/1984	Steck et al.	29/267
4,627,141	12/1986	Teske	29/275
5,054,180	10/1991	Combs	29/275
5,099,562	3/1992	Laughran	29/275
5,435,030	7/1995	Phillips	7/138
5,438,743	8/1995	Simington et al.	29/275

Primary Examiner—Jeffrey Asch
Attorney, Agent, or Firm—Schmeiser, Olsen & Watts

[57] **CLAIM**

The ornamental design for a hinge pin extractor, as shown.

DESCRIPTION

FIG. 1 is a perspective view of a first embodiment of the hinge pin extractor;
 FIG. 2 is a rear view of the embodiment of FIG. 1;
 FIG. 3 is a front view of the embodiment of FIG. 1;
 FIG. 4 is a side view of the embodiment of FIG. 1;
 FIG. 5 is a plan view of the embodiment of FIG. 1;
 FIG. 6 is a bottom view of the embodiment of FIG. 1;
 FIG. 7 is a perspective view of a second embodiment of the hinge pin extractor;
 FIG. 8 is a rear view of the embodiment of FIG. 7;
 FIG. 9 is a front view of the embodiment of FIG. 7;
 FIG. 10 is a side view of the embodiment of FIG. 7;
 FIG. 11 is a plan view of the embodiment of FIG. 7; and,
 FIG. 12 is a bottom view of the embodiment of FIG. 7.

1 Claim, 4 Drawing Sheets

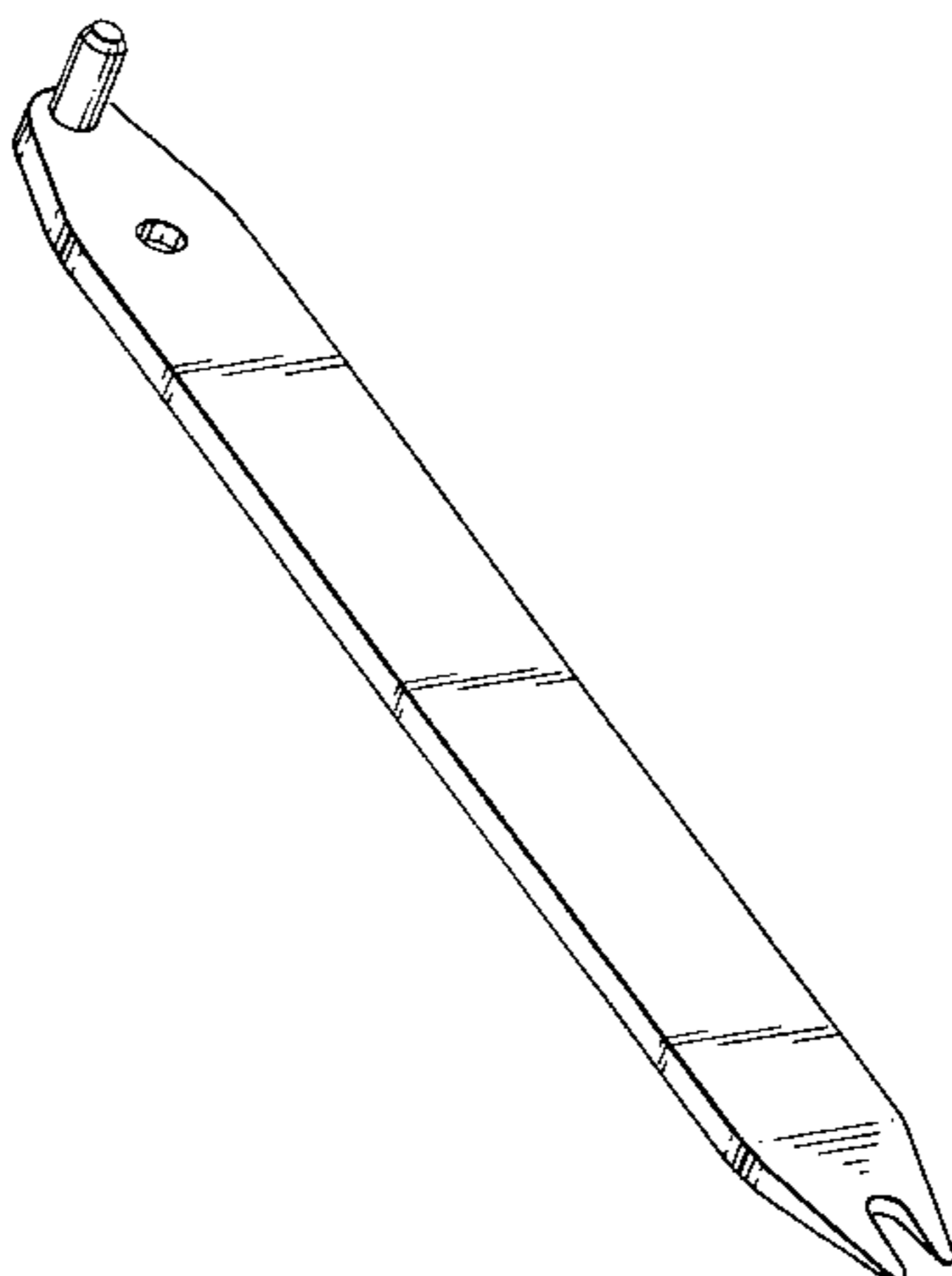
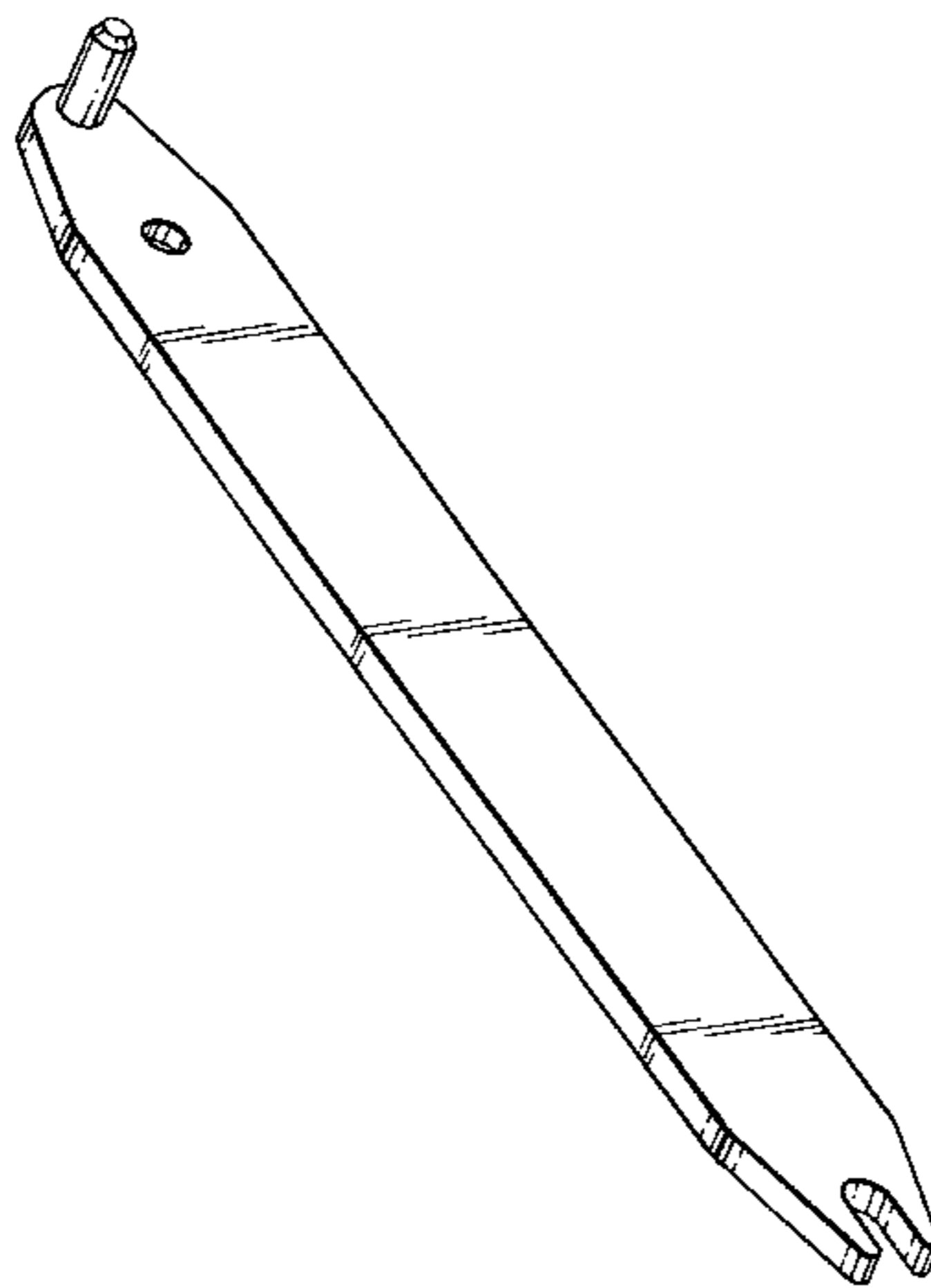

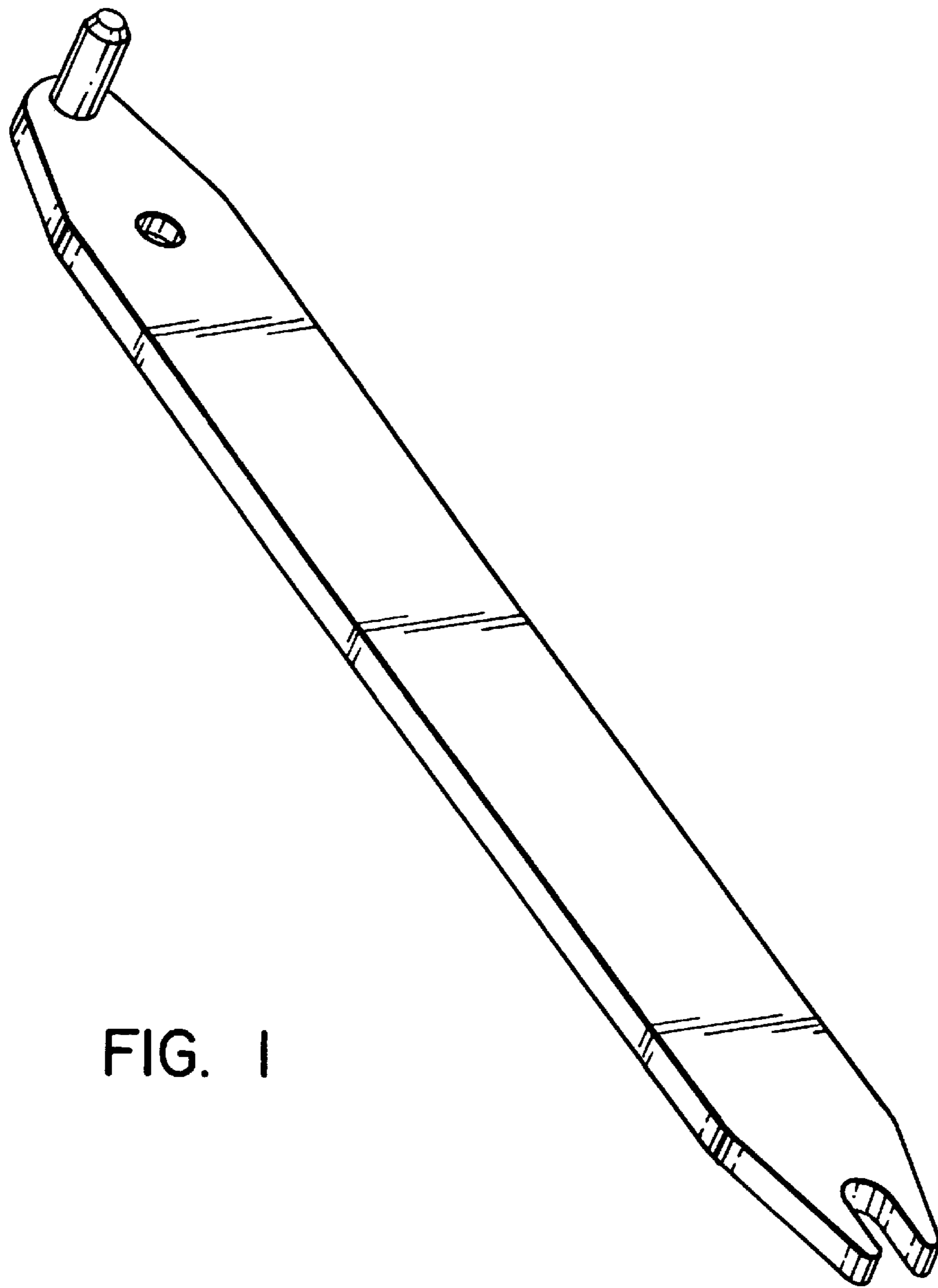

FIG. 1

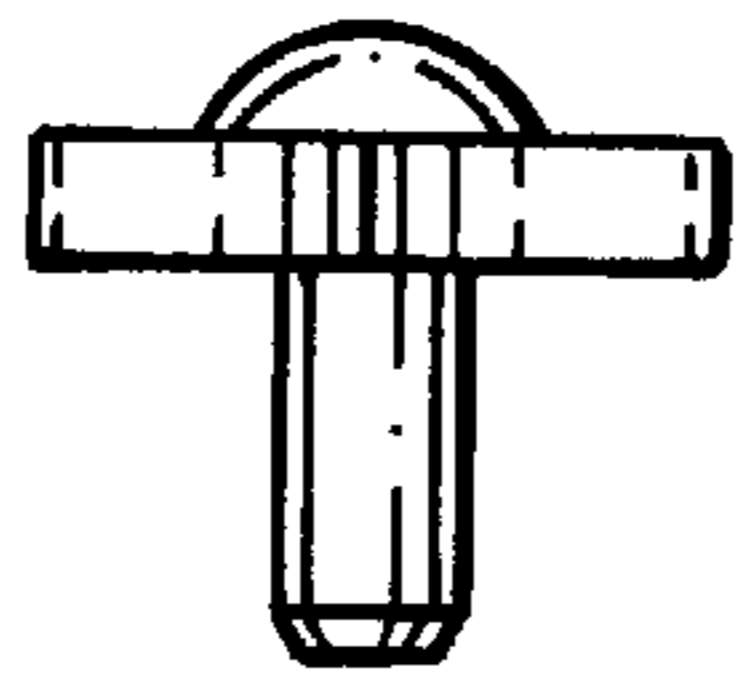

FIG. 2

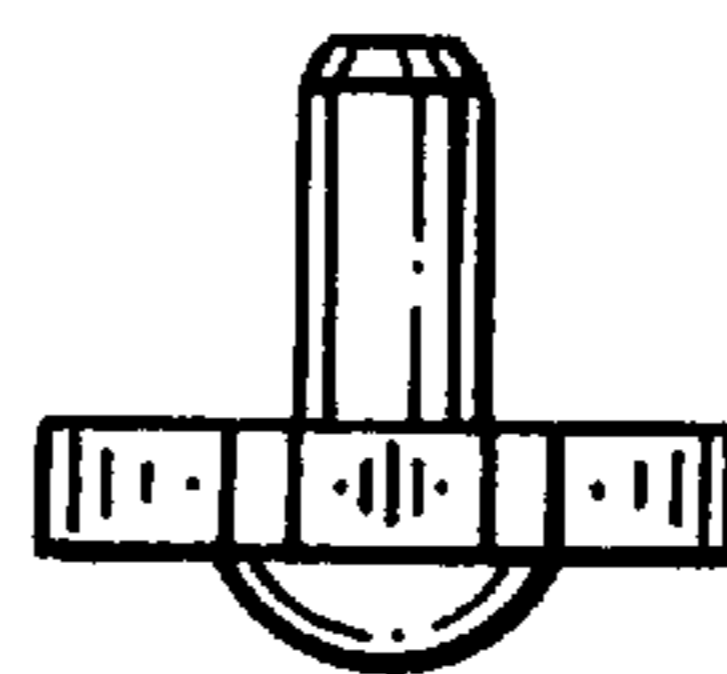

FIG. 3

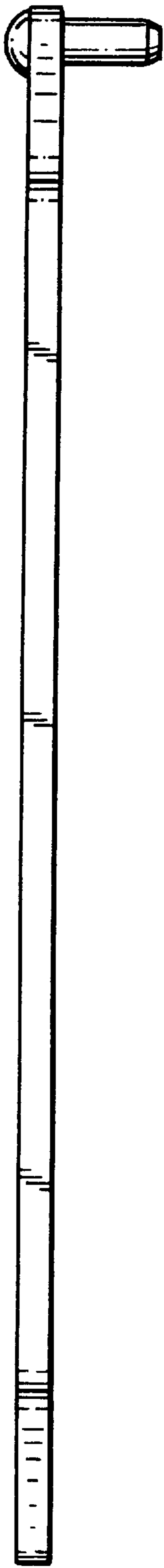

FIG. 4

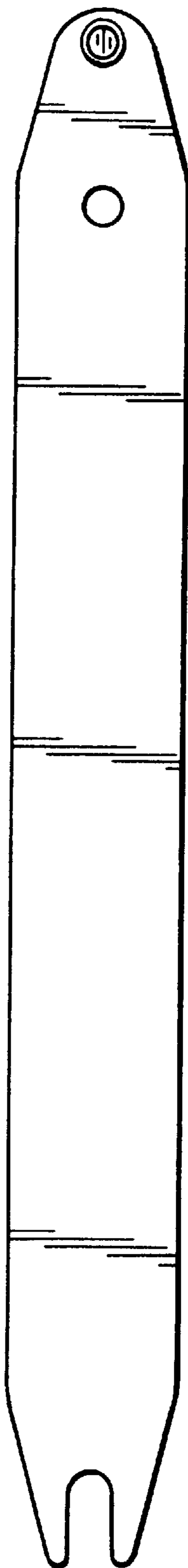

FIG. 5

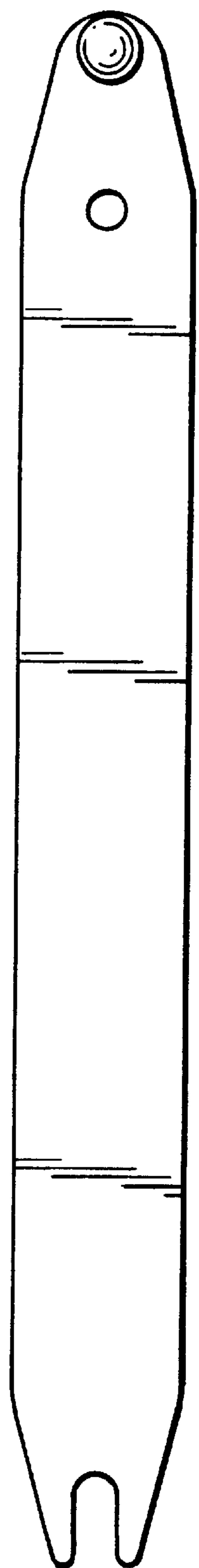

FIG. 6

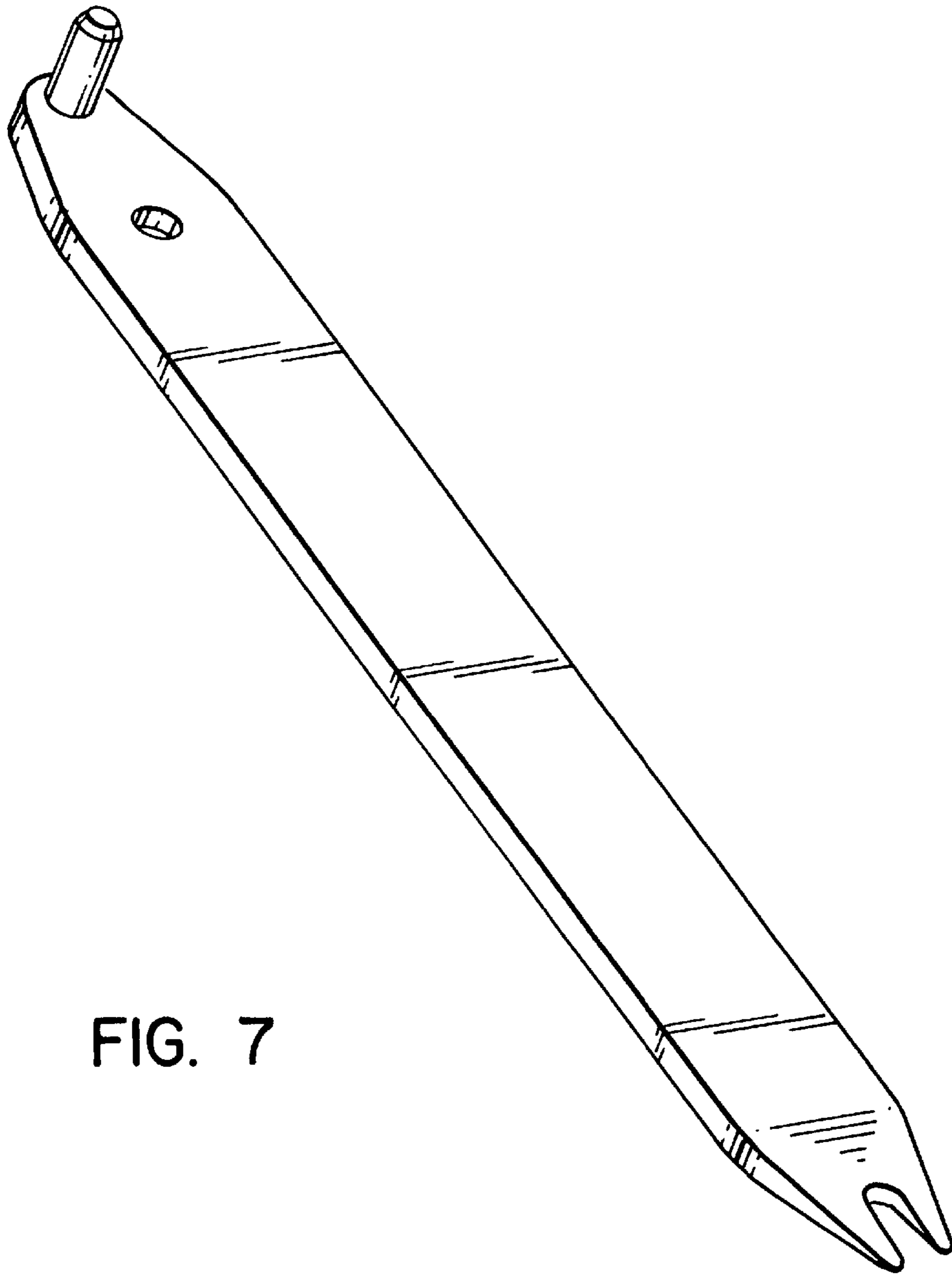

FIG. 7

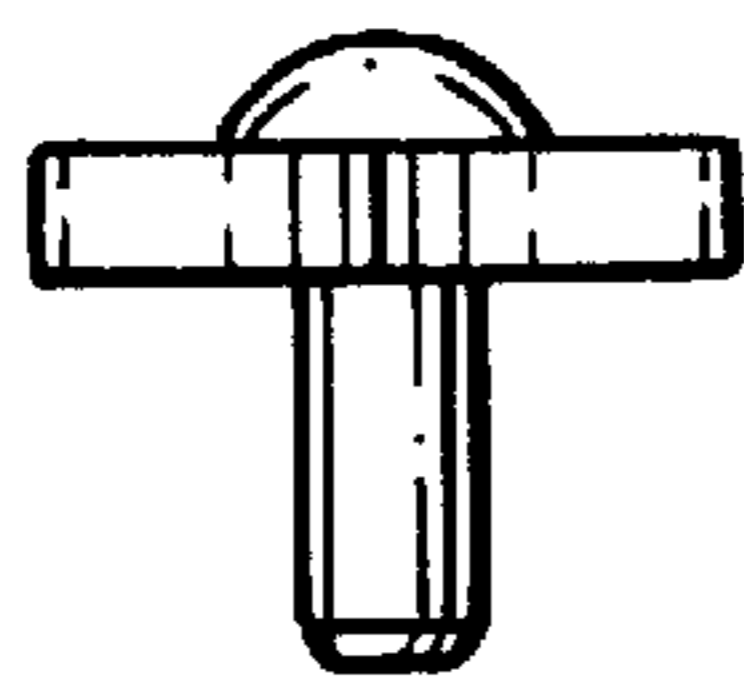

FIG. 8

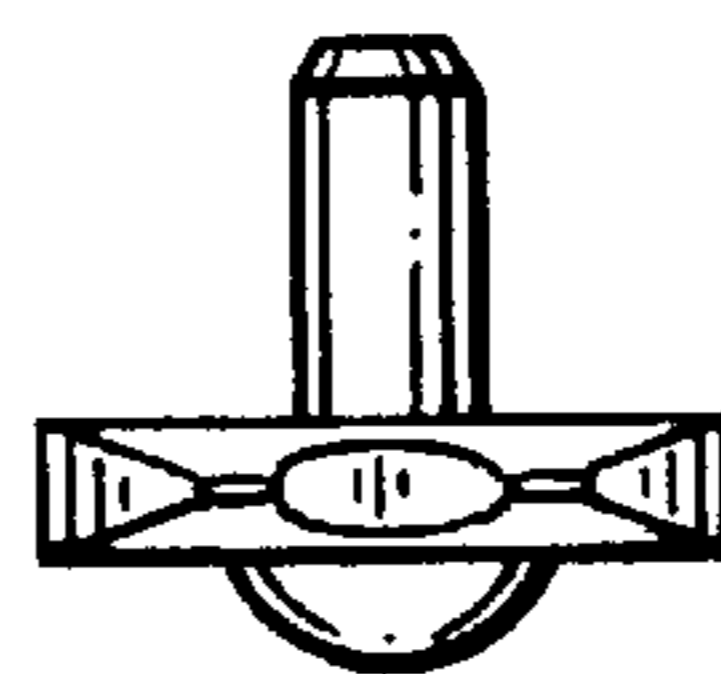

FIG. 9

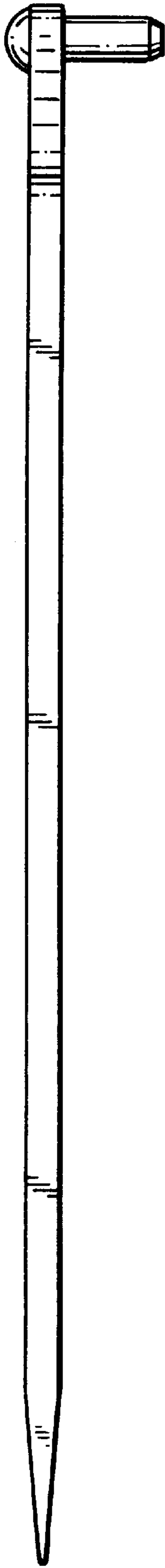

FIG. 10

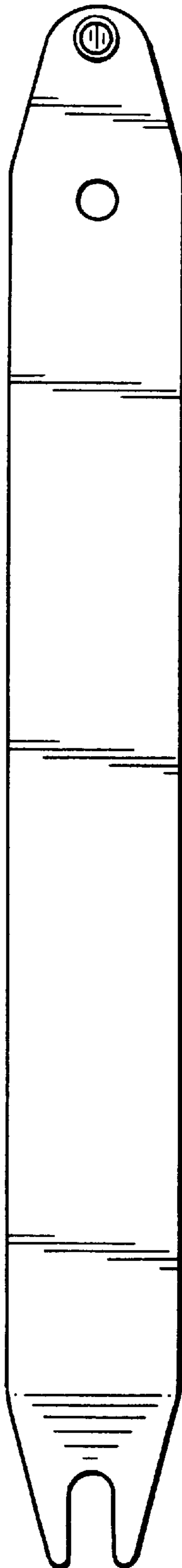

FIG. 11

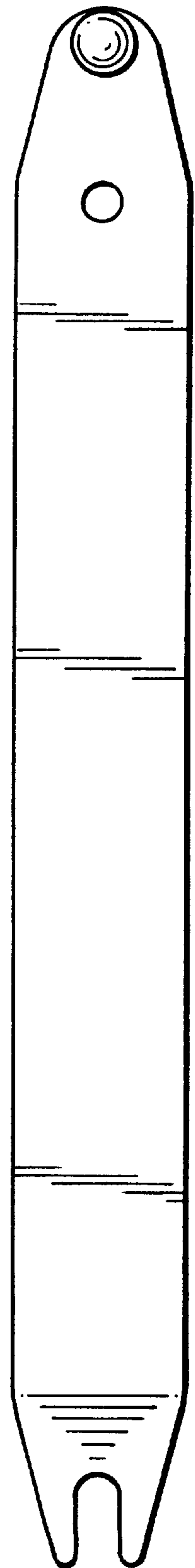

FIG. 12