



US00D410159S

# United States Patent [19] Wu

[11] Patent Number: Des. 410,159

[45] Date of Patent: \*\* May 25, 1999

[54] CHAIR ARM

5,577,804 11/1996 Tedesco ..... 297/344.19

[76] Inventor: **Chin-Chuan Wu**, No. 1, Lane 138,  
Chung Kang Road, Hsinchuang City,  
Taipei Hsien, Taiwan

### OTHER PUBLICATIONS

Sunar Catalog, p. 70, chair arm on the chair at the top and middle left of page, (c)1983.

[\*\*] Term: **14 Years**

*Primary Examiner*—Jeffrey Asch  
*Attorney, Agent, or Firm*—Rosenberg, Klein & Bilker

[21] Appl. No.: **29/087,240**

[22] Filed: **Apr. 29, 1998**

### [57] CLAIM

[51] LOC (6) Cl. .... **06-06**

[52] U.S. Cl. .... **D6/501; D6/366**

[58] Field of Search ..... D6/366–368, 500–502,  
D6/495, 498, 372, 373, 379, 364, 365;  
297/411.2, 411.4, 411.44, 411.36, 450.1,  
452.11, 452.21, 452.29, 463.1, 230.1, 230.12,  
284.1, 284.4

The ornamental design for a chair arm, as show and described.

### DESCRIPTION

### [56] References Cited

#### U.S. PATENT DOCUMENTS

D. 366,792	2/1996	McDiarmid	.....	D6/501
D. 367,983	3/1996	Olson	.....	D6/501
D. 368,817	4/1996	Schultz	.....	D6/501
D. 369,705	5/1996	George et al.	.....	D6/500
D. 382,738	8/1997	Chen	.....	D6/501
D. 383,931	9/1997	Schultz et al.	.....	D6/501
D. 387,917	12/1997	Tedesco et al.	.....	D6/366
D. 388,269	12/1997	Tedesco et al.	.....	D6/501
D. 393,157	4/1998	Goodworth	.....	D6/366

FIG. 1 is a perspective view of a chair arm showing my new design;  
FIG. 2 is a front view thereof;  
FIG. 3 is a rear view thereof;  
FIG. 4 is a right side elevational view thereof;  
FIG. 5 is a left side elevational view thereof;  
FIG. 6 is a top plan view thereof;  
FIG. 7 is a bottom plan view thereof;  
FIG. 8 is cross-sectional view taken along the line 8—8 of FIG. 4;  
FIG. 9 is cross-sectional view taken along the line 9—9 of FIG. 4; and,  
FIG. 10 is cross-sectional view taken along the line 10—10 of FIG. 4.

**1 Claim, 6 Drawing Sheets**

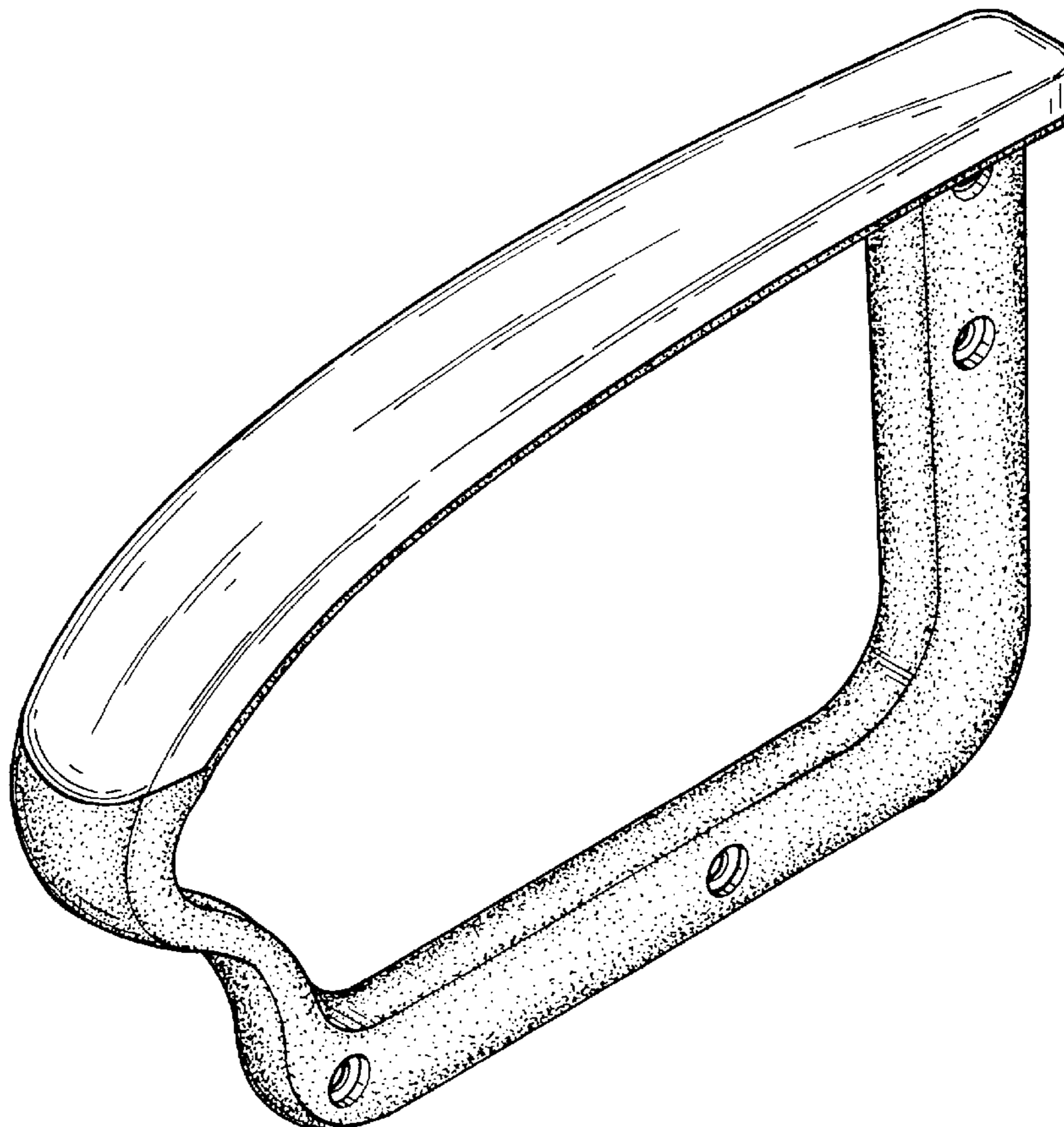

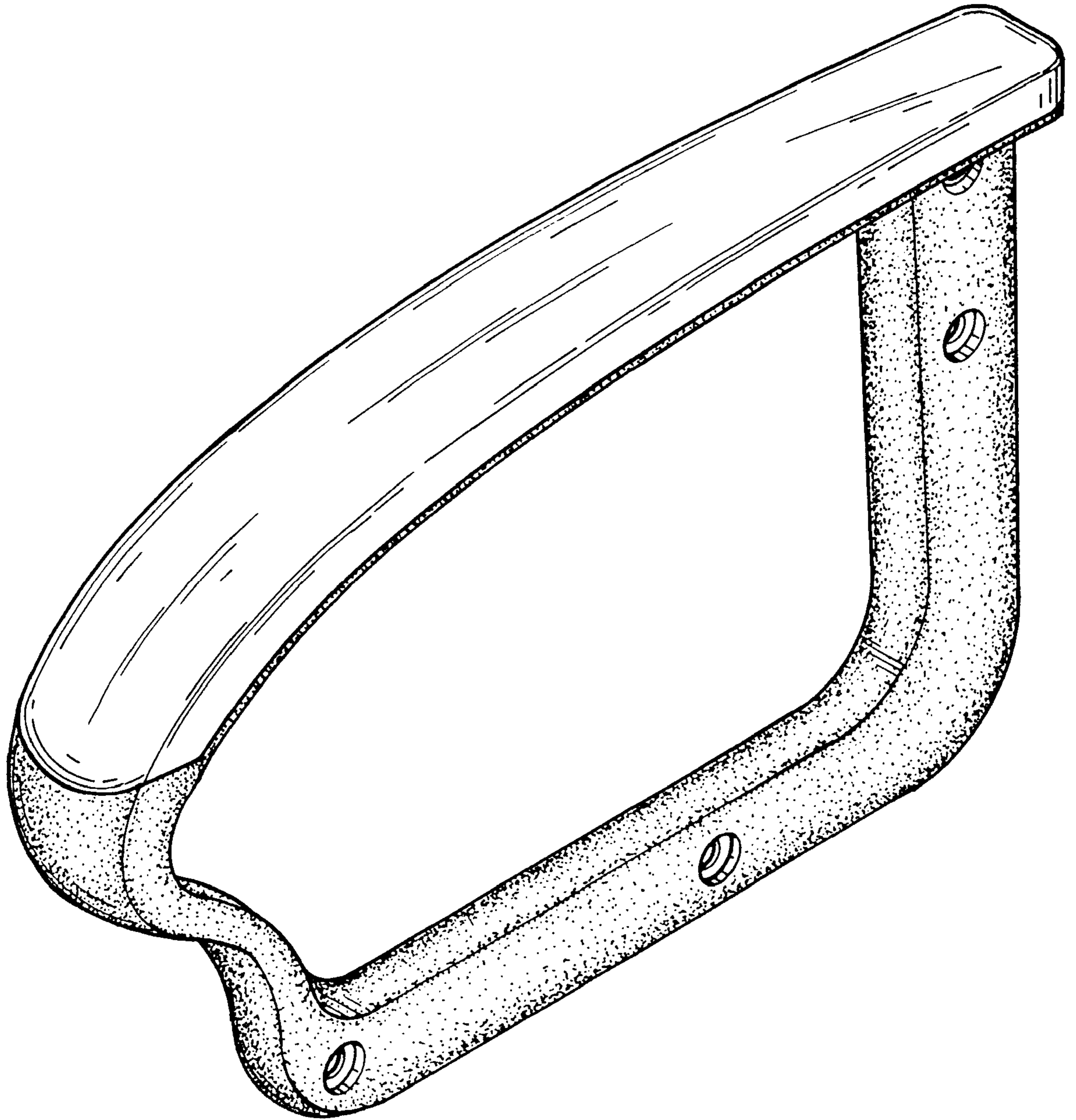

FIG. 1

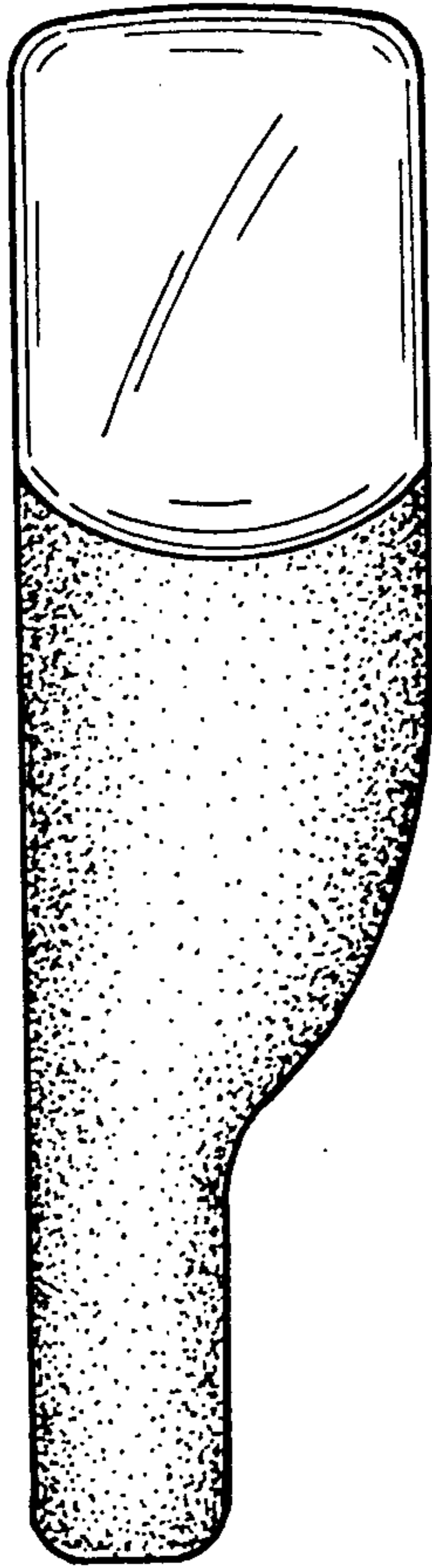

FIG. 2

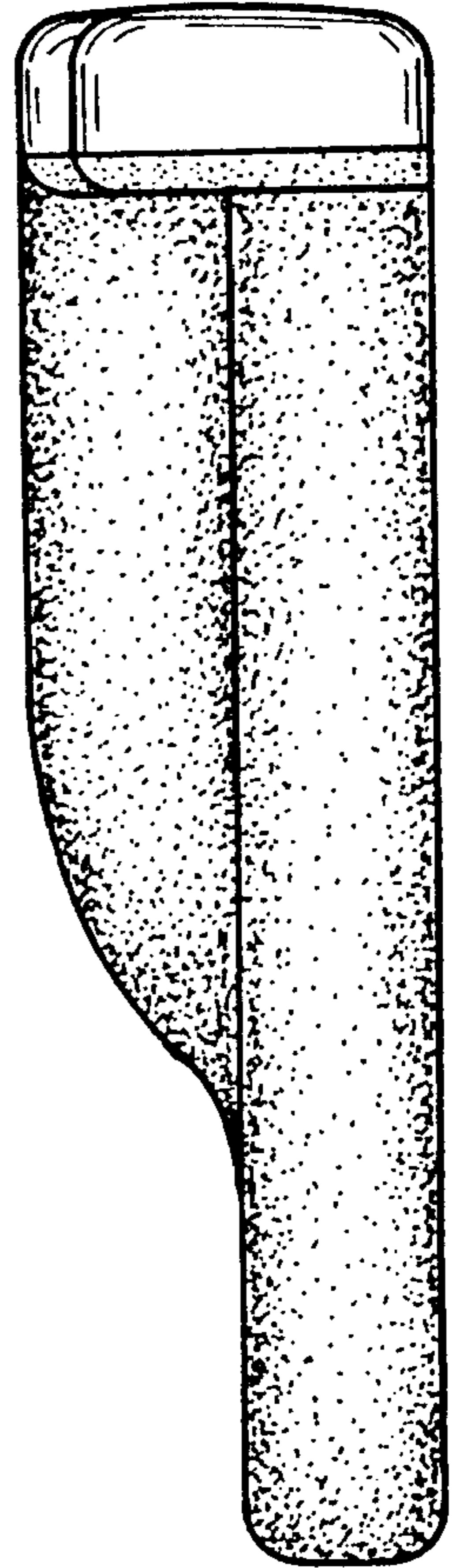

FIG. 3

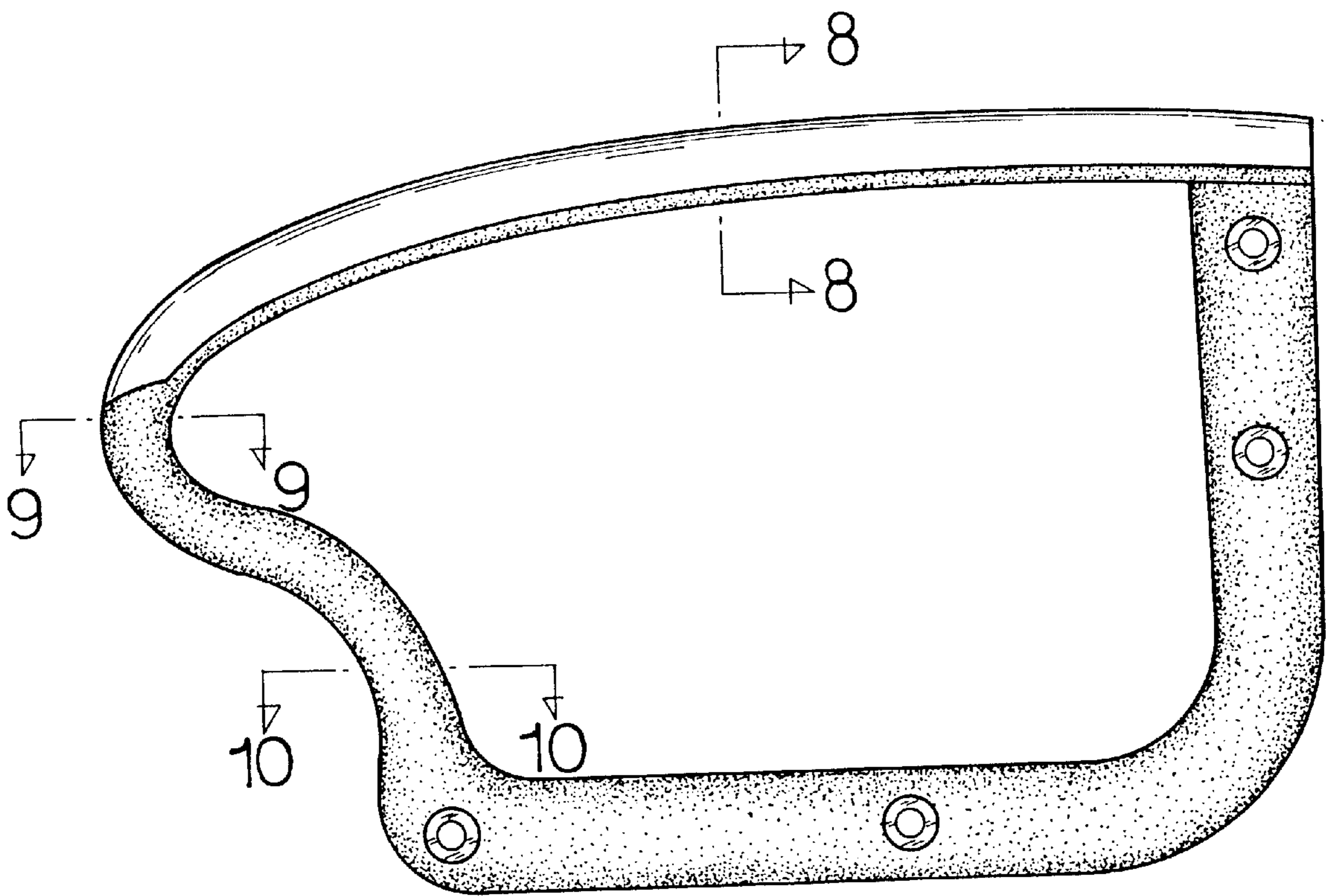

FIG. 4

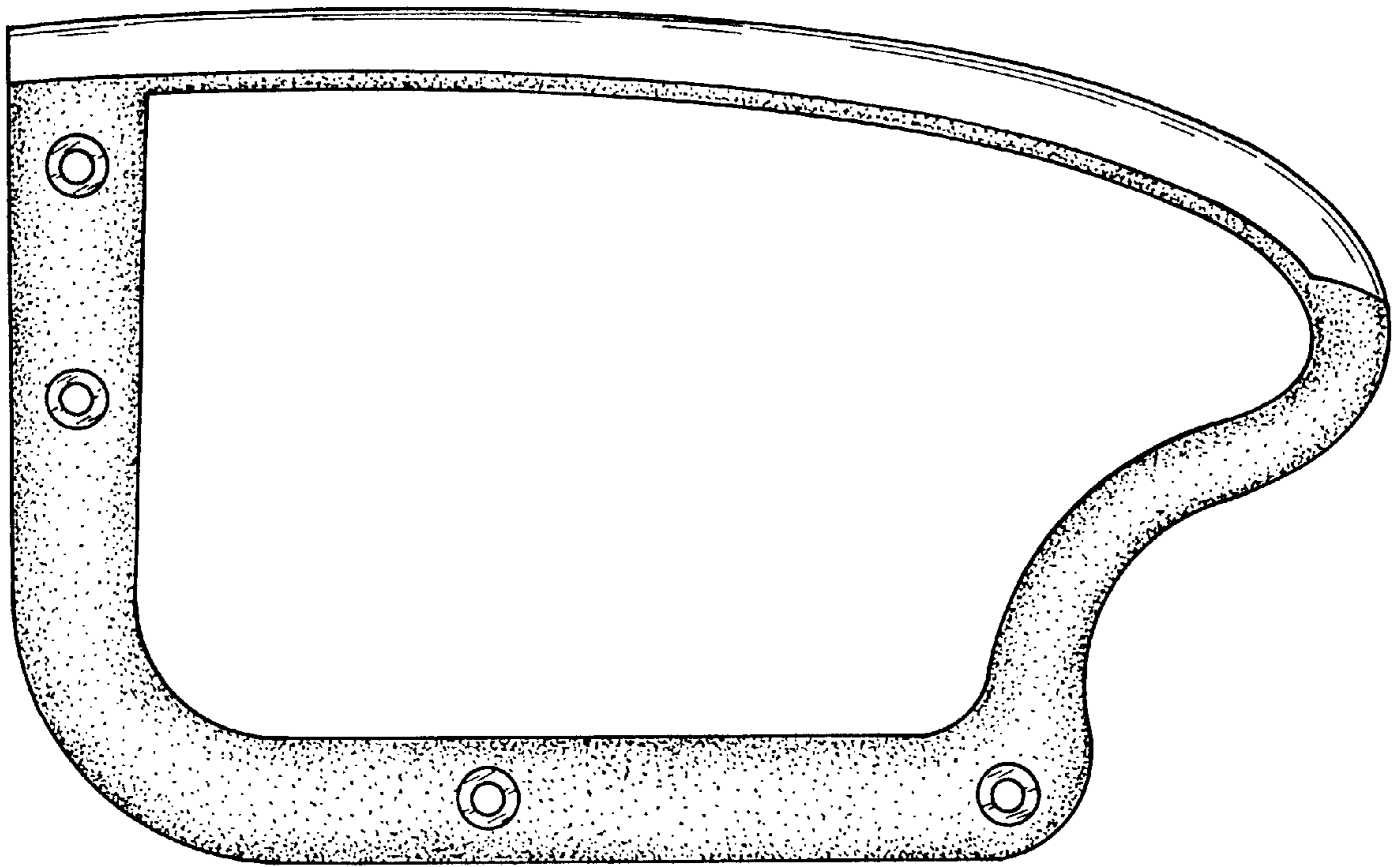

FIG. 5

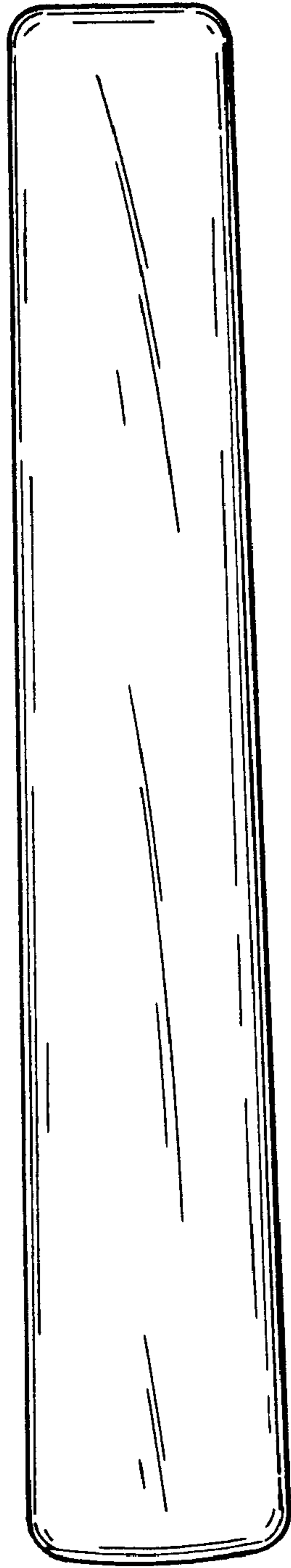

FIG. 6

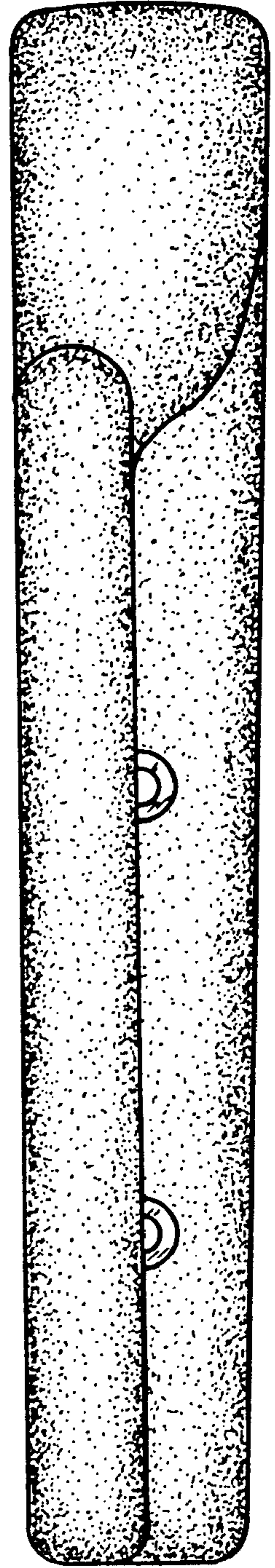

FIG. 7

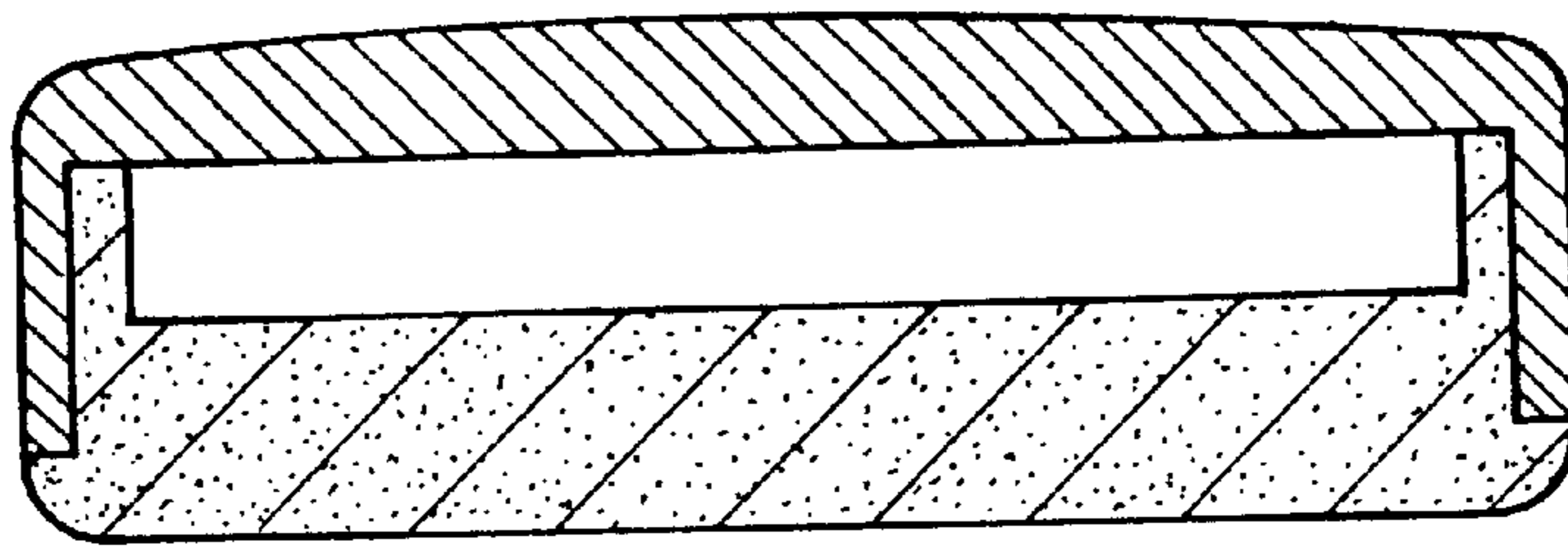

FIG. 8

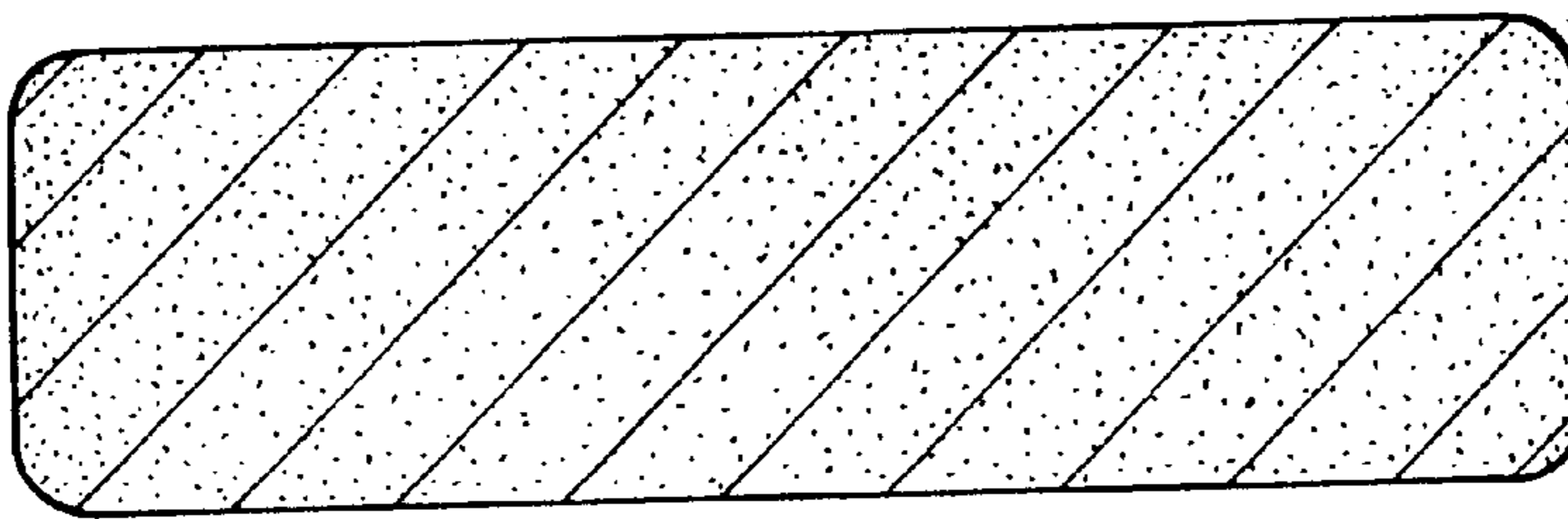

FIG. 9

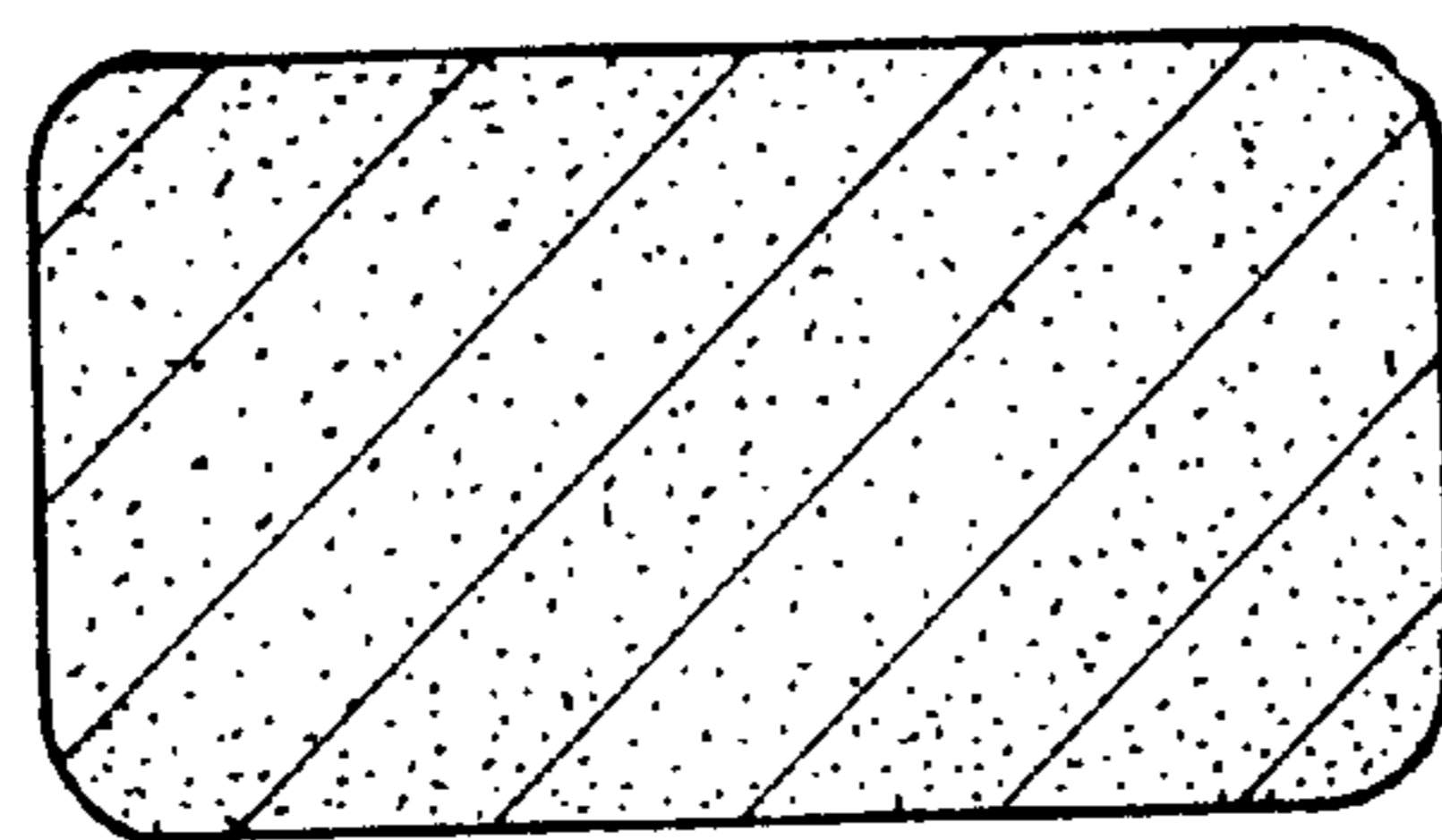

FIG. 10