



US00D410019S

United States Patent [19]

[11] Patent Number: **Des. 410,019**

Shimobayashi et al.

[45] Date of Patent: **** May 18, 1999**

[54] **35MM CAMERA**

[75] Inventors: **Kouji Shimobayashi; Hiroyuki Ando,**
both of Hachiouji, Japan

[73] Assignee: **Olympus Optical Co. Ltd.,** Tokyo,
Japan

[**] Term: **14 Years**

[21] Appl. No.: **29/093,117**

[22] Filed: **Sep. 3, 1998**

[51] **LOC (6) Cl.** **16-01**

[52] **U.S. Cl.** **D16/209; D16/212**

[58] **Field of Search** **D16/200-205,**
D16/208, 209, 211-213, 216-218; 396/348,
349, 535-543

[56] **References Cited**

U.S. PATENT DOCUMENTS

D. 323,336	1/1992	Moro et al.	D16/212
D. 369,372	4/1996	Ishikawa et al.	D16/218
D. 389,849	1/1998	Kim	D16/212
D. 392,660	3/1998	Kim et al.	D16/209
4,219,265	8/1980	Waaske	396/349

OTHER PUBLICATIONS

Olympus catalog of [mju:] Zoom 115.

Copy of page of magazine entitled Shashin Kogyo (Photographic Industry) described as Olympus Zoom 115.

Primary Examiner—Adir Aronovich

Attorney, Agent, or Firm—Laff, Whitesel, Conte & Saret, Ltd.

[57] **CLAIM**

The ornamental design for a 35mm camera, as shown and described.

DESCRIPTION

FIG. 1 is a front, top and left side perspective view of 35mm camera, showing our new design;

FIG. 2 is a front elevational view thereof;

FIG. 3 is a bottom plan view thereof;

FIG. 4 is a top plan view thereof;

FIG. 5 is a rear elevational view thereof;

FIG. 6 is a right side elevational view thereof;

FIG. 7 is a left side elevational view thereof;

FIG. 8 is a top plan view with a cover in an opened state and a lens-barrel extended; and,

FIG. 9 is a front elevational view thereof with a cover in an opened state and an electronic flashing unit set in a raised state.

1 Claim, 5 Drawing Sheets

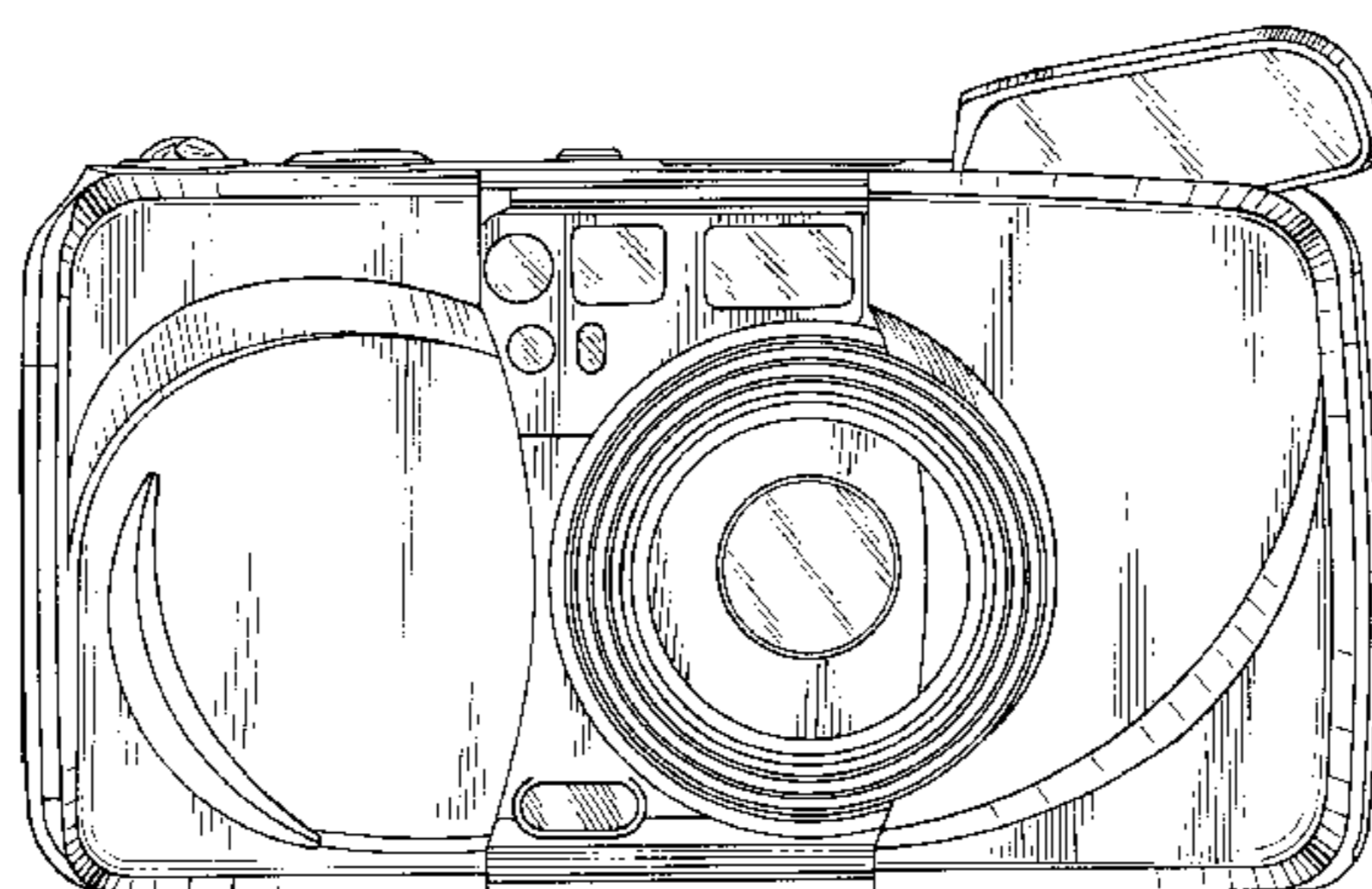
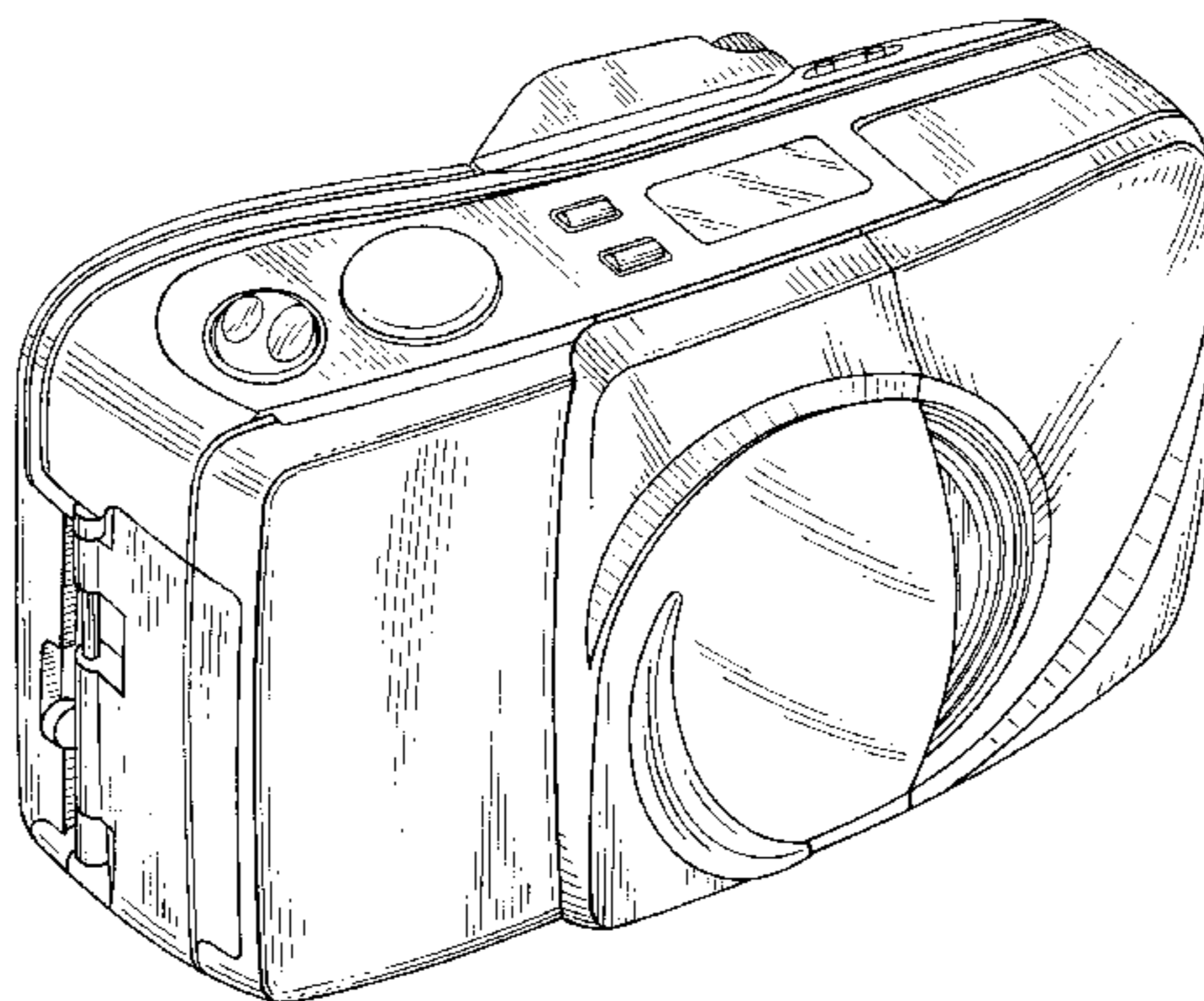

FIG.1

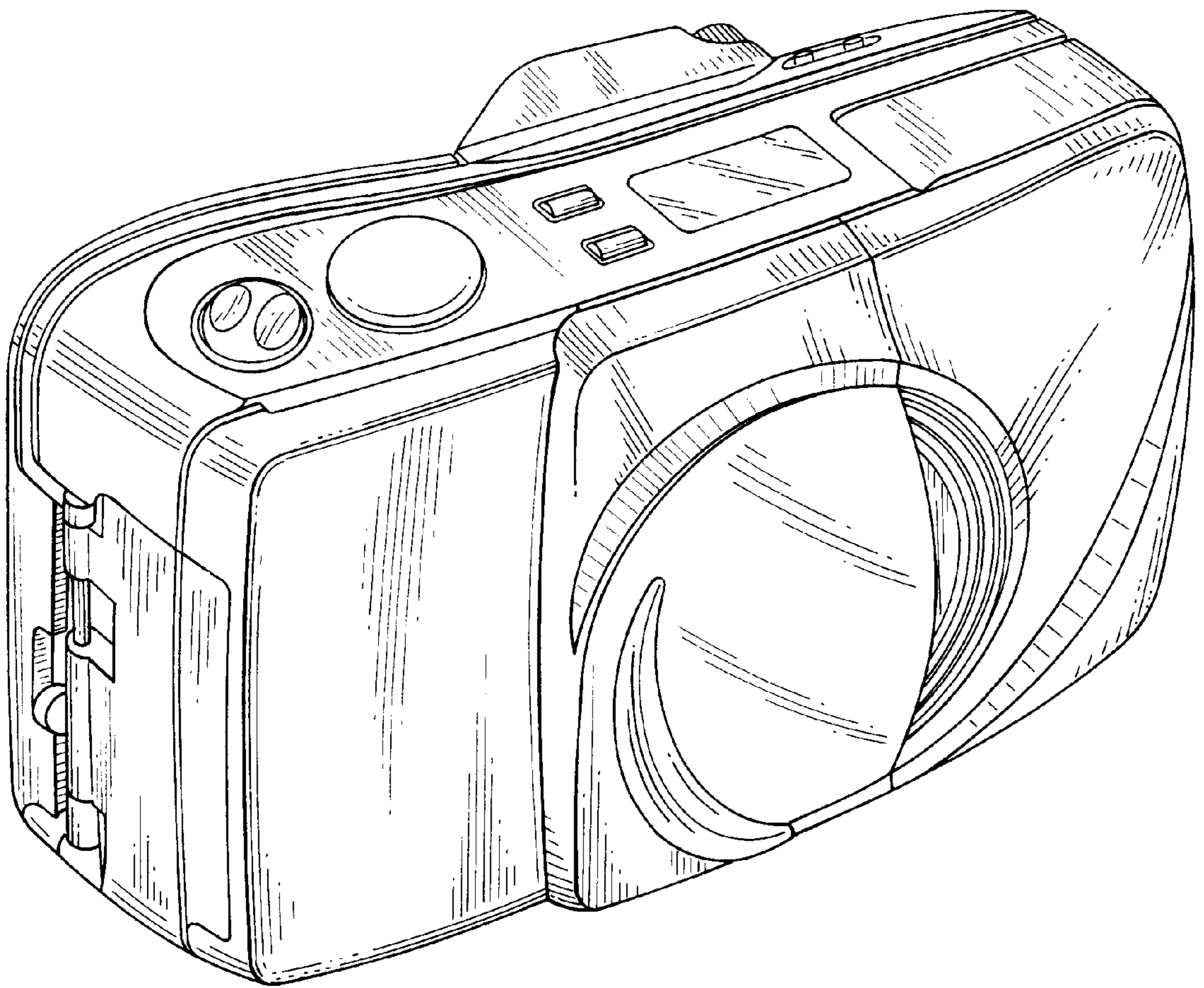

FIG.2

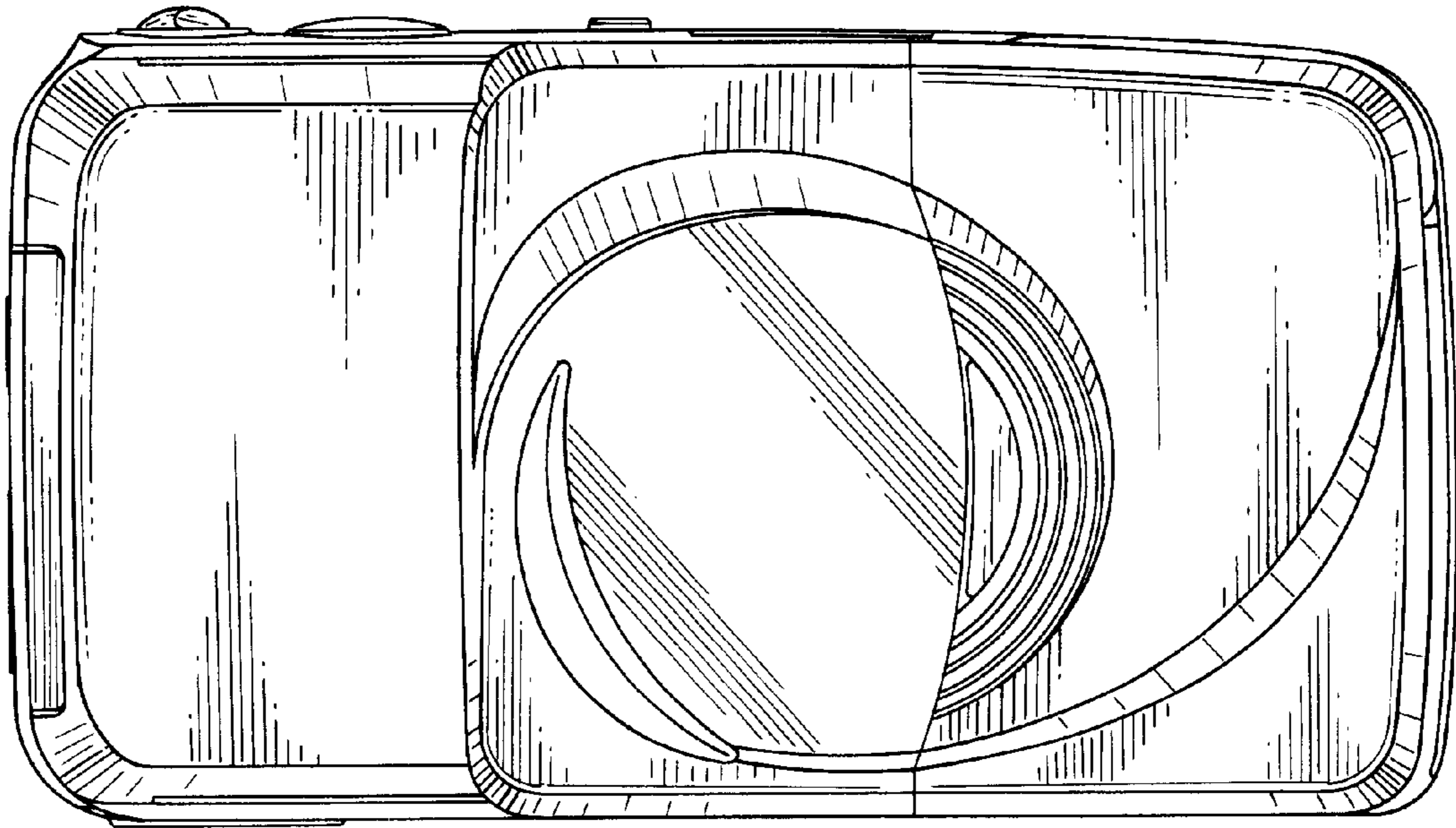

FIG.3

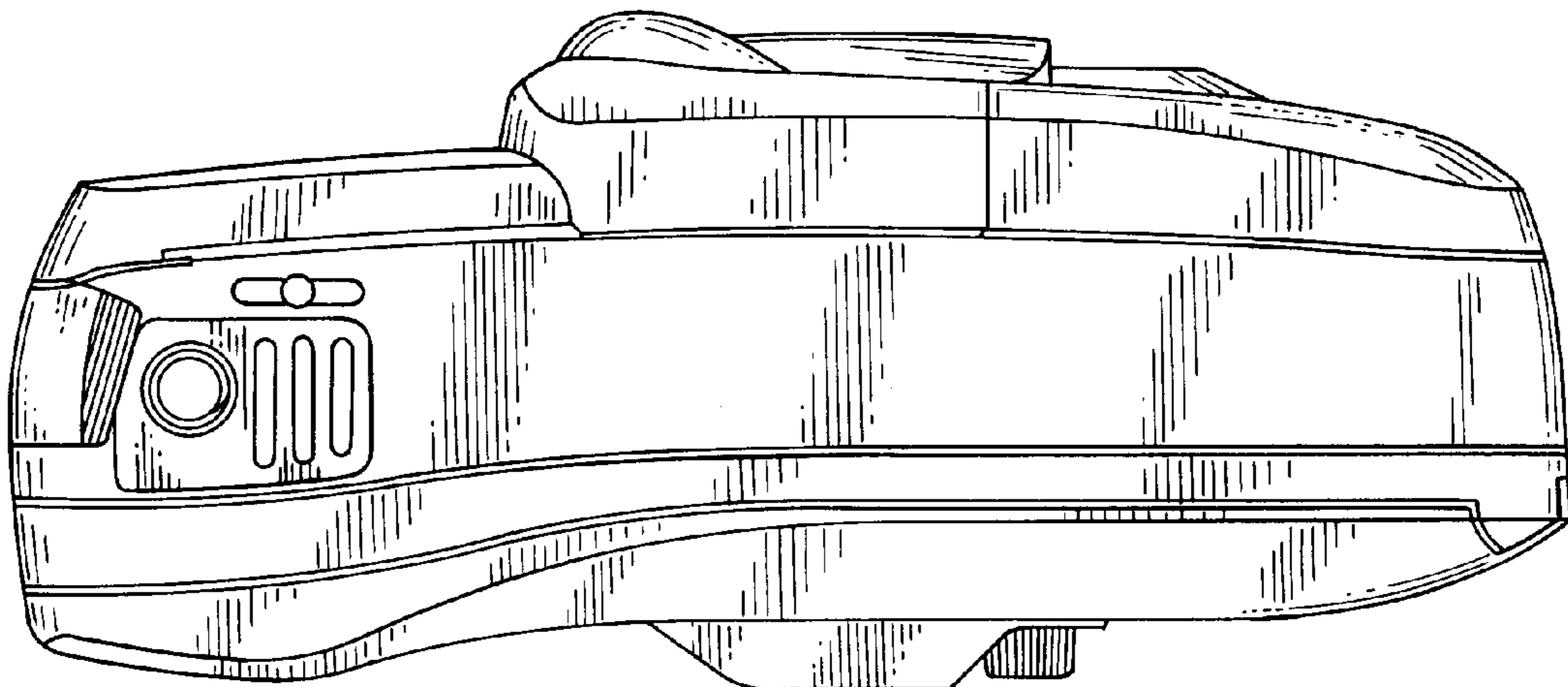

FIG.4

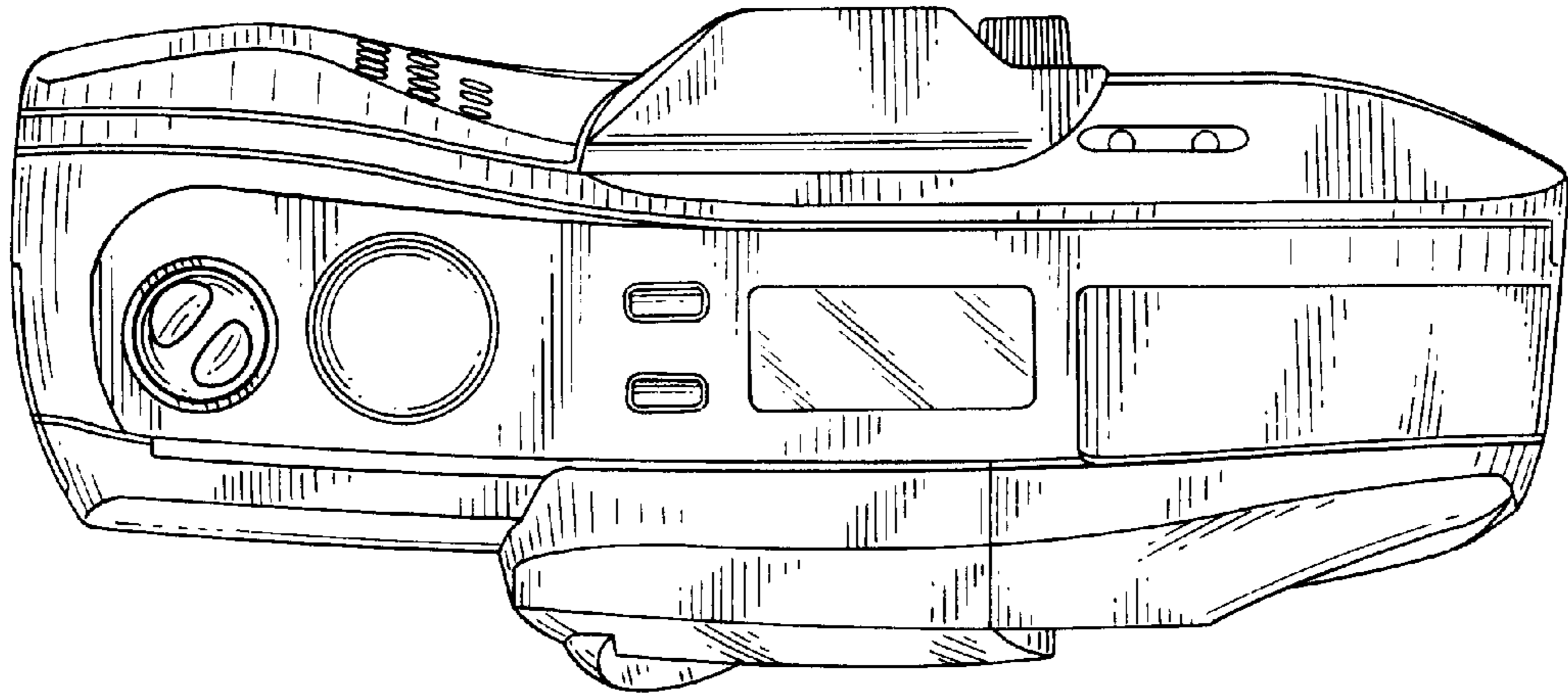

FIG.5

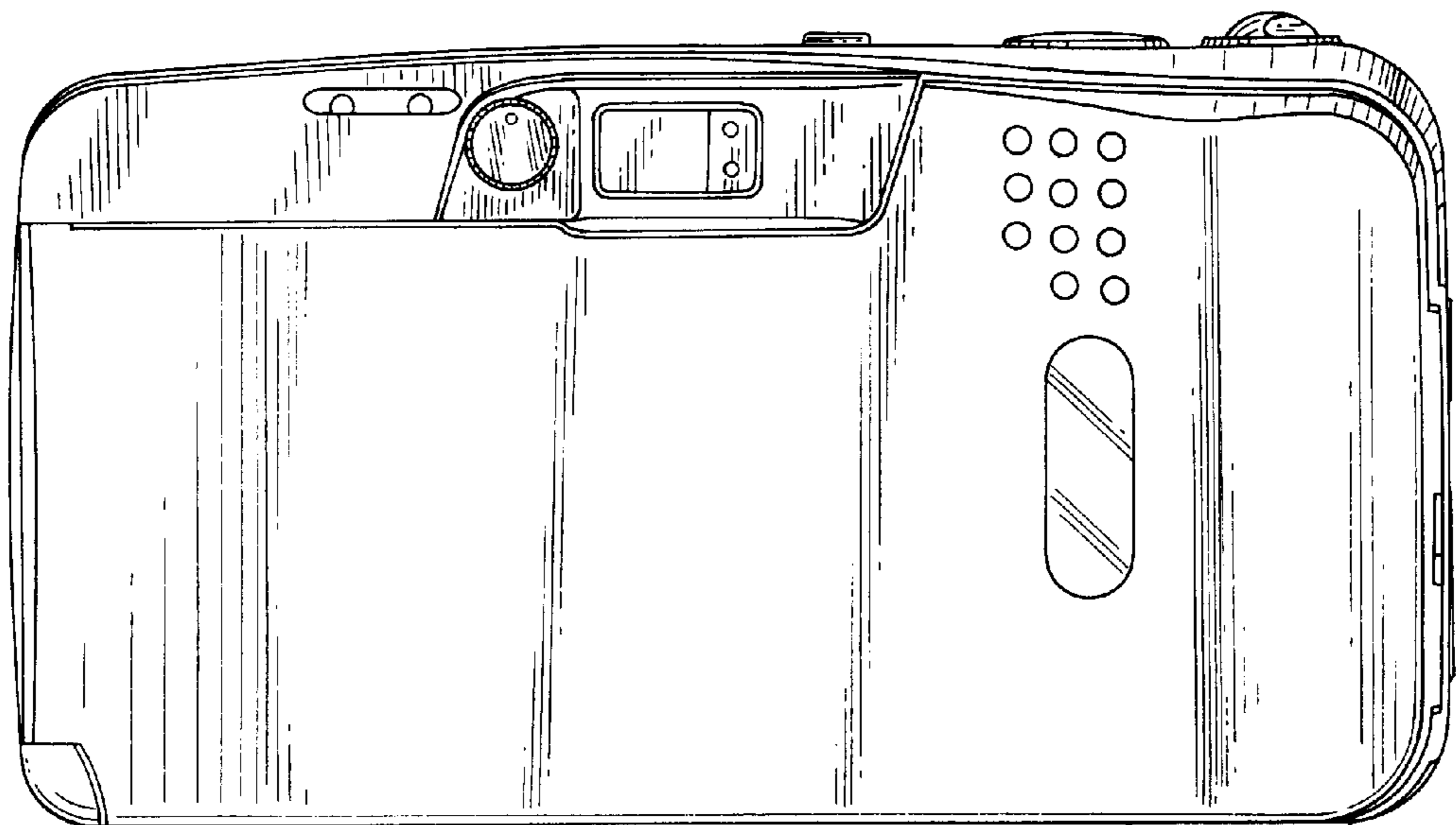

FIG.6

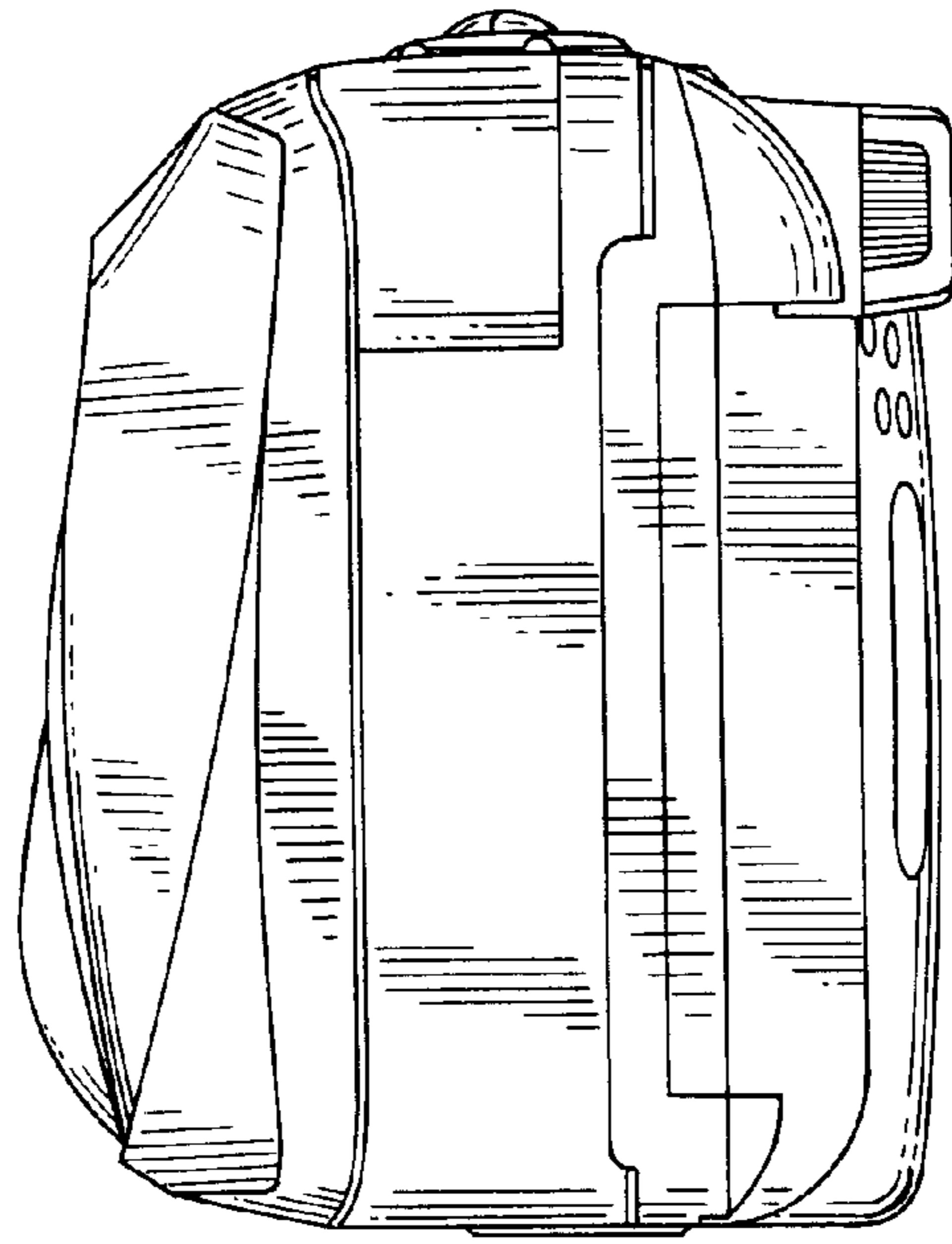

FIG.7

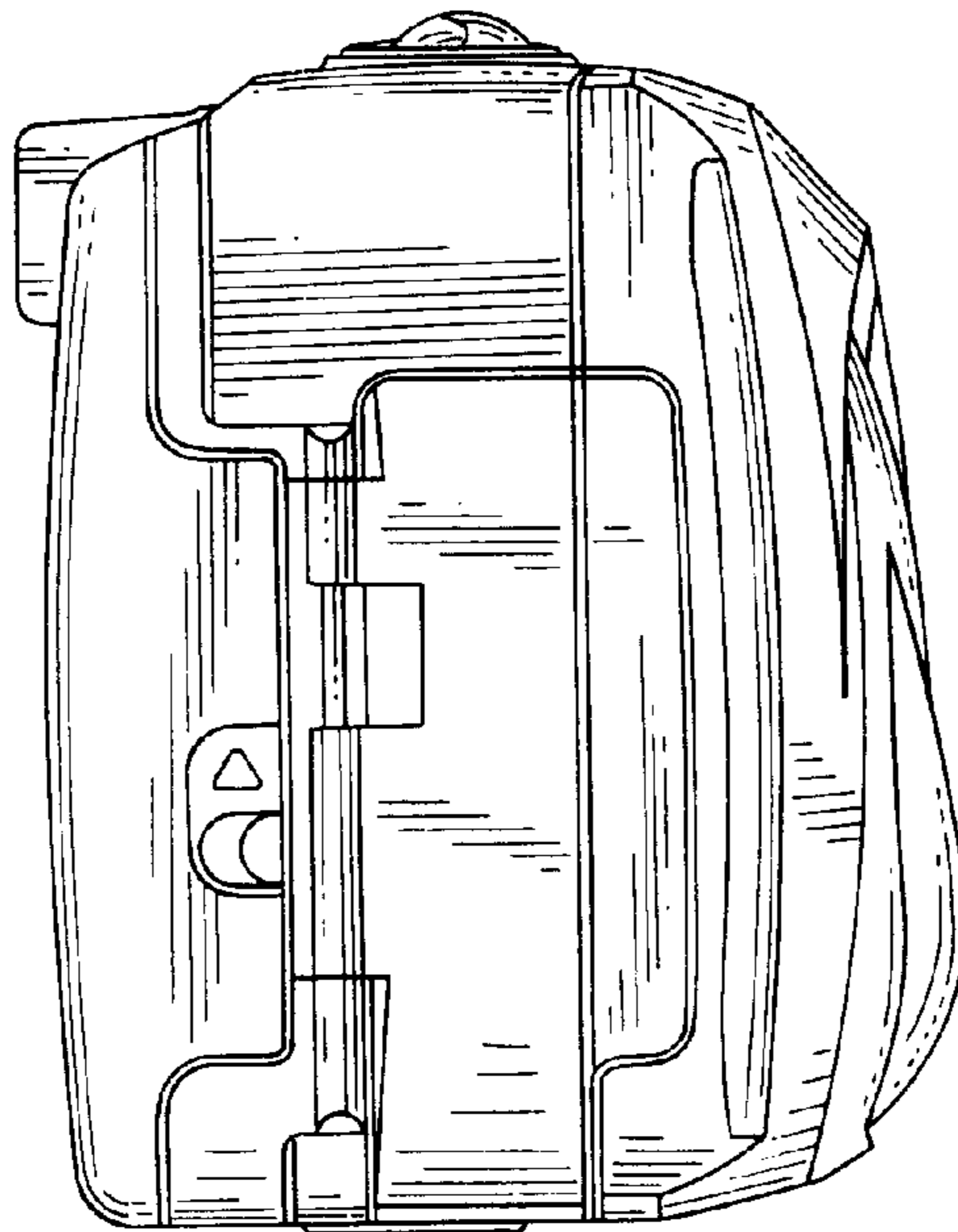

FIG.8

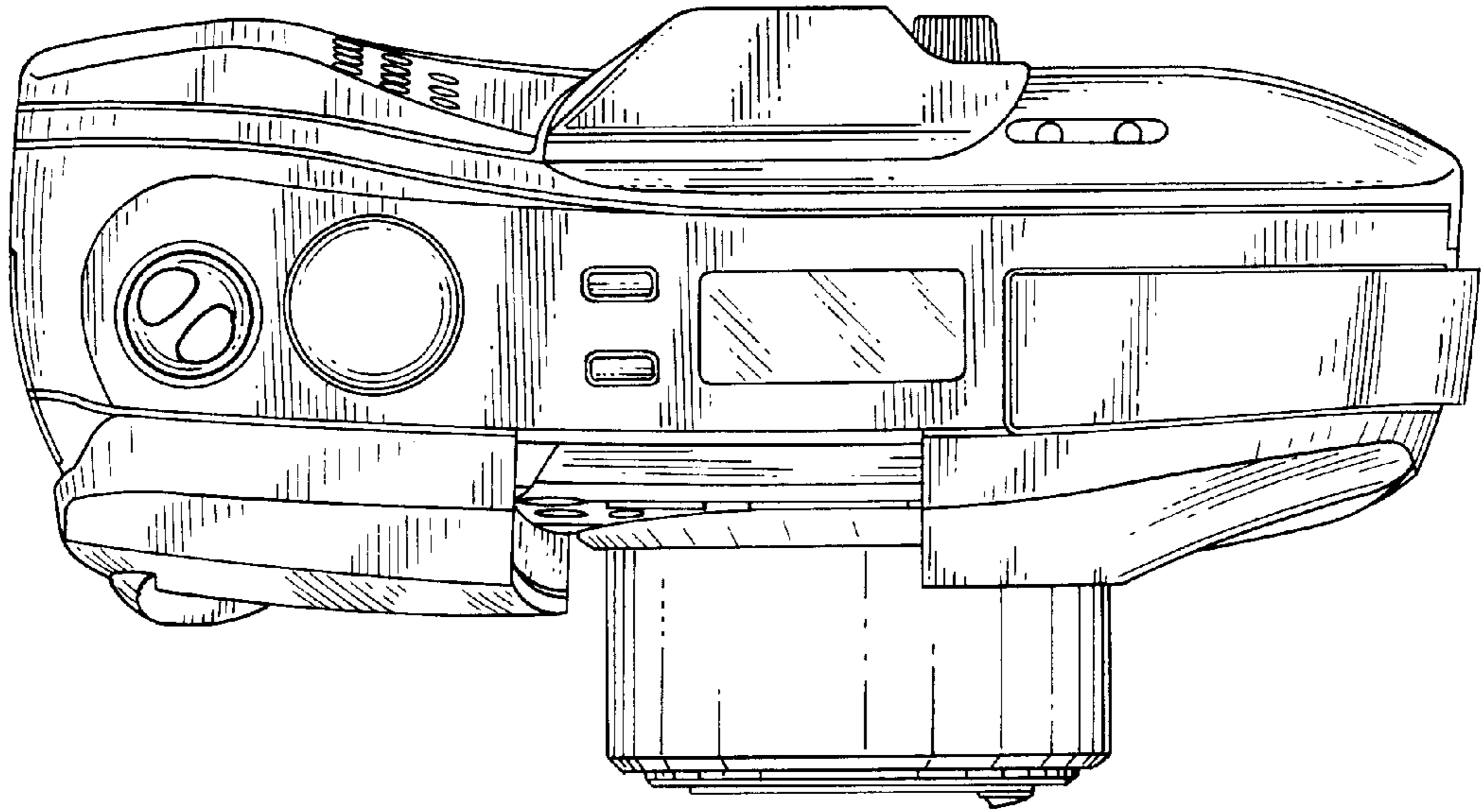

FIG.9

