



US00D410013S

United States Patent [19]

[11] Patent Number: **Des. 410,013**

Takasago et al.

[45] Date of Patent: **** May 18, 1999**

[54] REFRIGERATOR

823090-5 2/1995 Japan .
928914 6/1995 Japan .

[75] Inventors: **Hideyuki Takasago; Aya Sawai; Wataru Yamada; Masataka Nagahori; Naoto Higuchi**, all of Kanagawa, Japan

OTHER PUBLICATIONS

Catalogue of Refrigerators, 17 pages, undated.

[73] Assignee: **Mitsubishi Denki Kabushiki Kaisha**, Tokyo, Japan

Primary Examiner—Sandra L. Morris
Attorney, Agent, or Firm—Oblon, Spivak, McClelland, Maier & Neustadt, P.C.

[**] Term: **14 Years**

[57] CLAIM

[21] Appl. No.: **29/087,403**

The ornamental design for a refrigerator, as shown and described.

[22] Filed: **May 1, 1998**

DESCRIPTION

[30] Foreign Application Priority Data

Dec. 25, 1997 [JP] Japan 9-79801

[51] **LOC (6) Cl.** **15-07**

[52] **U.S. Cl.** **D15/86**

[58] **Field of Search** D15/79, 81, 85-88;
62/125-127; 312/139.2, 236

FIG. 1 is a front, top and left side perspective view of a refrigerator, showing our new design;
FIG. 2 is a front elevational view thereof;
FIG. 3 is a rear elevational view thereof;
FIG. 4 is a left side elevational view thereof;
FIG. 5 is a right side elevational view thereof;
FIG. 6 is a top plan view thereof;
FIG. 7 is a bottom plan view thereof;
FIG. 8 is an expanded cross-sectional view thereof, taken along line 8—8 in FIG. 2, with the internal system omitted;
FIG. 9 is an expanded cross-sectional view thereof, taken along line 9—9 in FIG. 2, with the internal system omitted;
FIG. 10 is an expanded cross-sectional view thereof, taken along line 10—10 in FIG. 2, with the internal system omitted;
FIG. 11 is an expanded cross-sectional view thereof, taken along line 11—11 in FIG. 2, with the internal system omitted;
FIG. 12 is an expanded view of portion 12 in FIG. 8;
FIG. 13 is an expanded view of portion 13 in FIG. 8;
FIG. 14 is an expanded view of portion 14 in FIG. 11;
FIG. 15 is a front elevational view thereof, with the top doors shown opened; and,
FIG. 16 is a front, top and left side perspective view thereof, with the lower doors pulled out.
The features shown in phantom line in FIG. 8 are for illustrative purposes only and form no part of the claimed design.

[56] References Cited

U.S. PATENT DOCUMENTS

- D. 190,453 5/1961 Munz et al. D15/86
- D. 210,560 3/1968 Kennedy et al. D15/86
- D. 236,654 9/1975 Meyer D15/86
- D. 299,145 12/1988 Kuwabara et al. D15/86
- 3,070,852 1/1963 Hilliker D15/85

FOREIGN PATENT DOCUMENTS

- 804270 1/1991 Japan .
- 804273 1/1991 Japan .
- 804277 1/1991 Japan .
- 804279 1/1991 Japan .
- 823089 11/1991 Japan .
- 823090 11/1991 Japan .
- 852944 11/1992 Japan .
- 804279-1 2/1994 Japan .
- 823090-1 2/1994 Japan .
- 823090-2 2/1994 Japan .
- 823090-3 2/1994 Japan .
- 804277-1 6/1994 Japan .
- 804279-2 2/1995 Japan .
- 823090-4 2/1995 Japan .

1 Claim, 11 Drawing Sheets

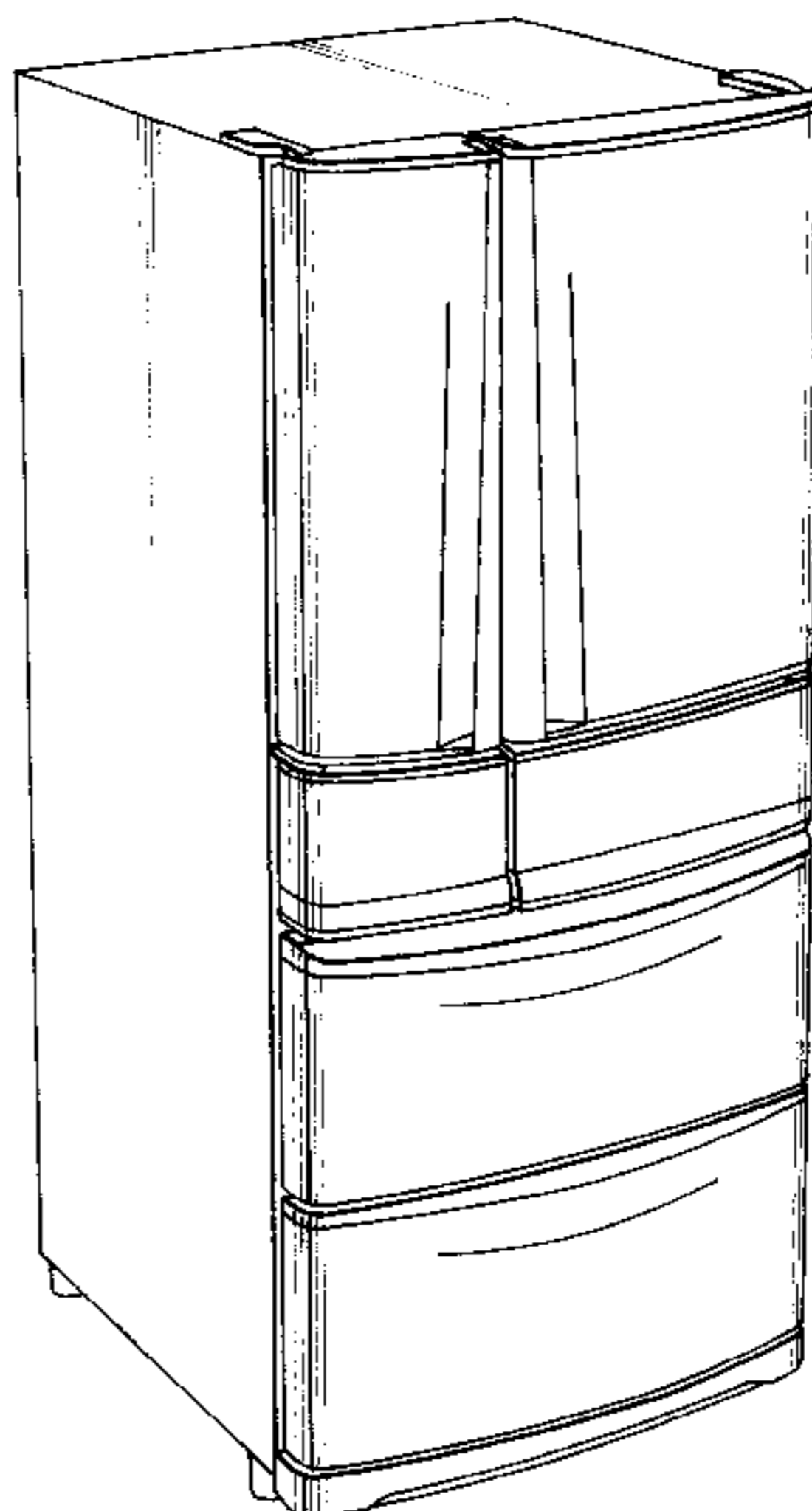

FIG. 1

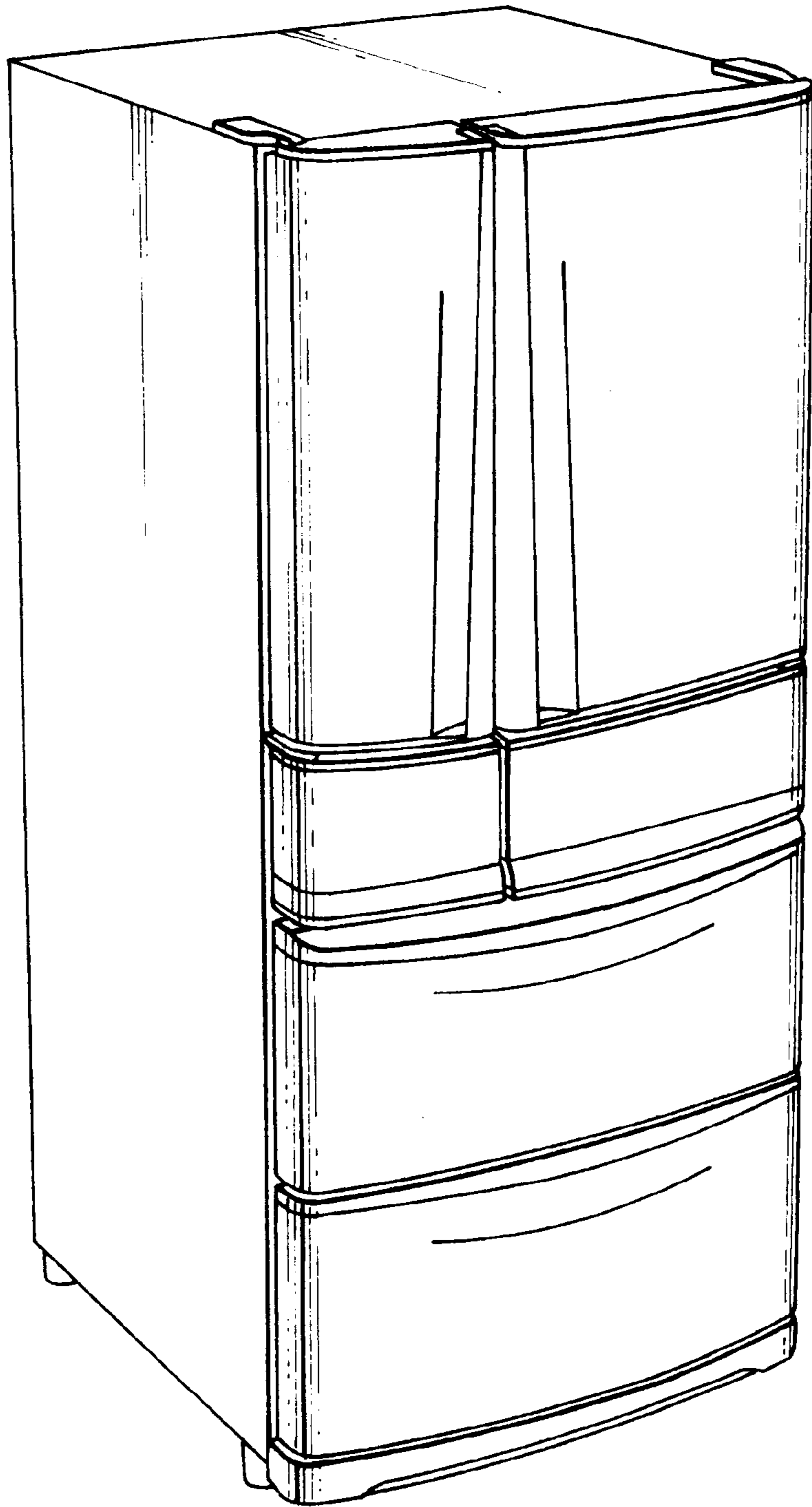

FIG. 2

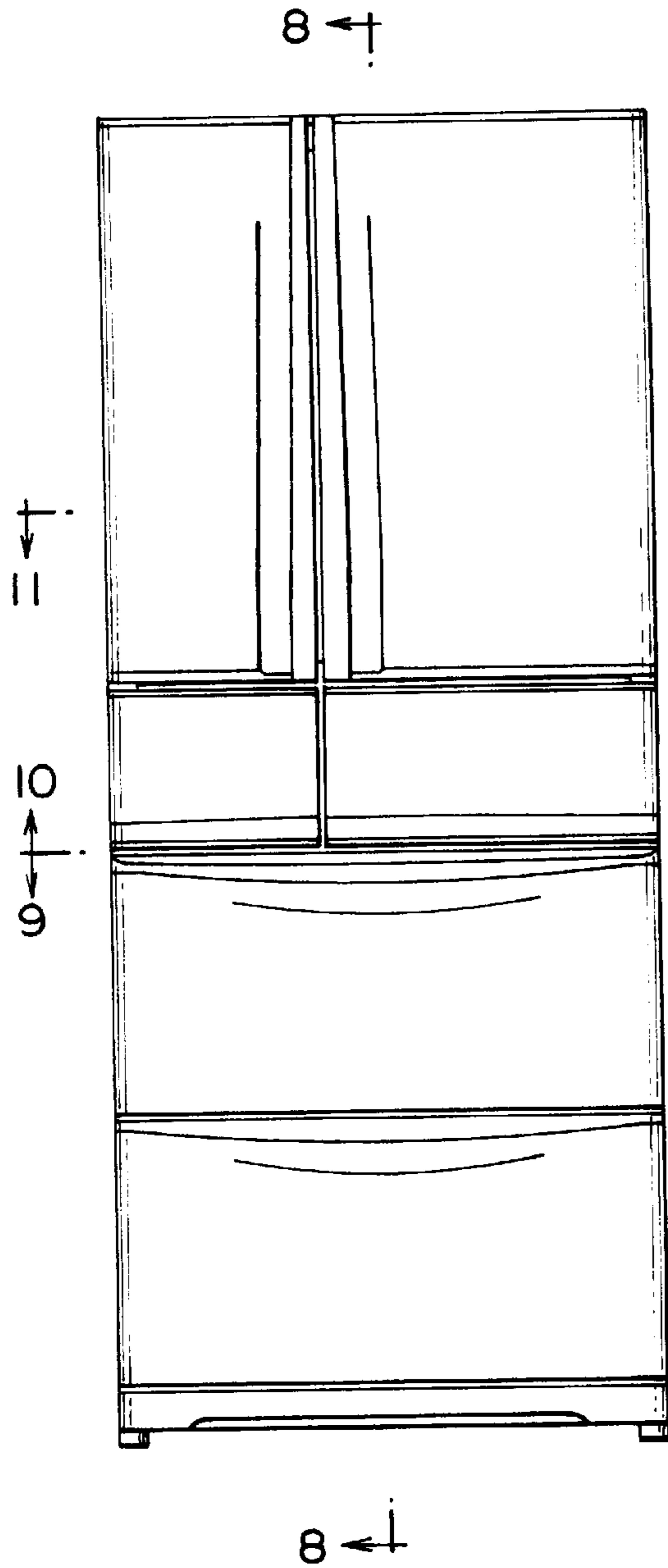

FIG. 3

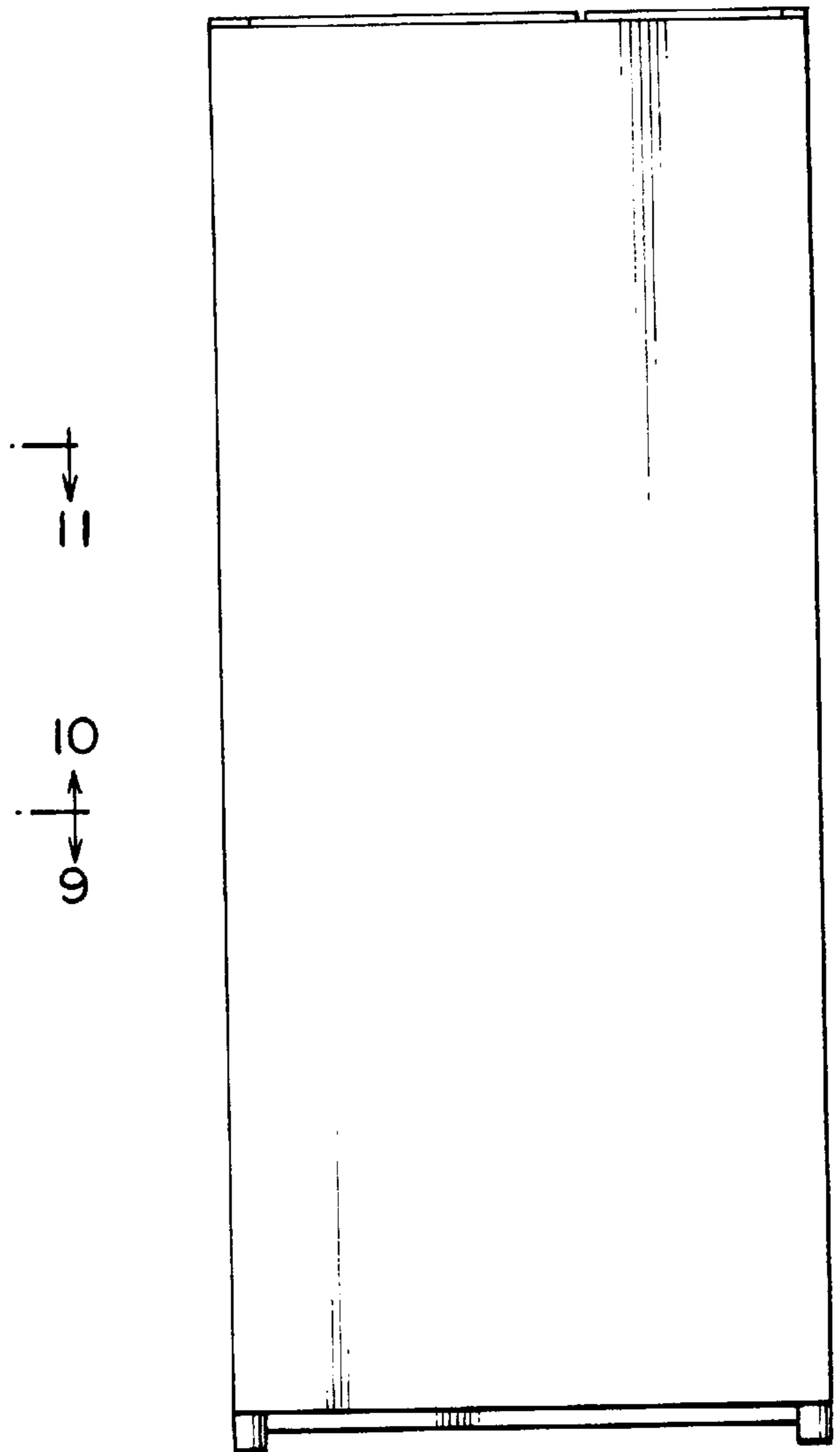

FIG. 4

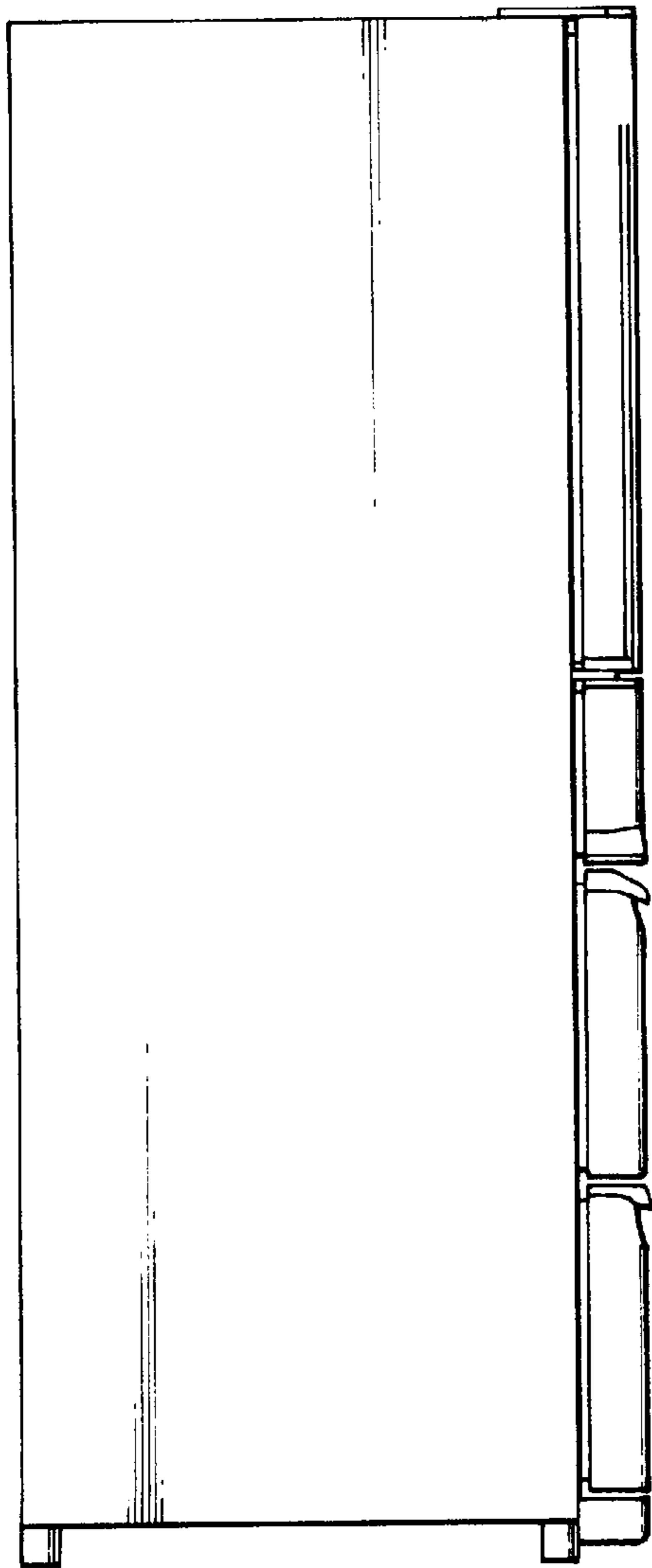

FIG. 5

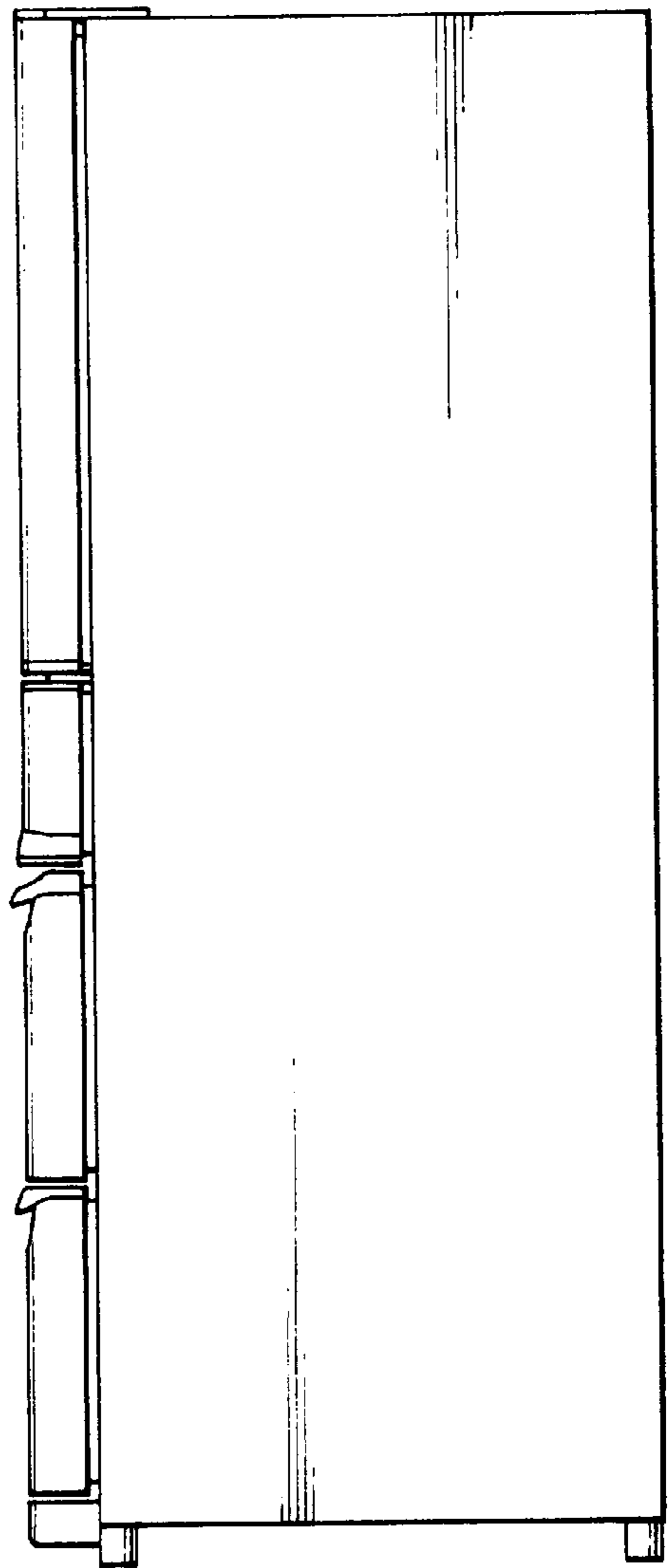

FIG. 6

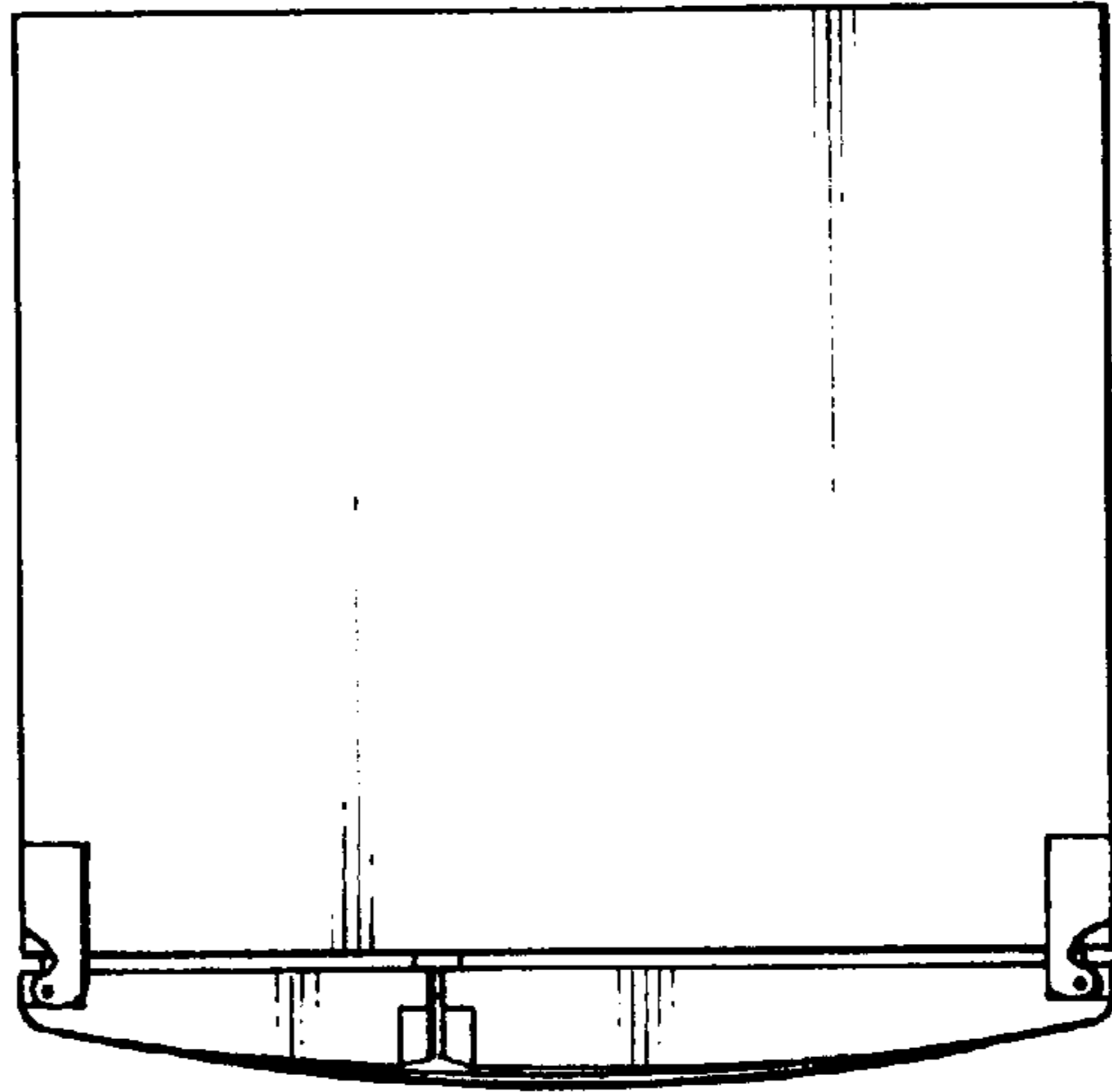
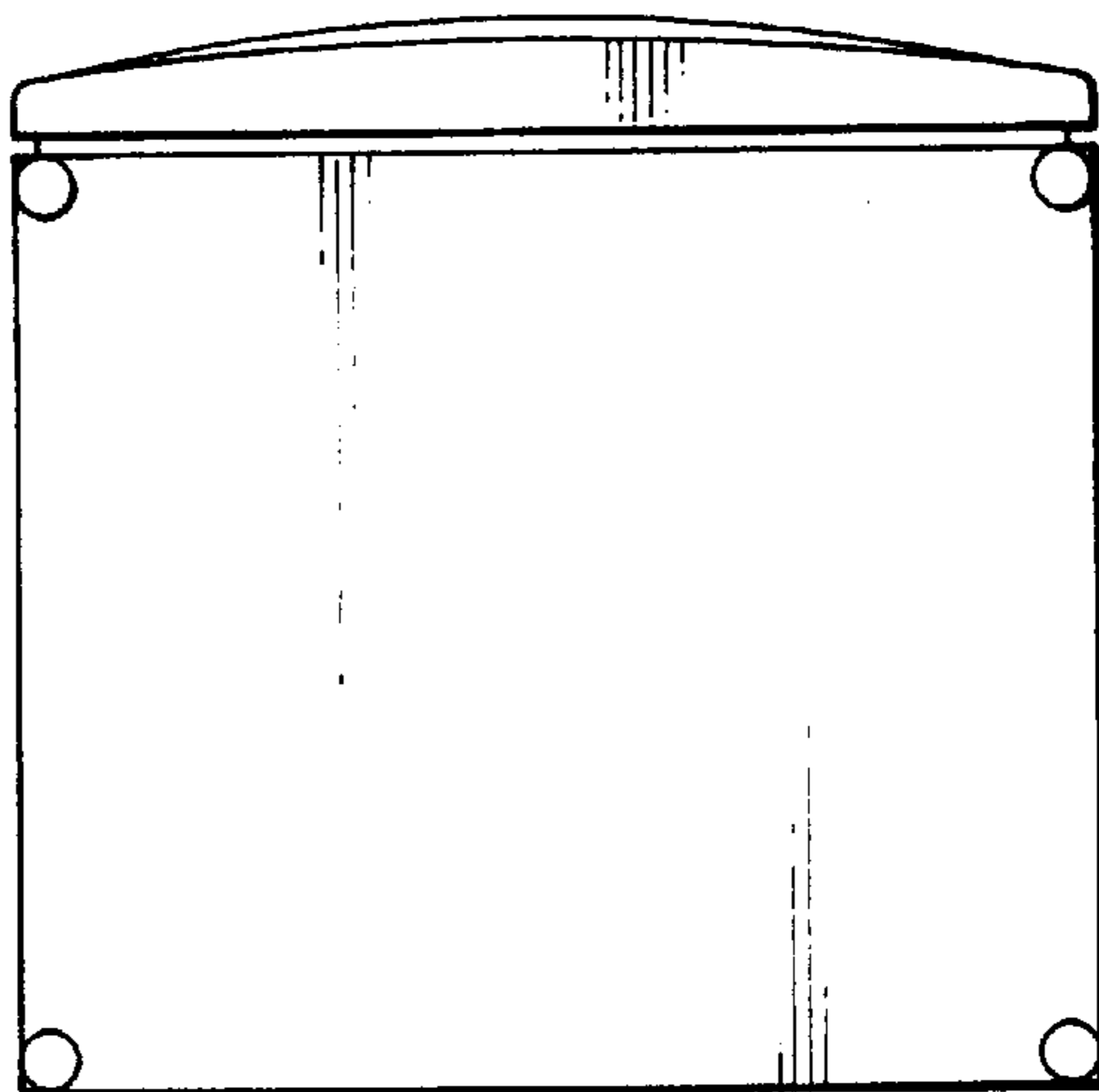

FIG. 7



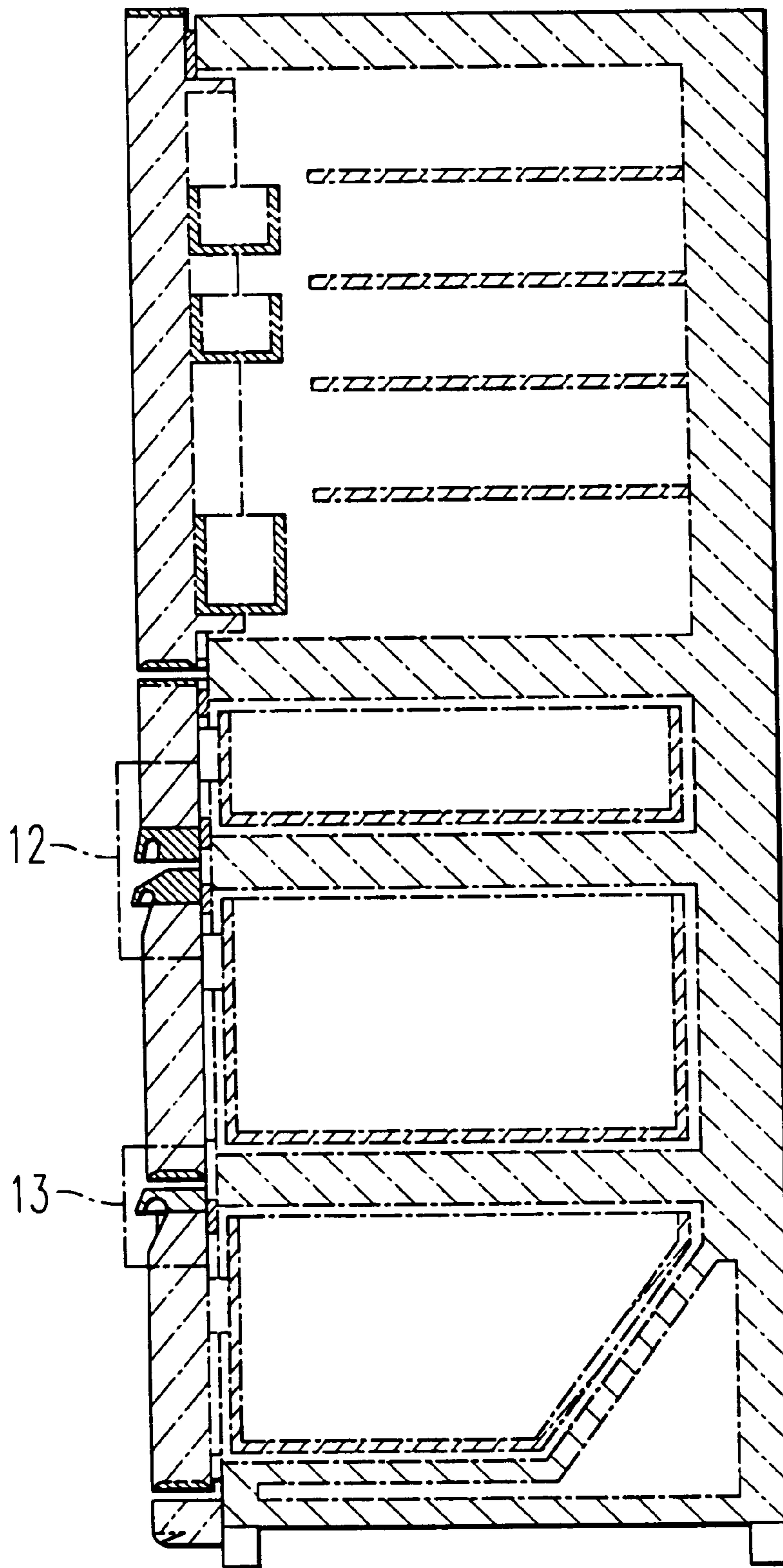

FIG. 8

FIG. 9

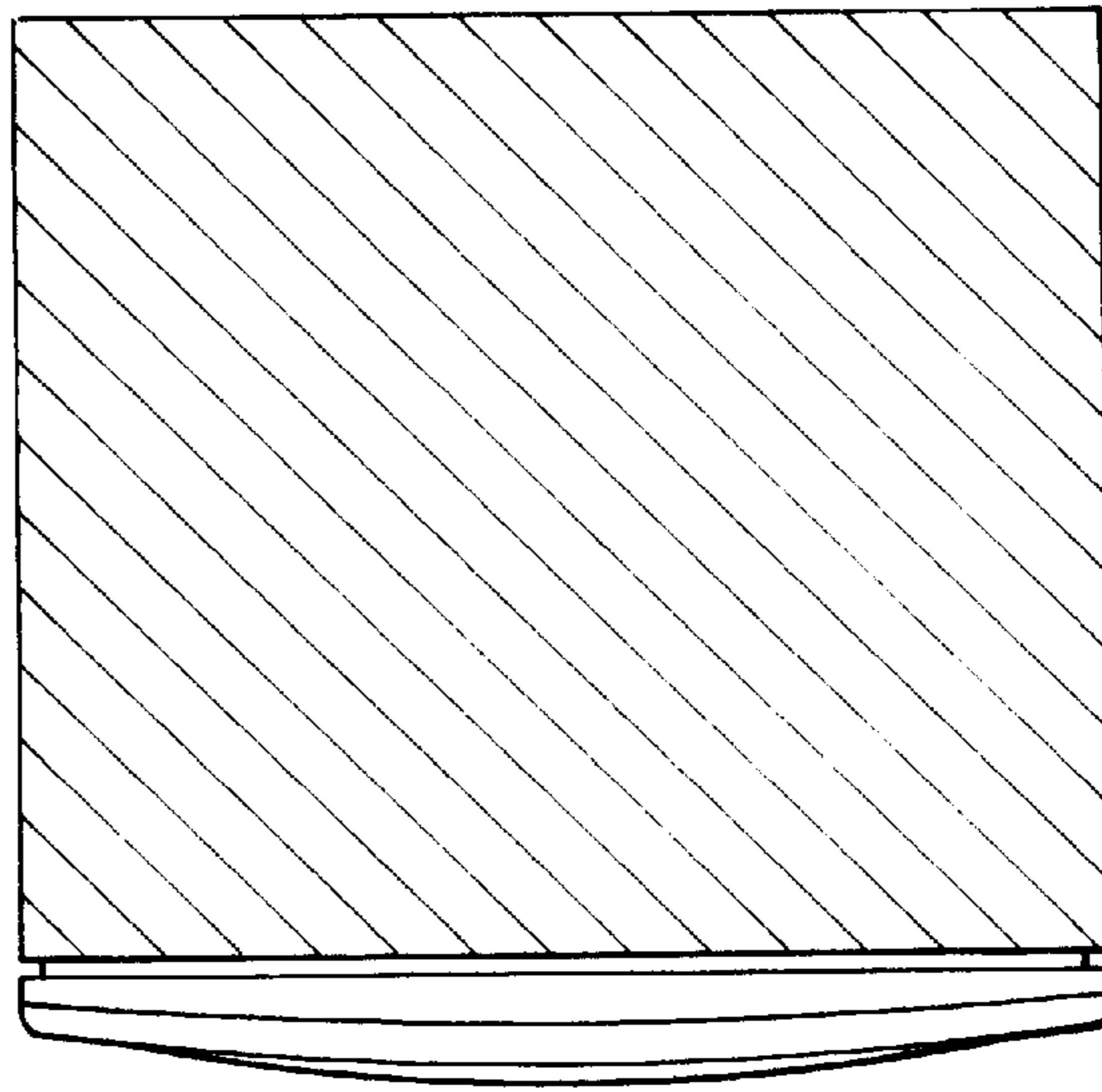

FIG. 10

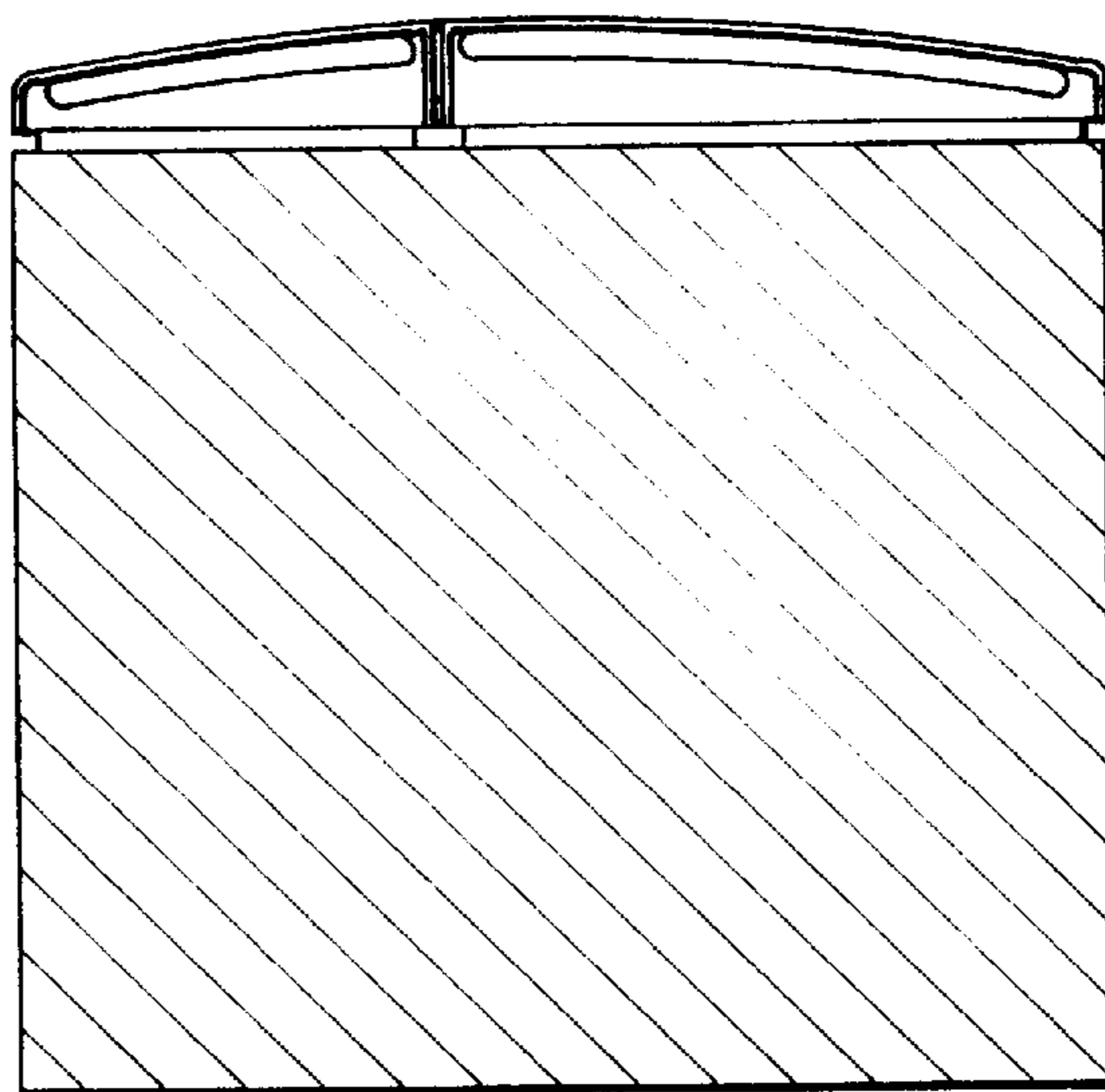

FIG. 11

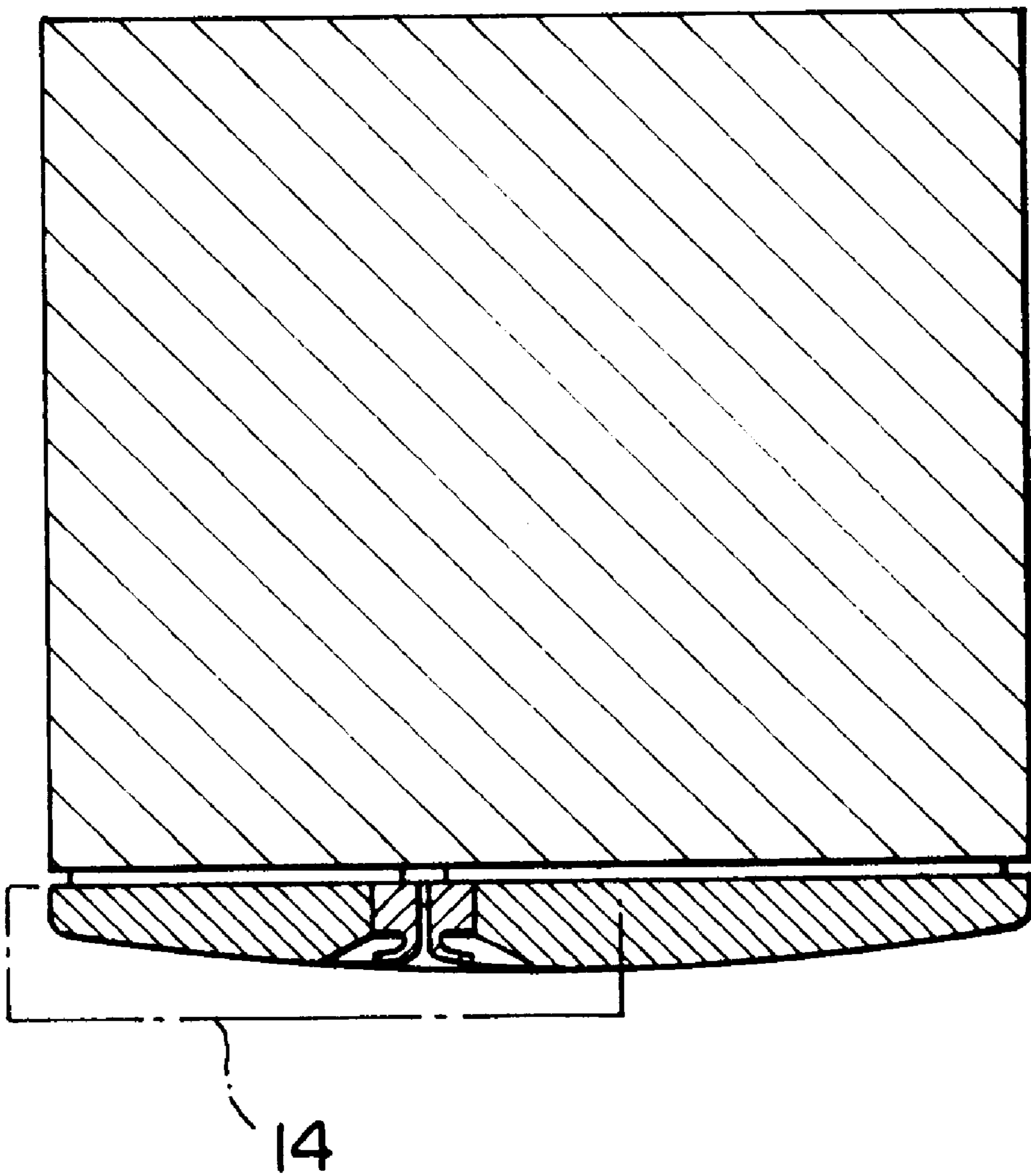

FIG. 12

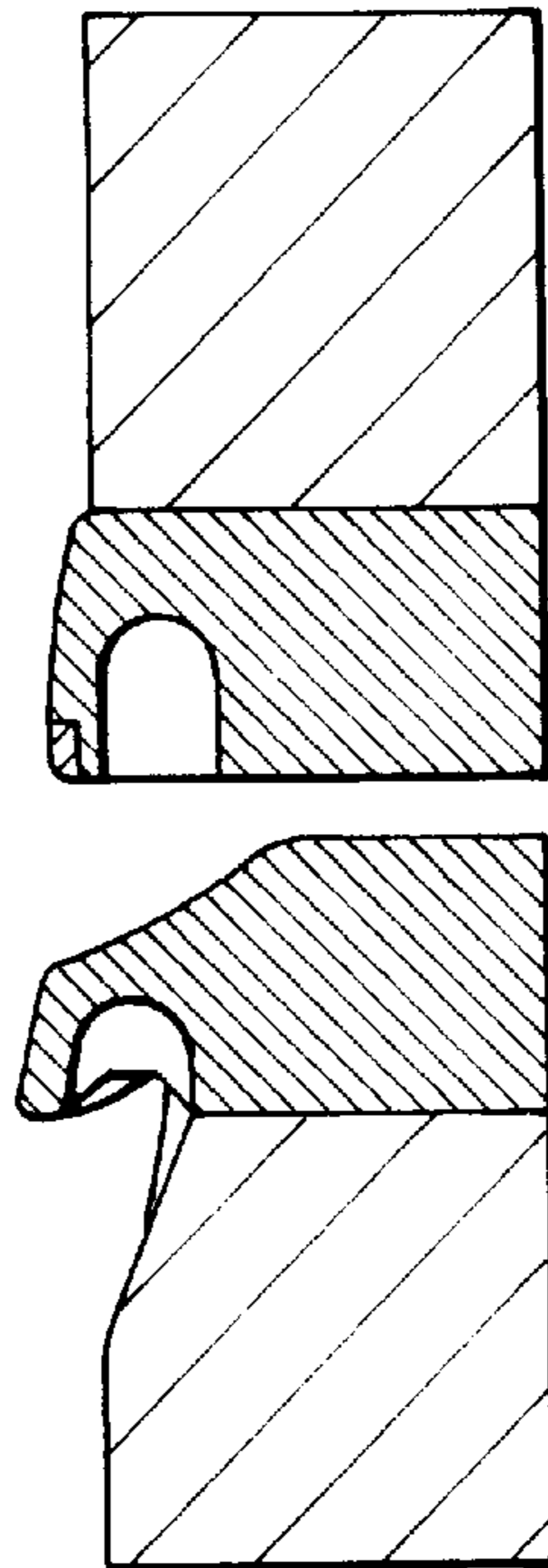

FIG. 13

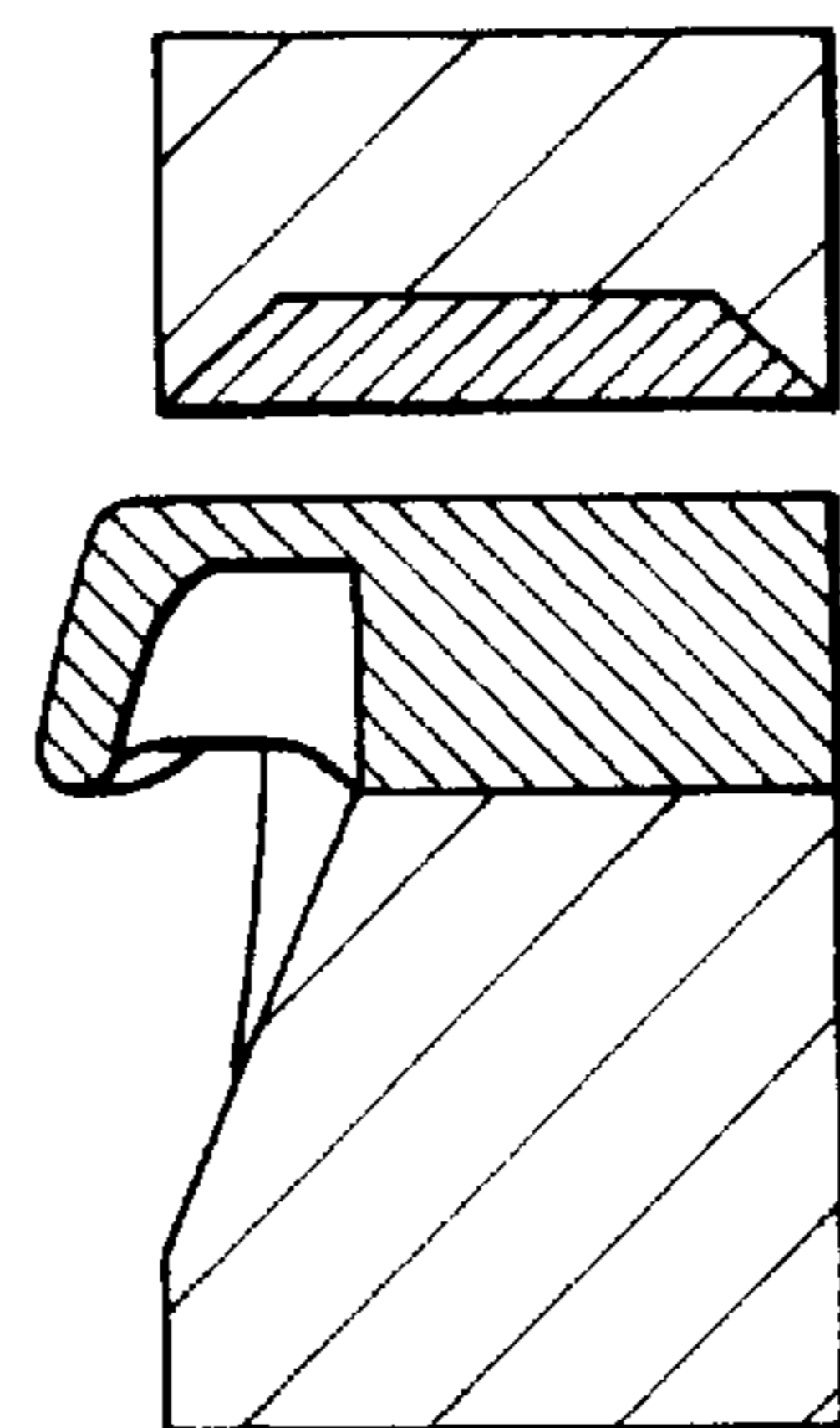

FIG. 14

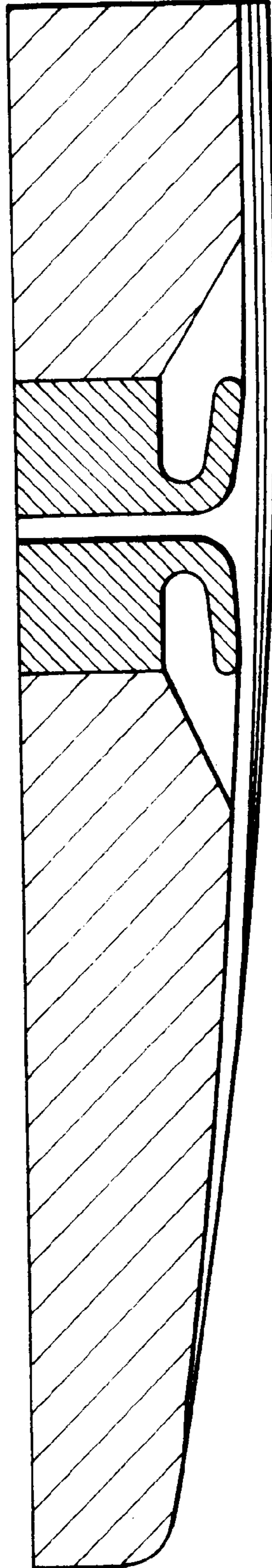

FIG. 15

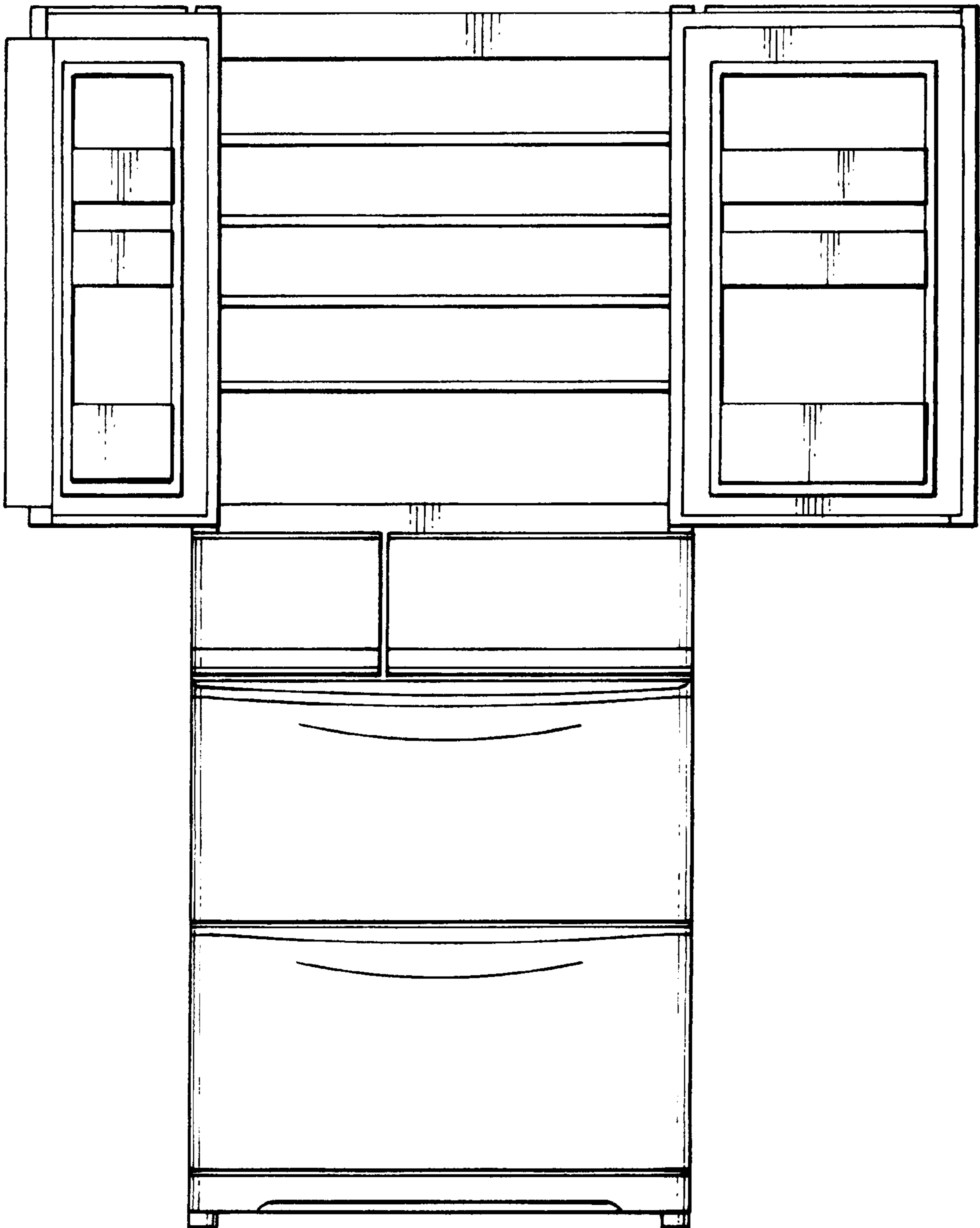

FIG. 16

