



US00D41000S

United States Patent [19]

[11] Patent Number: **Des. 410,000**

Nuovo

[45] Date of Patent: **** May 18, 1999**

[54] **HANDSET**

[75] Inventor: **Frank Nuovo**, Los Angeles, Calif.

[73] Assignee: **Nokia Mobile Phones Limited**, Espoo, Finland

[**] Term: **14 Years**

[21] Appl. No.: **29/084,293**

[22] Filed: **Feb. 27, 1998**

[51] **LOC (6) Cl.** **14-03**

[52] **U.S. Cl.** **D14/138**

[58] **Field of Search** D14/137, 138, D14/147-148, 247-248, 250, 240, 140-142; 379/433, 434, 419, 420, 428, 440; 455/550-575, 90

[56] **References Cited**

U.S. PATENT DOCUMENTS

D. 289,896	5/1987	Martensson et al.	D14/53
D. 299,719	2/1989	Martensson et al.	D14/138
D. 302,423	7/1989	Martensson et al.	D14/138
D. 320,984	10/1991	Tattari	D14/138
D. 325,576	4/1992	Pitkonen	D14/138
D. 325,577	4/1992	Karlin	D14/138
D. 327,059	6/1992	Chu et al.	D14/147 X
D. 334,926	4/1993	Hunt et al.	D14/138
D. 339,338	9/1993	Tattari et al.	D14/138
D. 341,138	11/1993	Cummings	D14/138
D. 345,734	4/1994	Seymour et al.	D14/138
D. 349,112	7/1994	Tattari	D14/138
D. 352,708	11/1994	Rossi	D14/138
D. 353,807	12/1994	White	D14/138
D. 353,809	12/1994	Nuovo et al.	D14/138
D. 354,284	1/1995	White	D14/138
D. 356,561	3/1995	Berry	D14/138
D. 356,562	3/1995	Nuovo	D14/138
D. 356,563	3/1995	Berry	D14/138
D. 359,283	6/1995	Rudkiewicz	D14/149
D. 361,328	8/1995	White	D14/138
D. 361,762	8/1995	Berry	D14/138
D. 364,620	11/1995	Prior et al.	D14/147
D. 374,006	9/1996	Tattari	D14/138
D. 374,007	9/1996	Tattari	D14/138

D. 374,872	10/1996	Scianna, Sr. et al.	D14/138
D. 383,129	9/1997	Giordano et al.	D14/138
D. 384,950	10/1997	Park	D14/138
D. 385,554	10/1997	Nuovo et al.	D14/138
D. 385,876	11/1997	Park	D14/138
D. 385,887	11/1997	Park	D14/250
D. 386,188	11/1997	Park	D14/250
D. 386,493	11/1997	Mahan	D14/138
D. 388,784	1/1998	Phillips et al.	D14/138
D. 390,555	2/1998	Finke-Anlauff	D14/138
D. 392,283	3/1998	Giordano et al.	D14/138
D. 395,299	9/1998	Yamazaki et al.	D14/138
5,151,946	9/1992	Martensson	379/433 X

OTHER PUBLICATIONS

Page showing Nokia 8110i telephone, Jun. 1997.
Page showing Mitsubishi Mt-11 and MT-20 D telephones, Jun. 1997.

Primary Examiner—Jeffrey Asch
Attorney, Agent, or Firm—Perman & Green, LLP

[57] **CLAIM**

The ornamental design for a “handset”, as shown and described.

DESCRIPTION

FIG. 1 is a bottom plan view of a handset, showing my new design with its sliding lid in a closed position; FIG. 2 is a right side elevational view thereof; FIG. 3 is a front elevational view thereof; FIG. 4 is a left side elevational view thereof; FIG. 5 is a top plan view thereof; FIG. 6 is a rear elevational view thereof; FIG. 7 is a top, front and left side perspective view thereof; FIG. 8 is a bottom, rear and left side perspective view thereof; FIG. 9 is a front elevational view thereof, with the sliding lid in an opened position; FIG. 10 is a top, front and right side perspective view thereof; and, FIG. 11 is a rear, bottom and right side perspective view thereof.

1 Claim, 5 Drawing Sheets

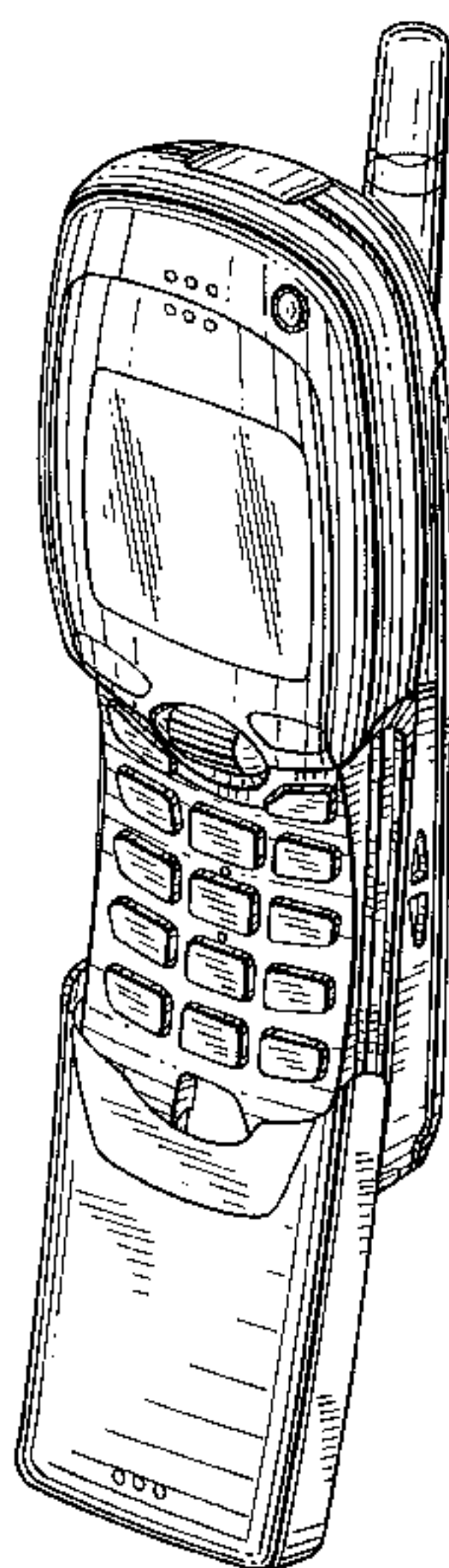

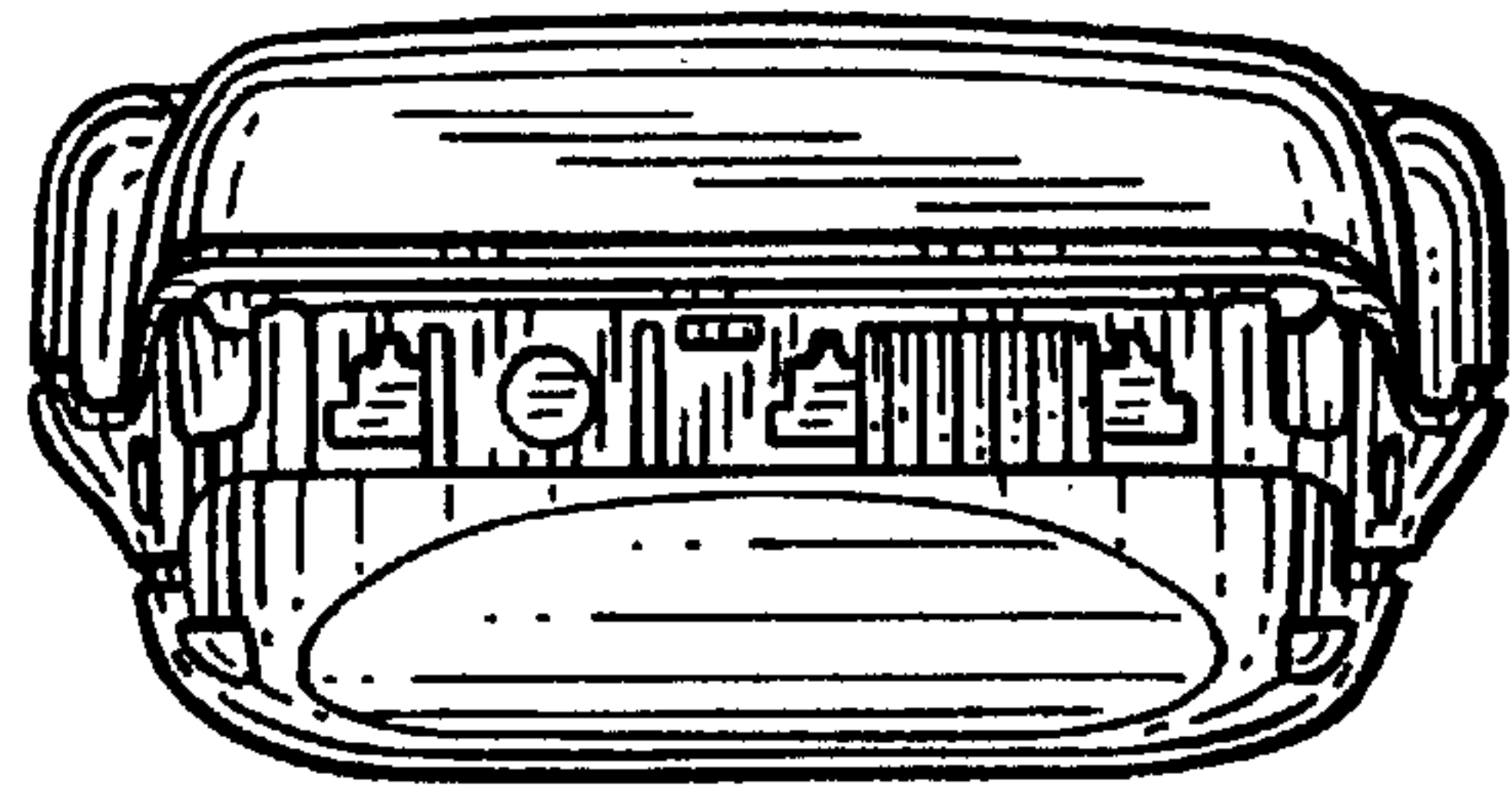

FIG. 1

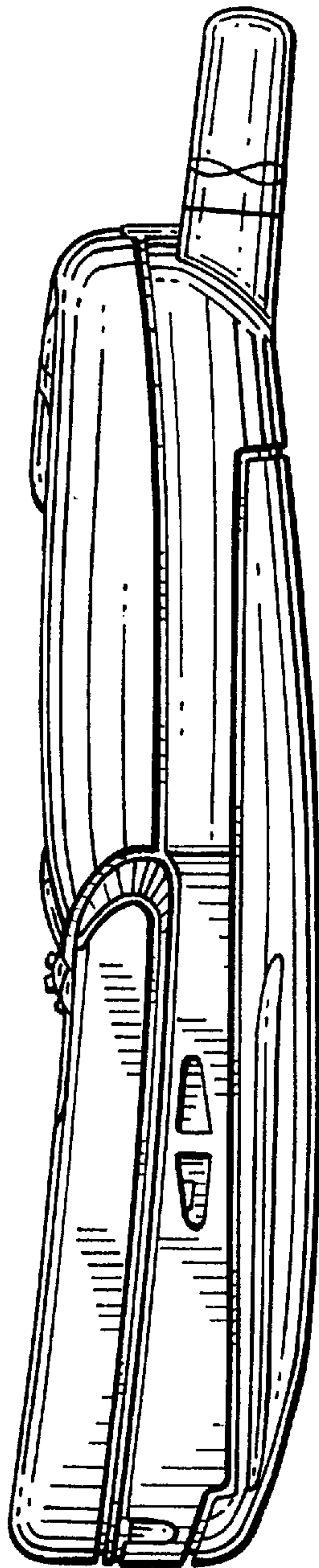

FIG. 2

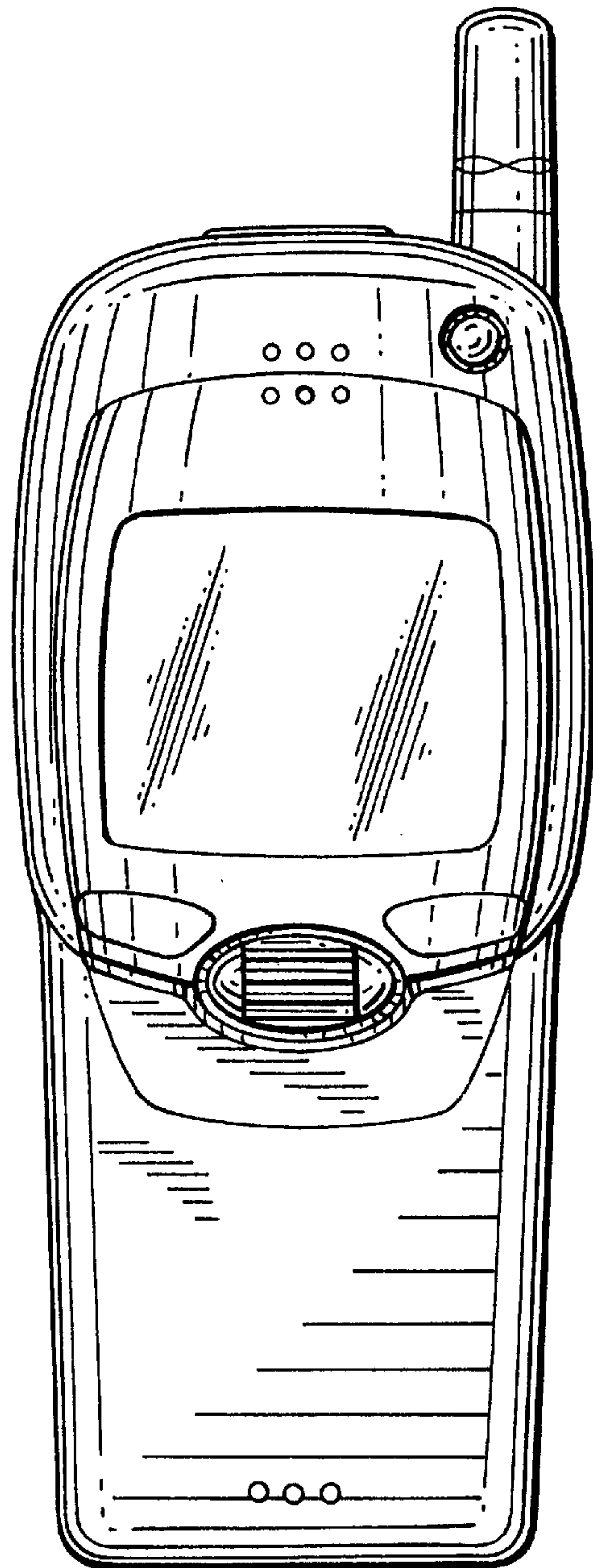

FIG. 3

FIG. 5

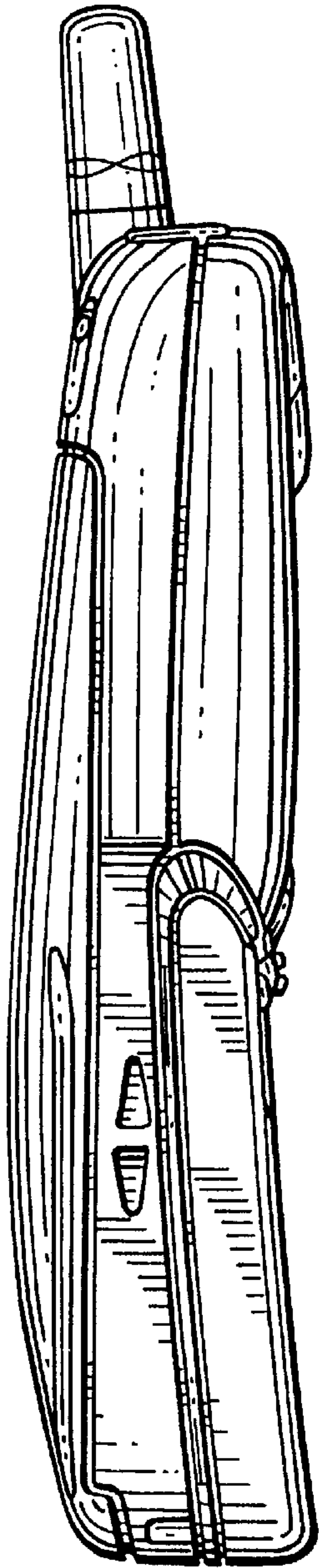
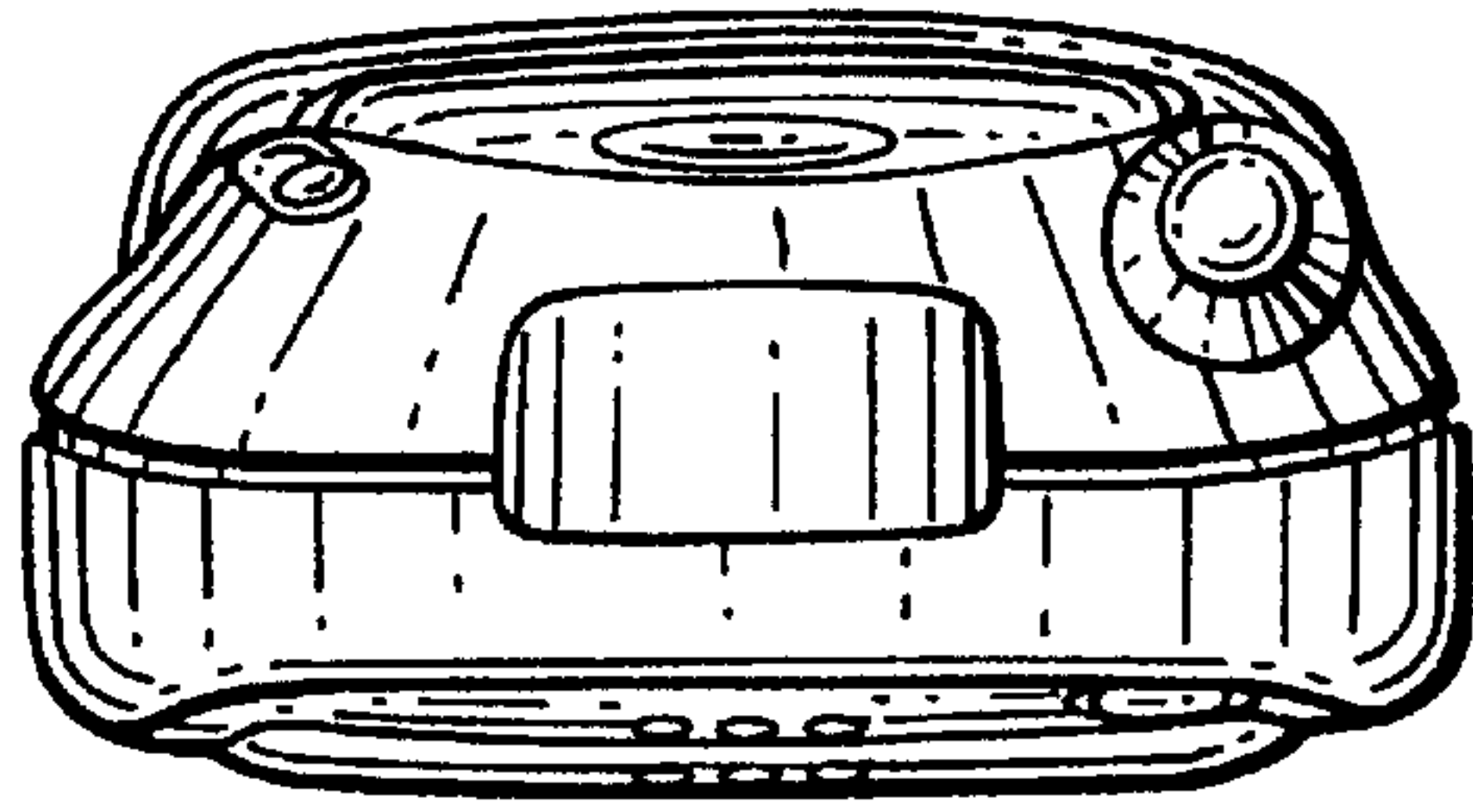

FIG. 4

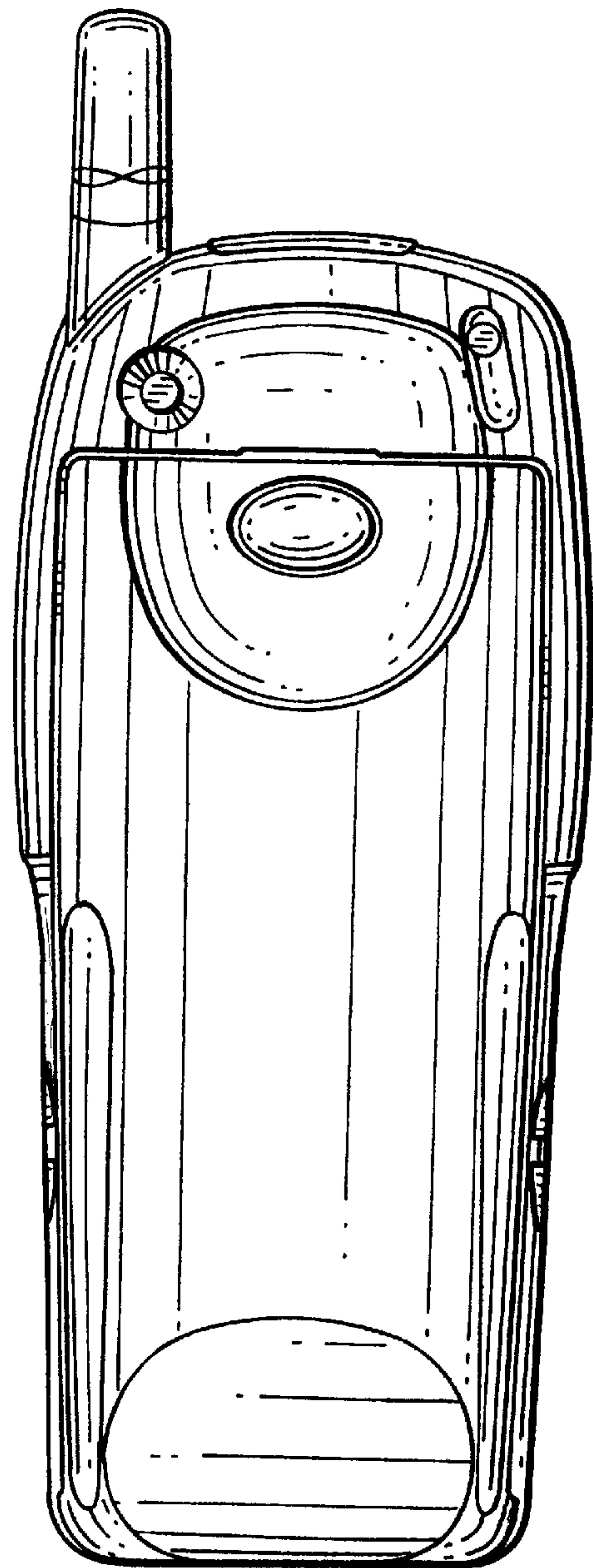

FIG. 6

FIG. 7

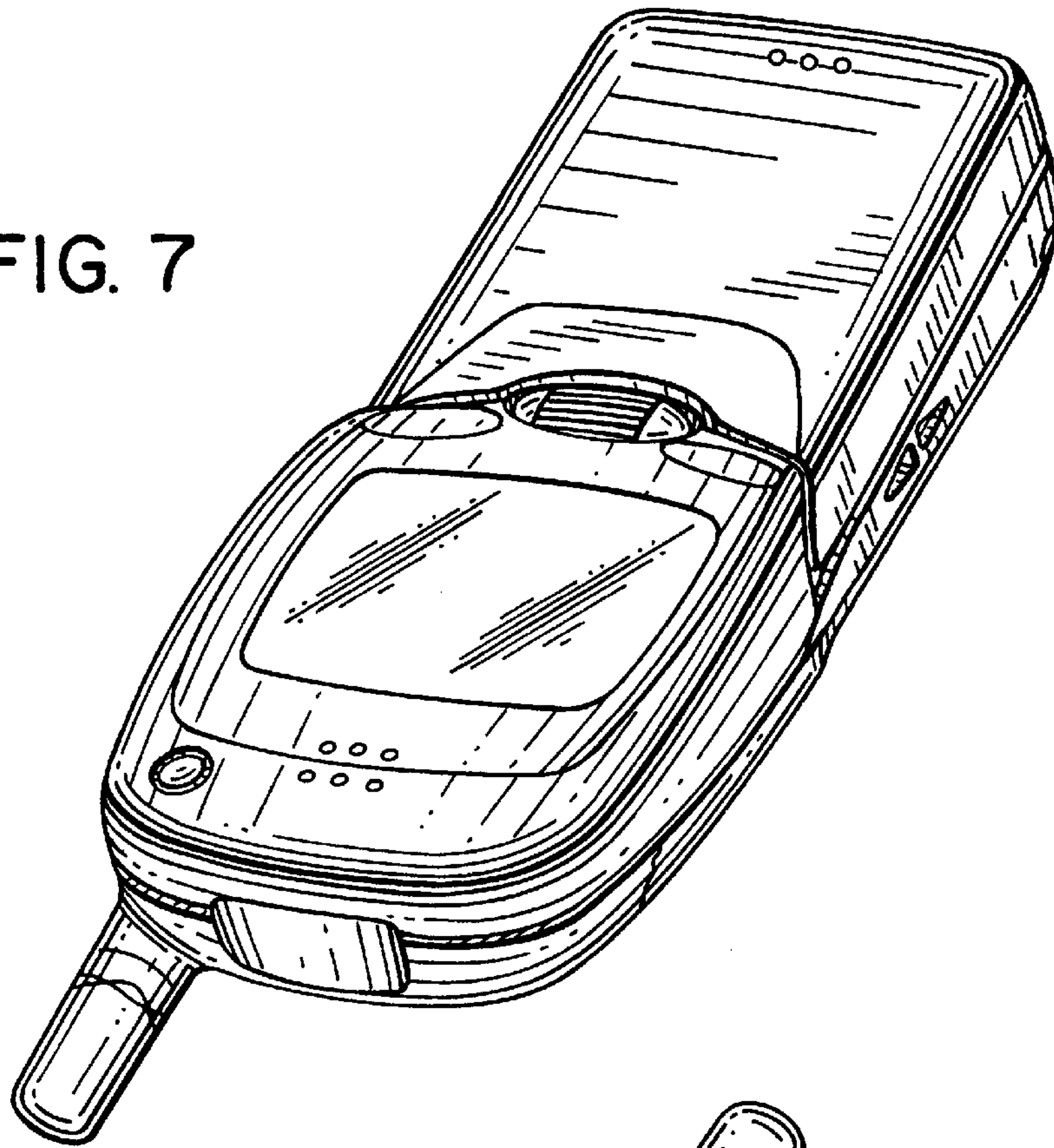
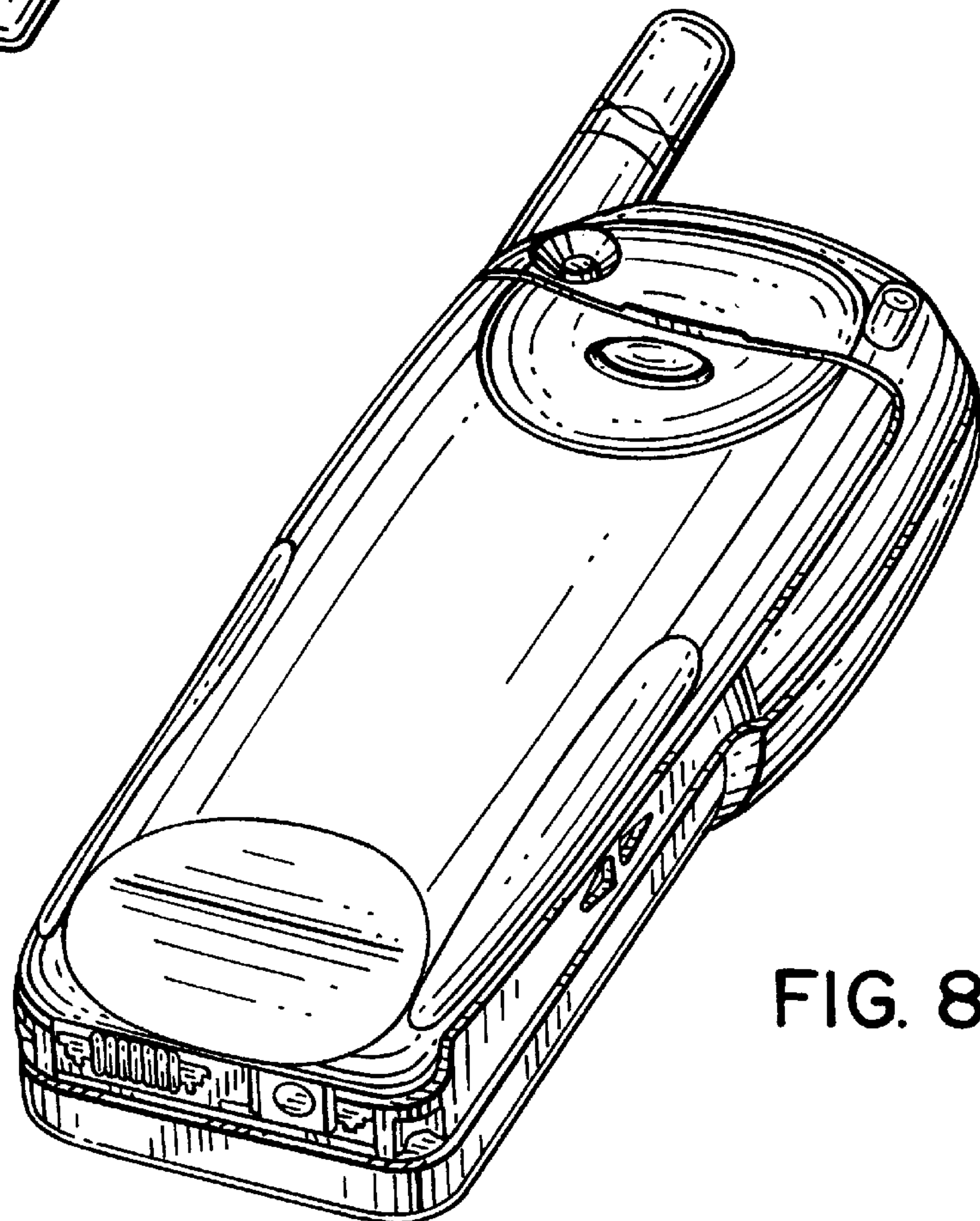

FIG. 8



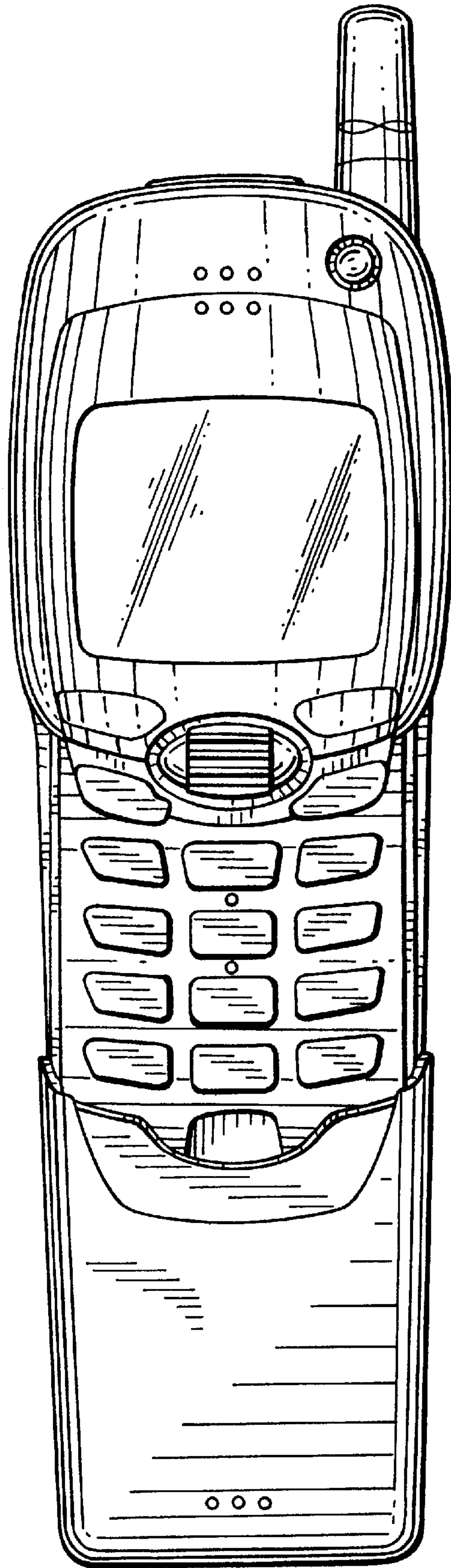

FIG. 9

FIG. 10

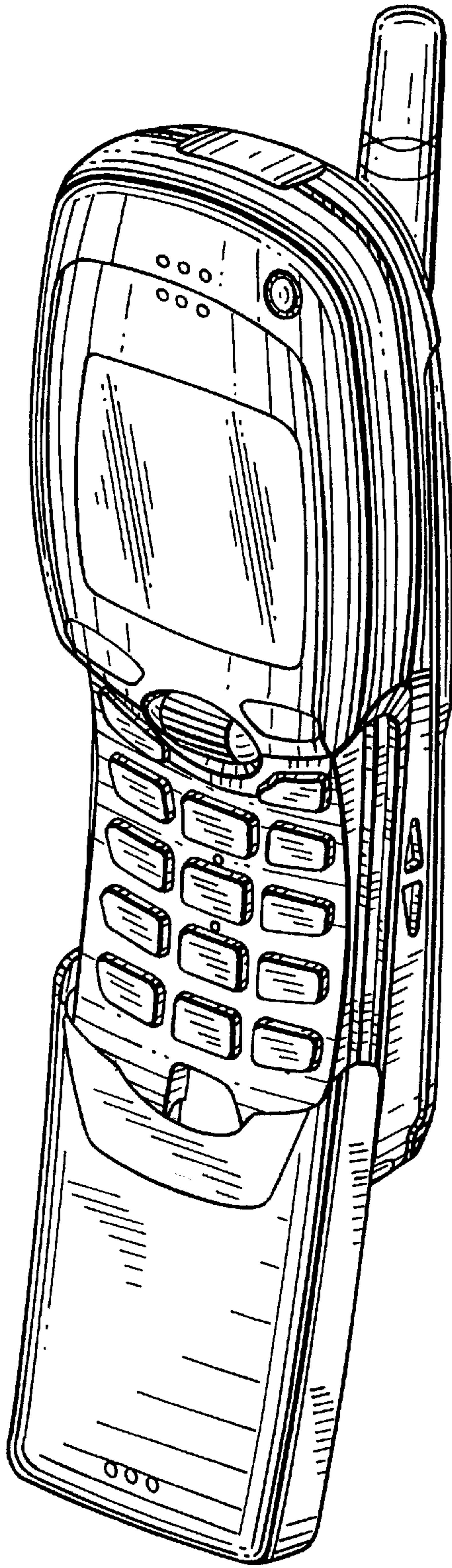

FIG. 11

