



US00D409948S

United States Patent [19]
Almeida

[11] **Patent Number: Des. 409,948**

[45] **Date of Patent: ** May 18, 1999**

[54] **SOIL RETENTION SHIELD FOR POTTED PLANTS**

2,446,948 8/1948 Neutra 47/28.1 X
4,995,192 2/1991 DeWid 47/25 X

[76] Inventor: **Eddie G. Almeida**, R.R. #1, Freelton, Ontario, Canada, LOR 1K0

Primary Examiner—Doris V. Coles
Assistant Examiner—Linda Brooks
Attorney, Agent, or Firm—Patrick J. Hofbauer

[**] Term: **14 Years**

[57] **CLAIM**

[21] Appl. No.: **29/090,831**

The ornamental design for a soil retention shield for potted plants, as shown and described.

[22] Filed: **Jul. 17, 1998**

DESCRIPTION

[51] **LOC (6) Cl.** **11-02**

[52] **U.S. Cl.** **D11/164**

[58] **Field of Search** D11/143–147, D11/152–154, 164; D6/403, 405, 455, 457, 469; 47/23, 25, 26, 27, 28.1, 31, 32; D7/337; 248/27.8; 206/423

FIG. 1 is perspective view of the first variant of the soil retention shield for potted plants showing my new design.

FIG. 2 is top view of FIG. 1.

FIG. 3 is a side view of FIG. 1, the opposite side being a mirror image.

FIG. 4 is bottom top view of FIG. 1.

FIG. 5 is perspective view of the second variant of the soil retention shield for potted plants showing my new design.

FIG. 6 is top view of FIG. 5.

FIG. 7 is a side view of FIG. 5, the opposite side being a mirror image; and,

FIG. 8 is bottom top view of FIG. 5.

[56] **References Cited**

U.S. PATENT DOCUMENTS

D. 241,875	10/1976	Insalaco	D11/164
D. 337,077	7/1993	Turley	D11/164
D. 348,235	6/1994	Spahr	D11/164
915,897	3/1909	Skorness	47/32
1,235,520	7/1917	Kirfman	47/23
1,848,345	3/1932	Gregg	47/28.1

1 Claim, 4 Drawing Sheets

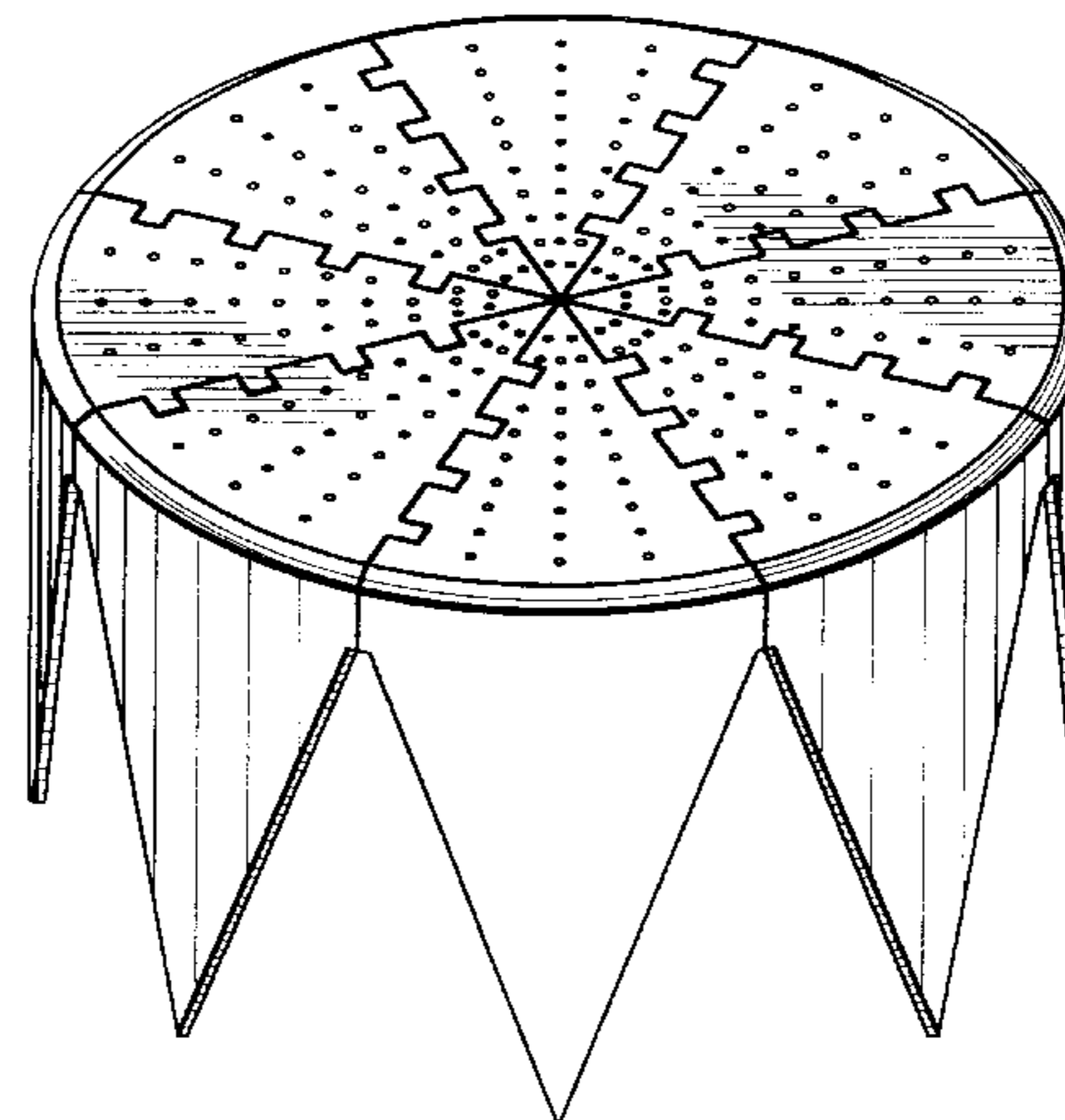
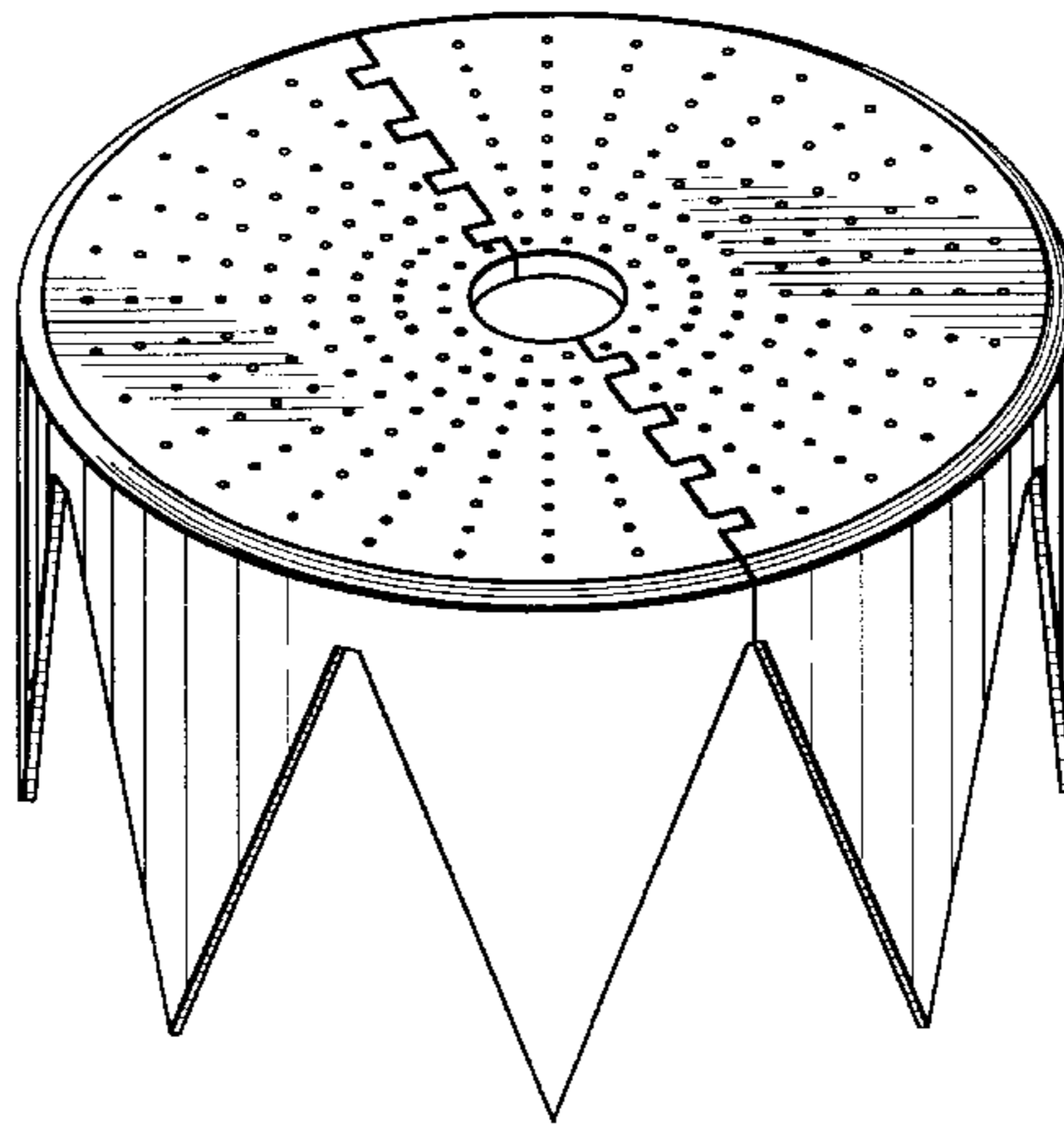

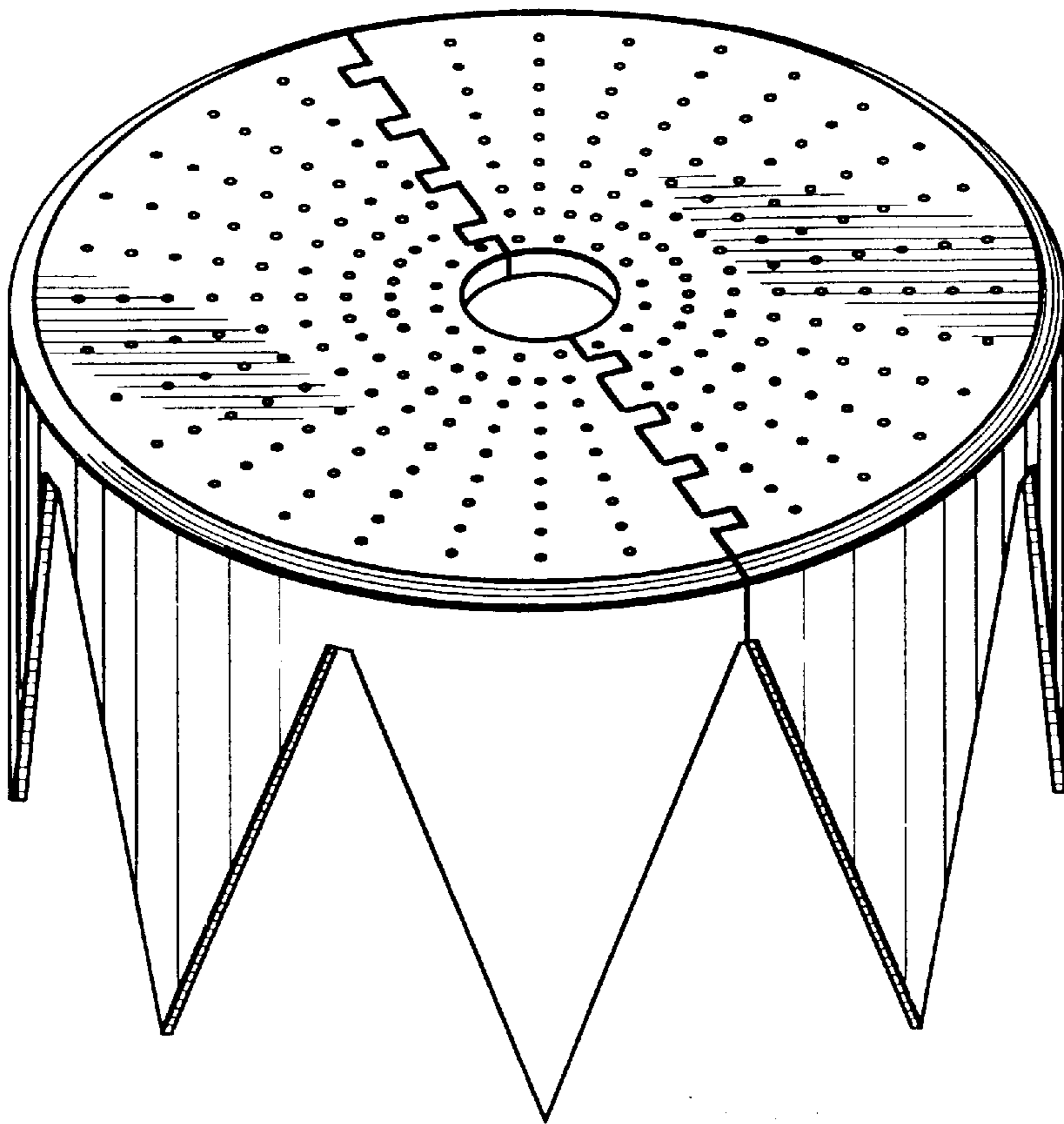

FIG. 1

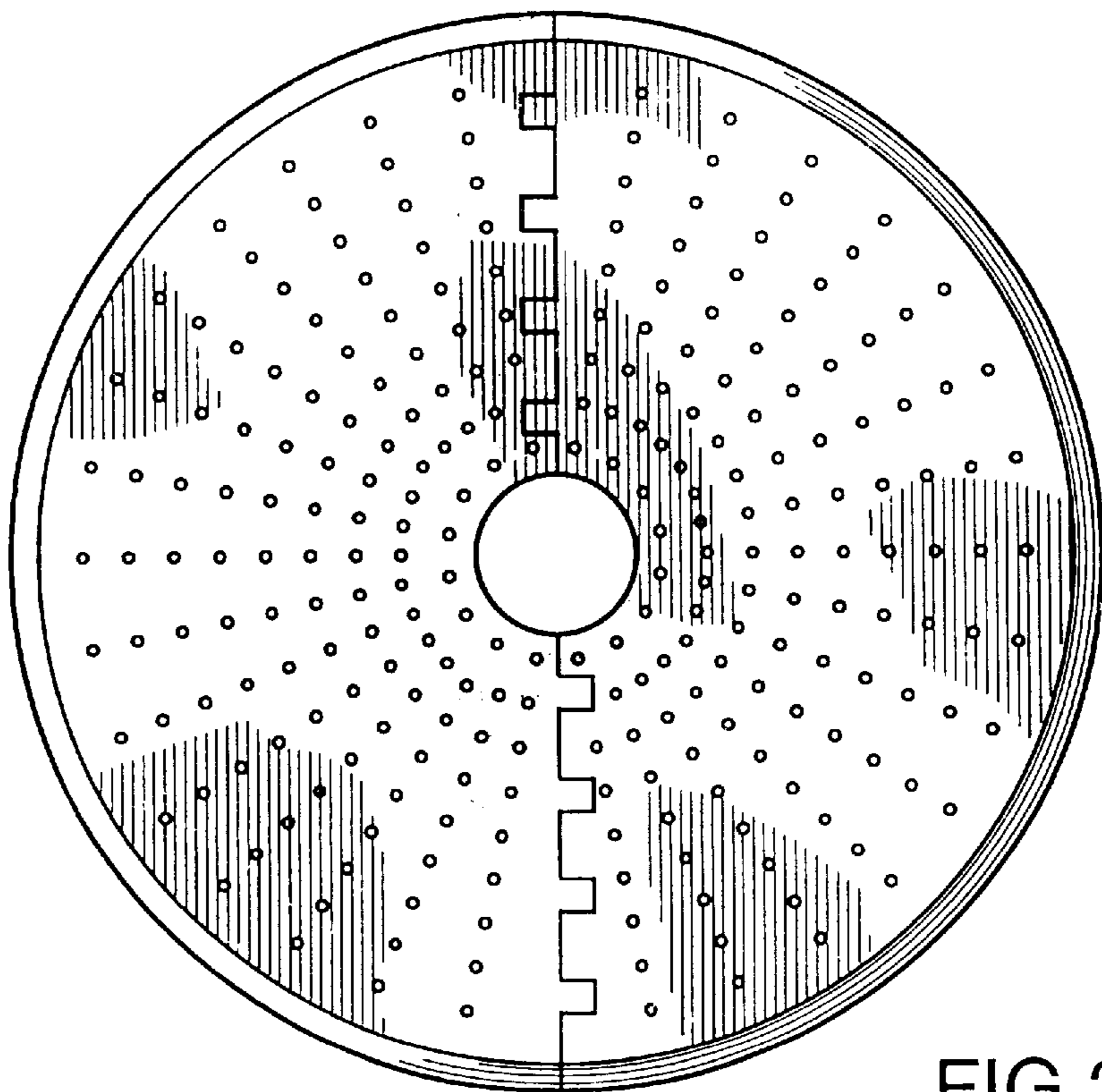

FIG. 2

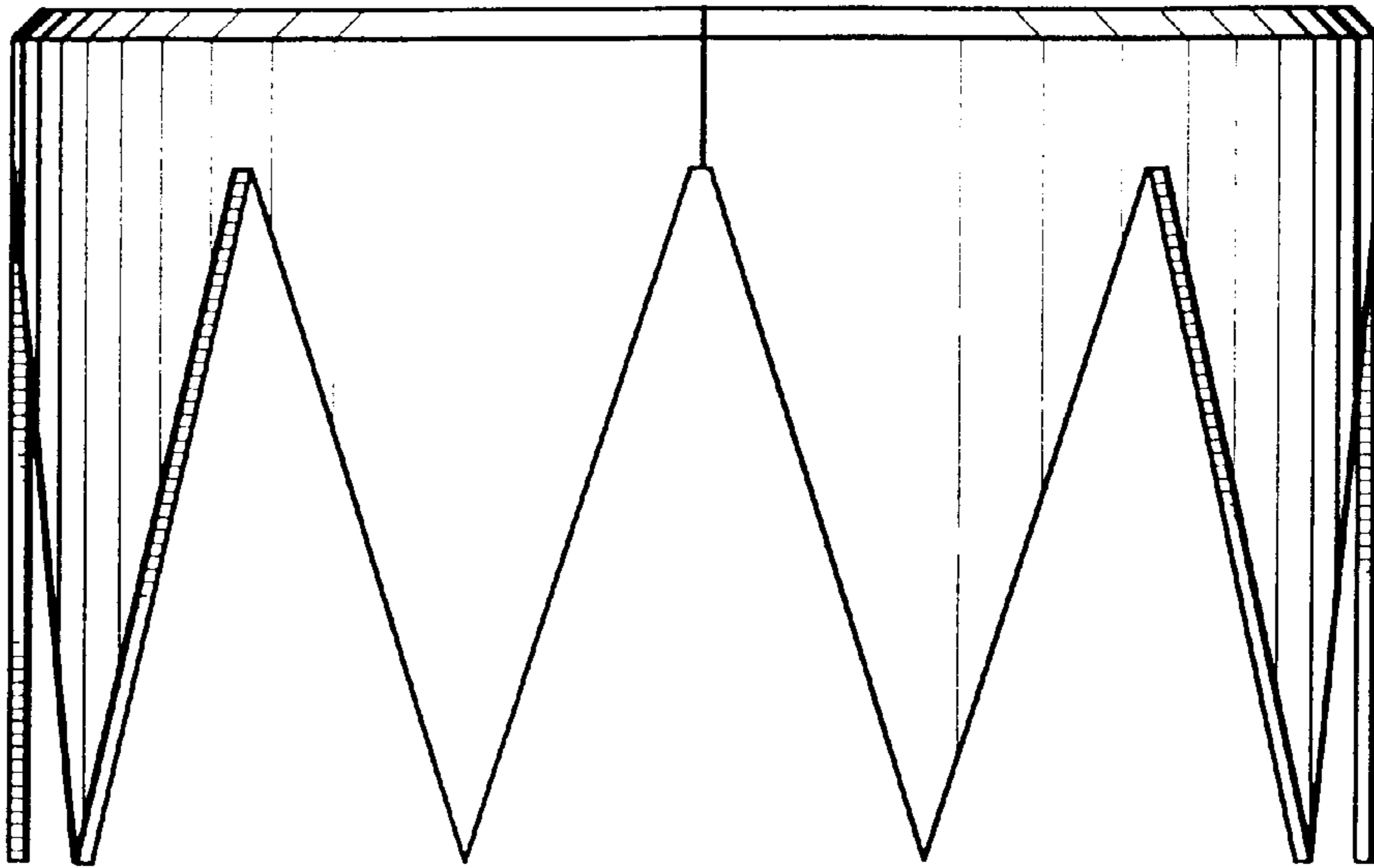

FIG. 3

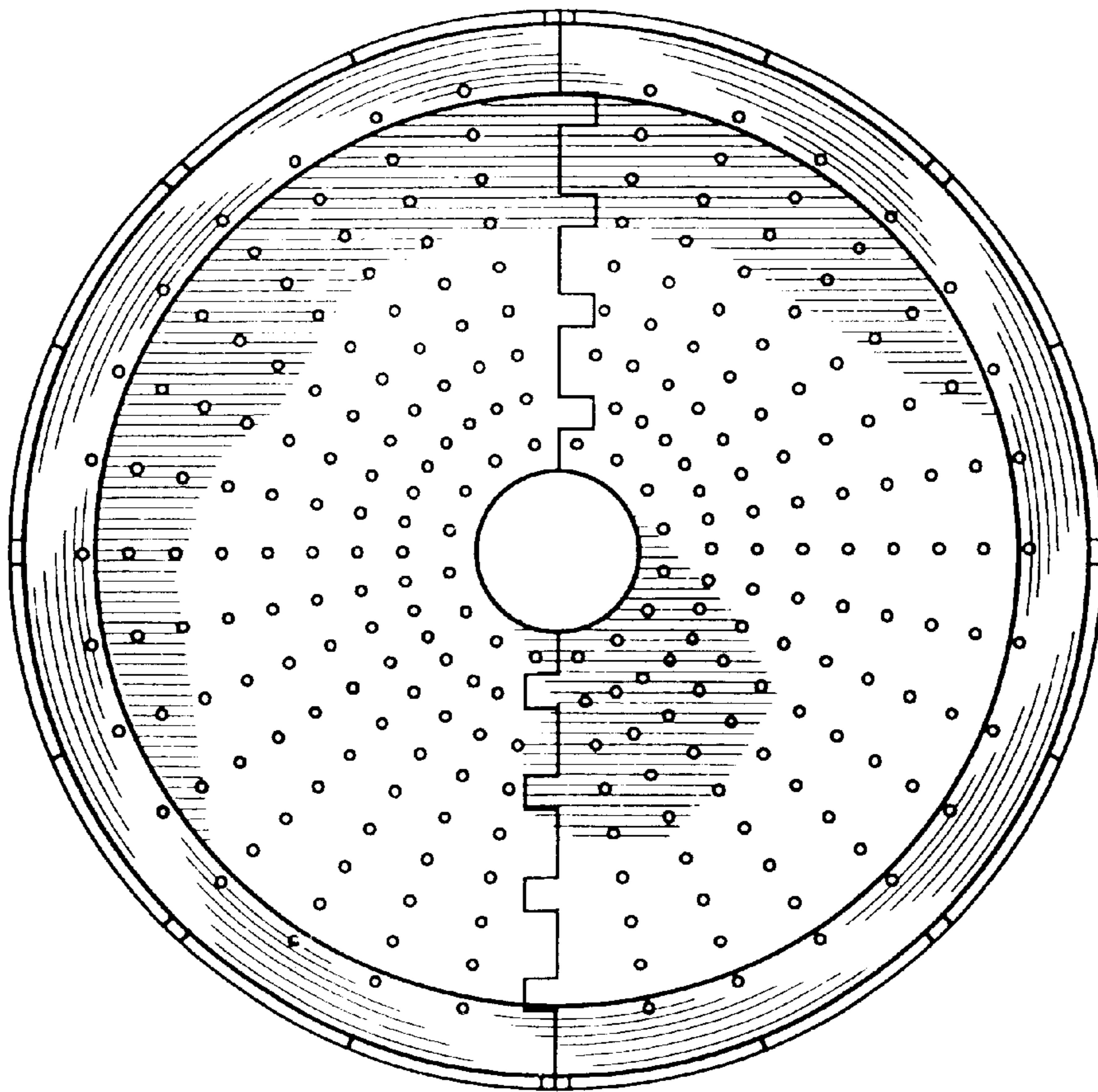

FIG. 4

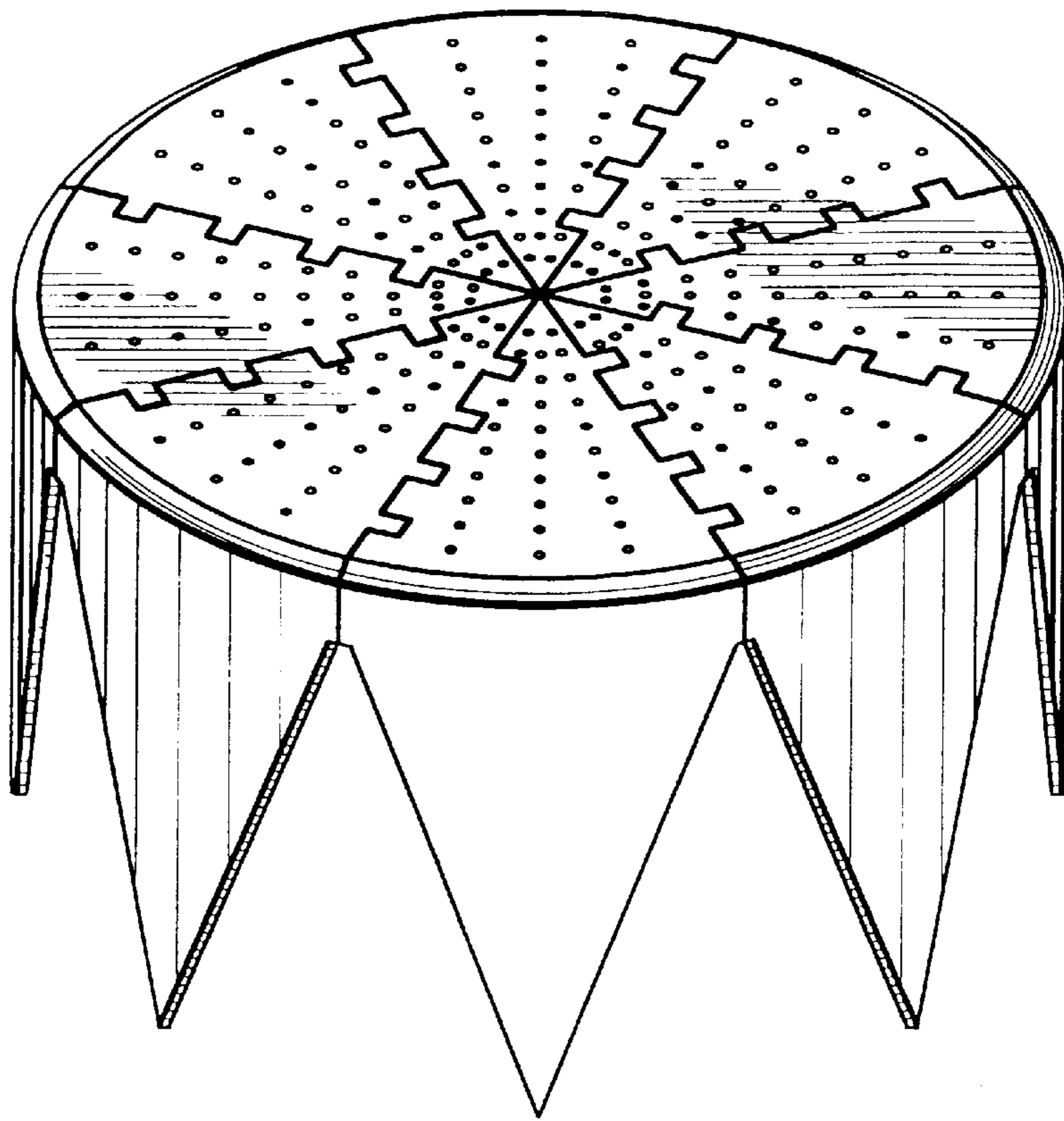

FIG. 5

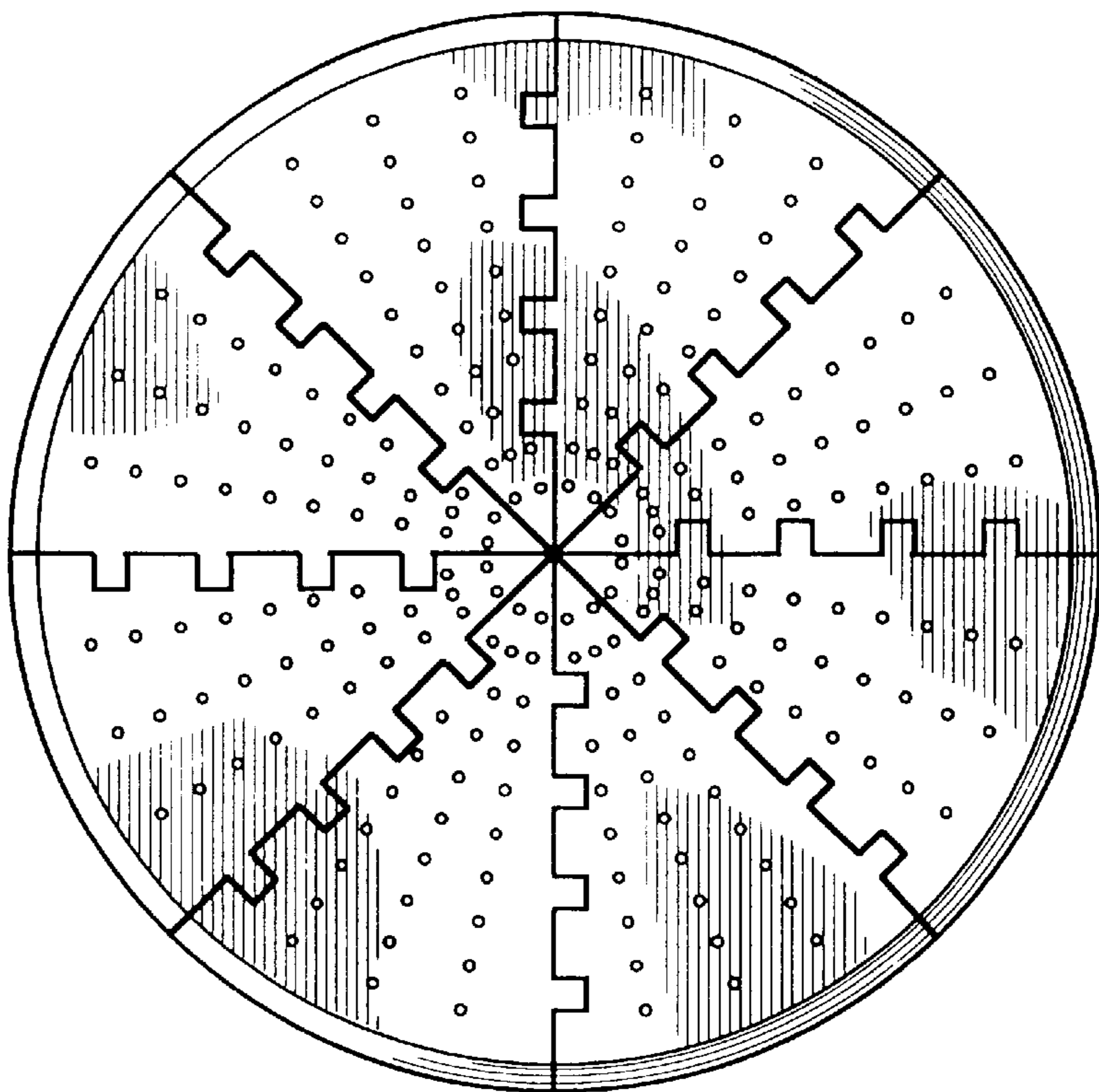

FIG. 6

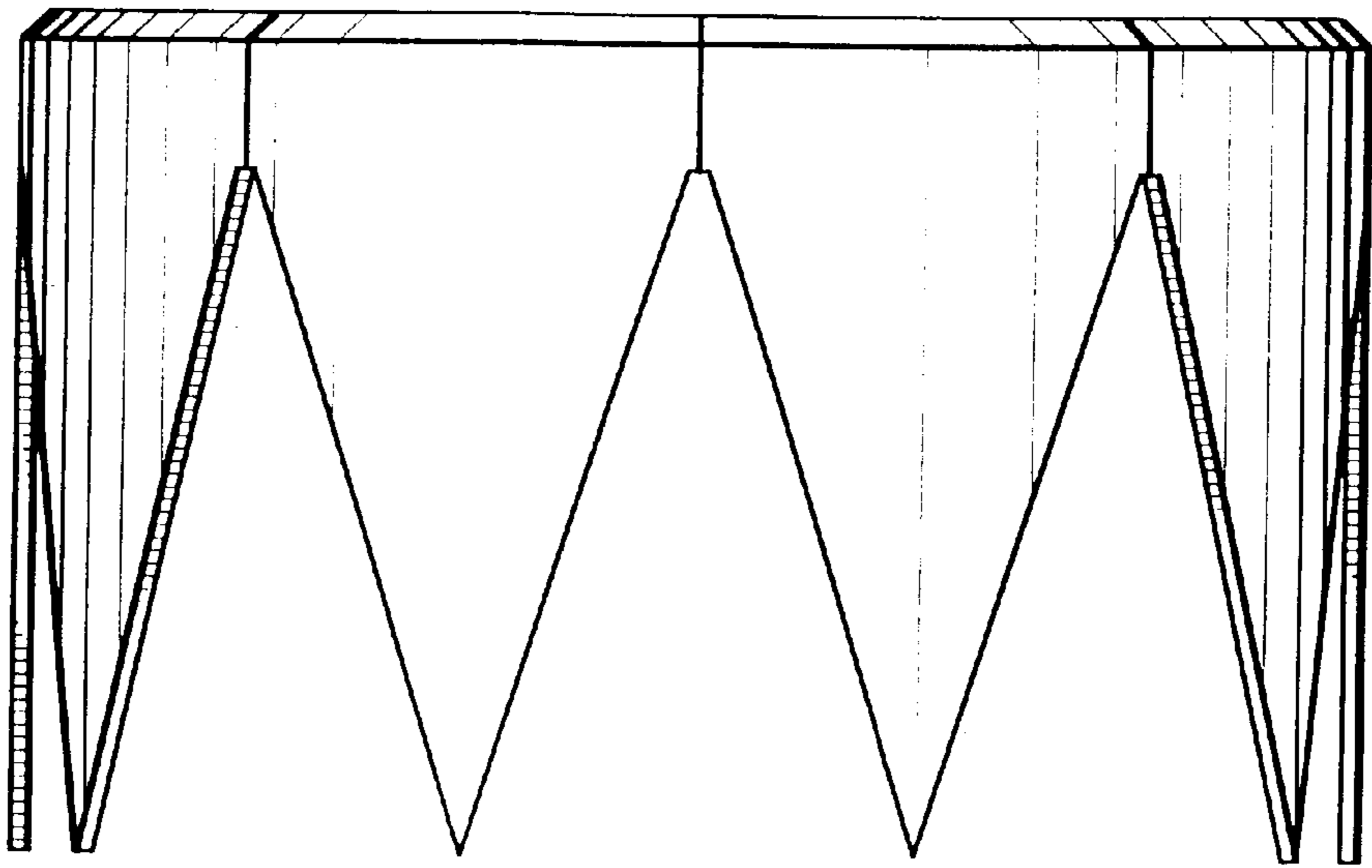

FIG. 7

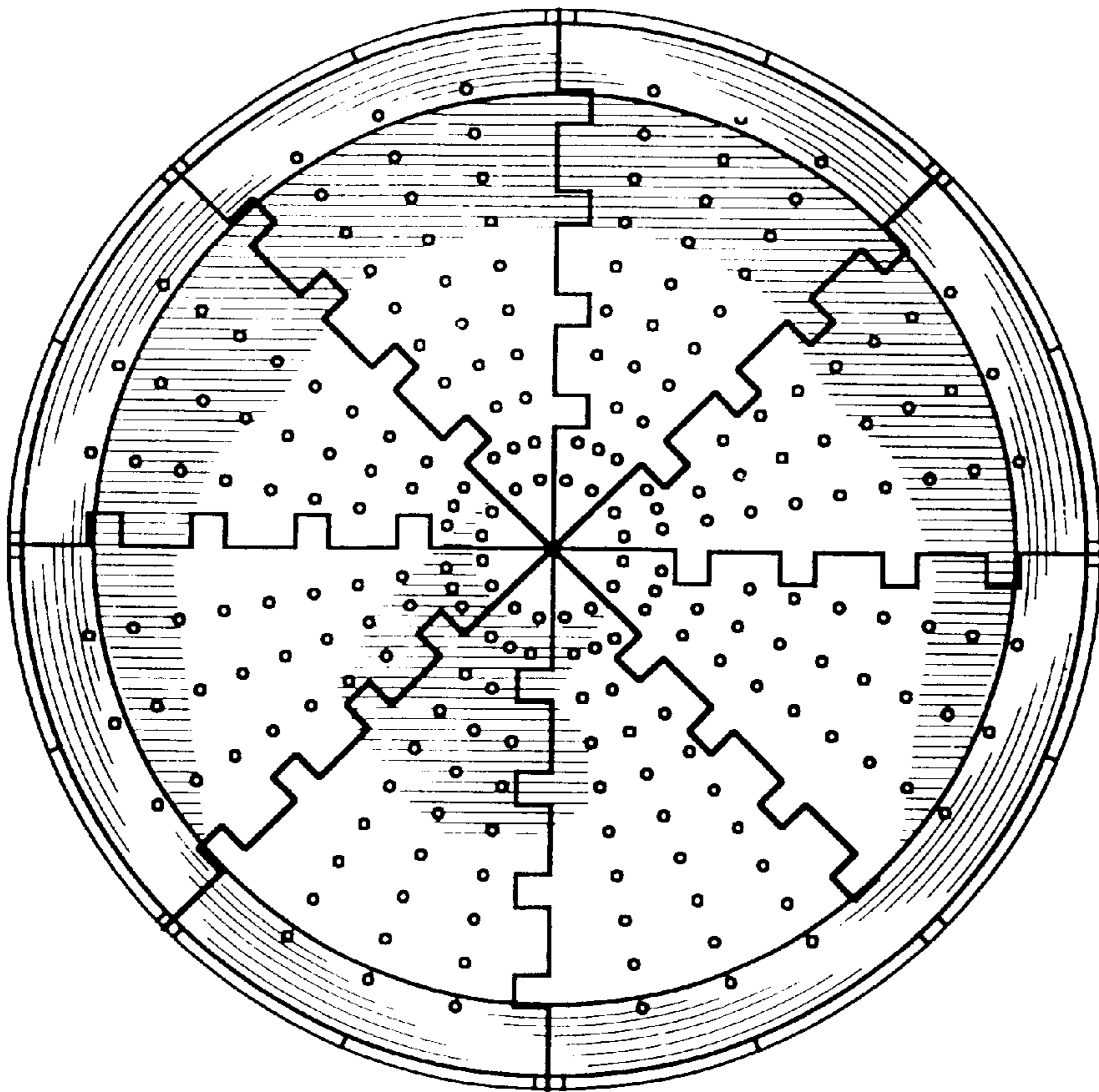

FIG. 8