



US00D409947S

United States Patent [19]

Bongard et al.

[11] Patent Number: **Des. 409,947**

[45] Date of Patent: **** May 18, 1999**

[54] SEED GERMINATION TRAY AND COVER

[75] Inventors: **Mark A. Bongard**, Excelsior; **William A. Boire**, Shorewood, both of Minn.

[73] Assignee: **Emplast, Inc.**, Waconia, Minn.

[**] Term: **14 Years**

[21] Appl. No.: **29/087,975**

[22] Filed: **May 13, 1998**

[51] LOC (6) Cl. **11-02**

[52] U.S. Cl. **D11/155**

[58] Field of Search D11/143-148,
D11/155-156; D30/101; 47/65.5, 65.9,
66.1, 66.5, 67-72, 79, 39, 40; 248/27.8

[56] **References Cited**

U.S. PATENT DOCUMENTS

D. 352,917	11/1994	DesLaurier	D11/155
D. 377,088	12/1996	Vollick	D11/145
D. 381,600	7/1997	Yurkovic	D11/143
2,722,778	11/1955	Carufel .	
3,241,706	3/1966	Monaco et al. .	
3,606,697	9/1971	Eden .	
3,751,852	8/1973	Schrepper .	
3,961,444	6/1976	Skaife .	
4,236,350	12/1980	Hasselbach, Sr. .	

4,249,341	2/1981	Huegli .
4,291,493	9/1981	Monson .
4,291,494	9/1981	Knablein et al. .
5,548,924	8/1996	Mekler .

Primary Examiner—Doris V. Coles
Assistant Examiner—Linda Brooks
Attorney, Agent, or Firm—Nikolai, Mersereau & Dietz, P.A.

[57] **CLAIM**

The ornamental design for a seed germination tray and cover, as shown and described.

DESCRIPTION

FIG. 1 is a perspective view of a seed germination tray and cover made in accordance with the present invention. FIG. 2 is a top plan view of the seed germination tray and cover shown in FIG. 1. FIG. 3 is a bottom plan view of the seed germination tray and cover shown in FIG. 1. FIG. 4 is an elevational view of one side of the seed germination tray and cover shown in FIG. 1, the opposite view side being the mirror image thereof. FIG. 5 is an elevational view of one end of the seed germination tray and cover shown in FIG. 1, the opposite end being the mirror image thereof; and, FIG. 6 is an enlarged cross-sectional view taken along line 6—6 in FIG. 2.

1 Claim, 4 Drawing Sheets

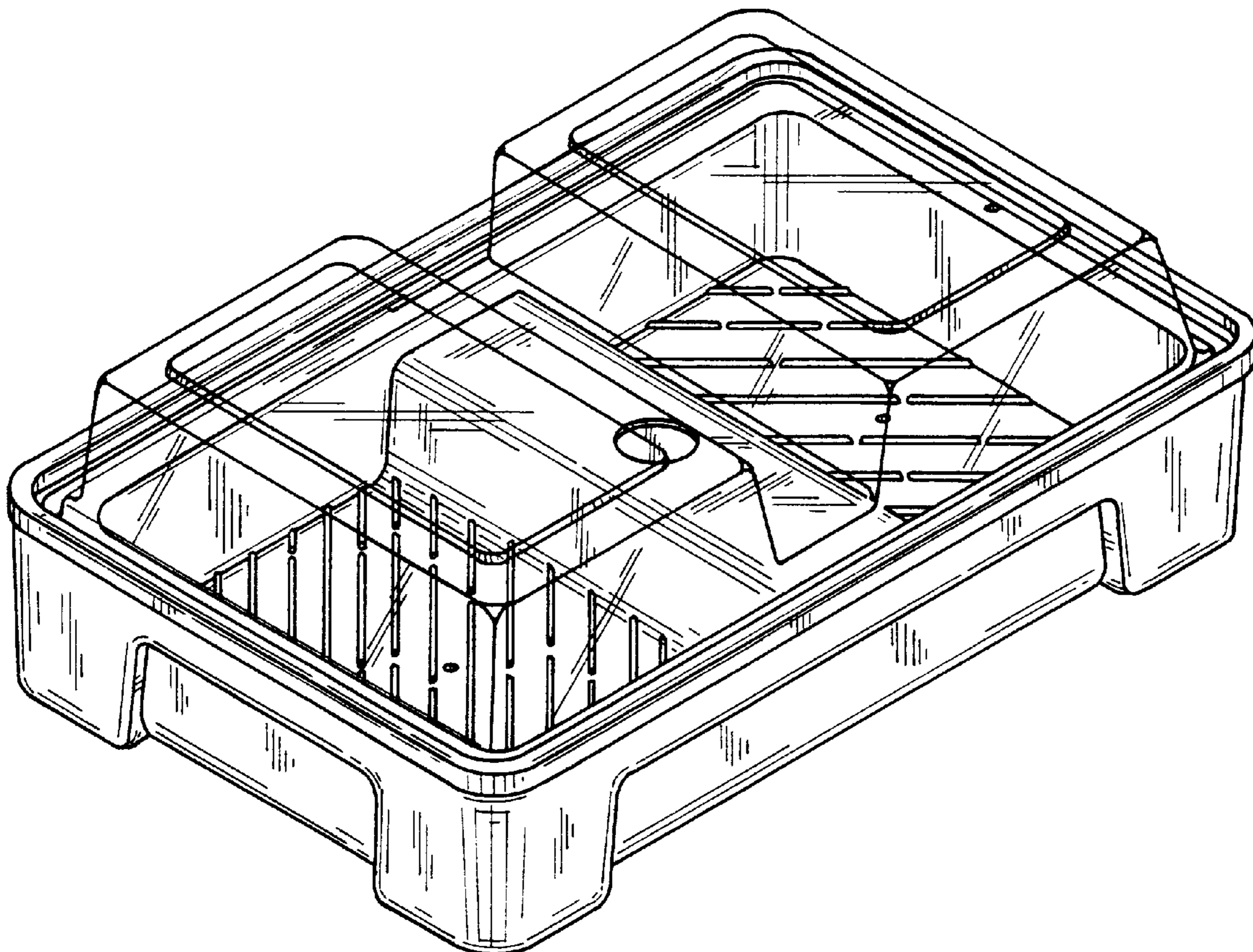

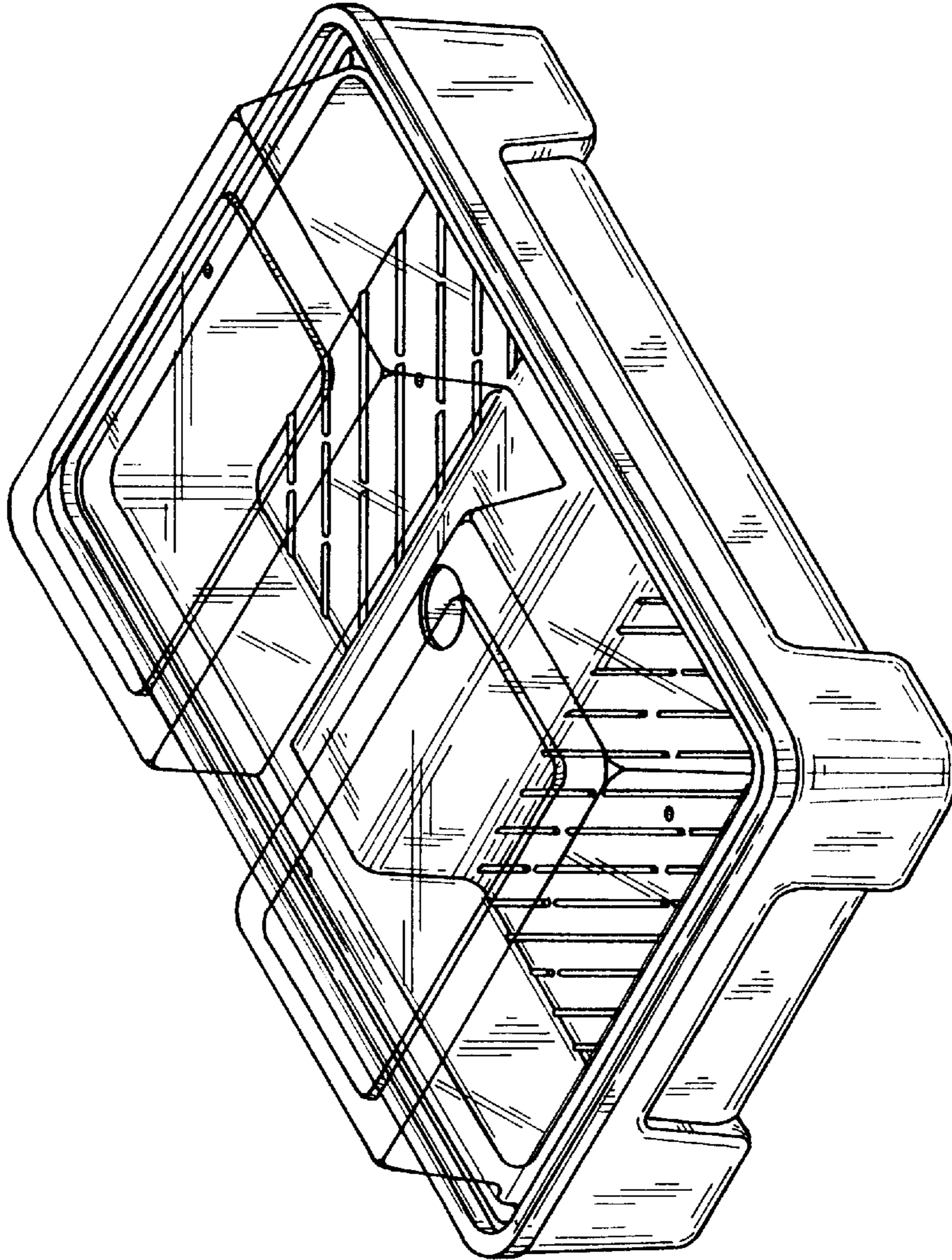

FIG. 1

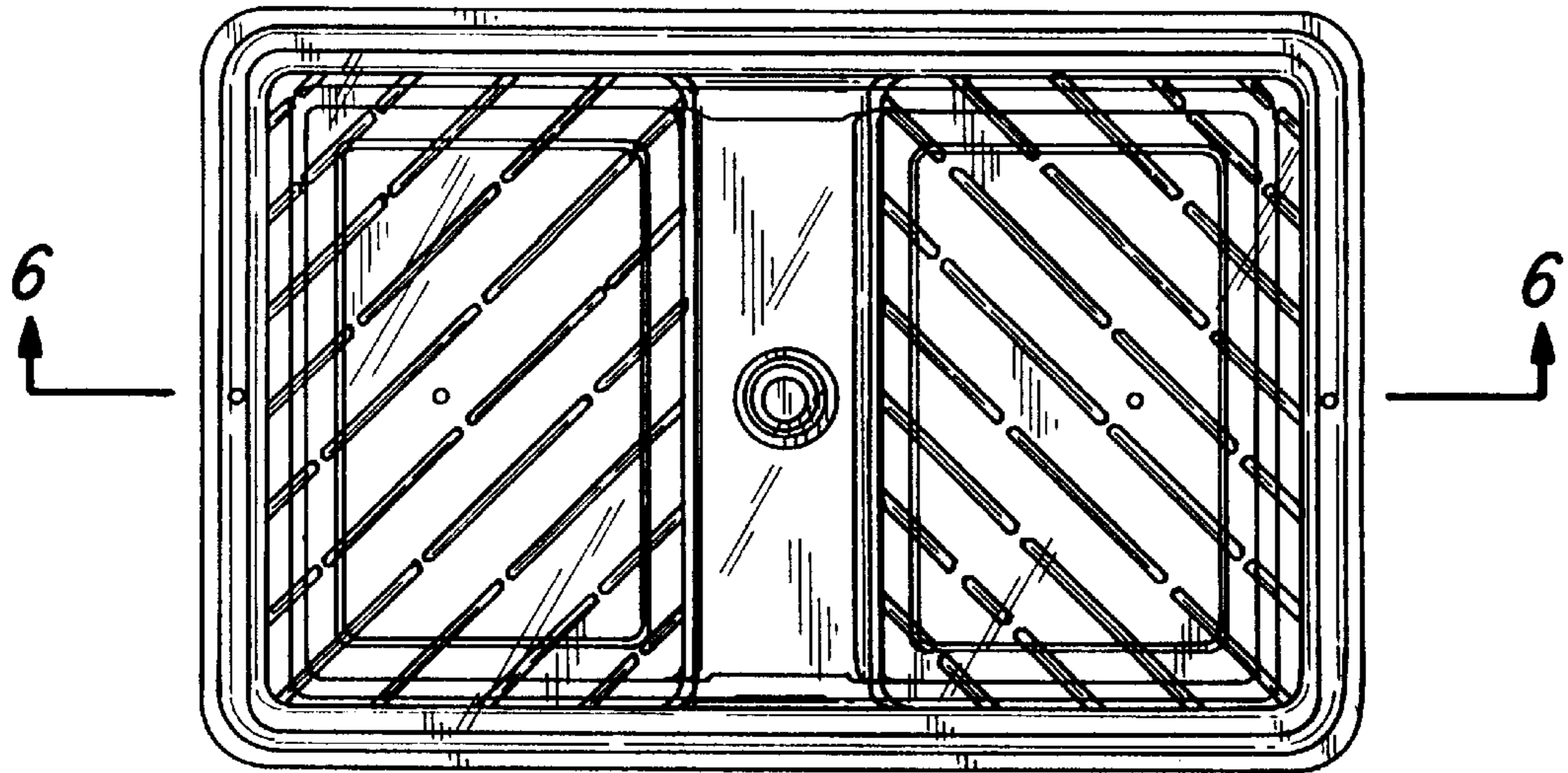

FIG. 2

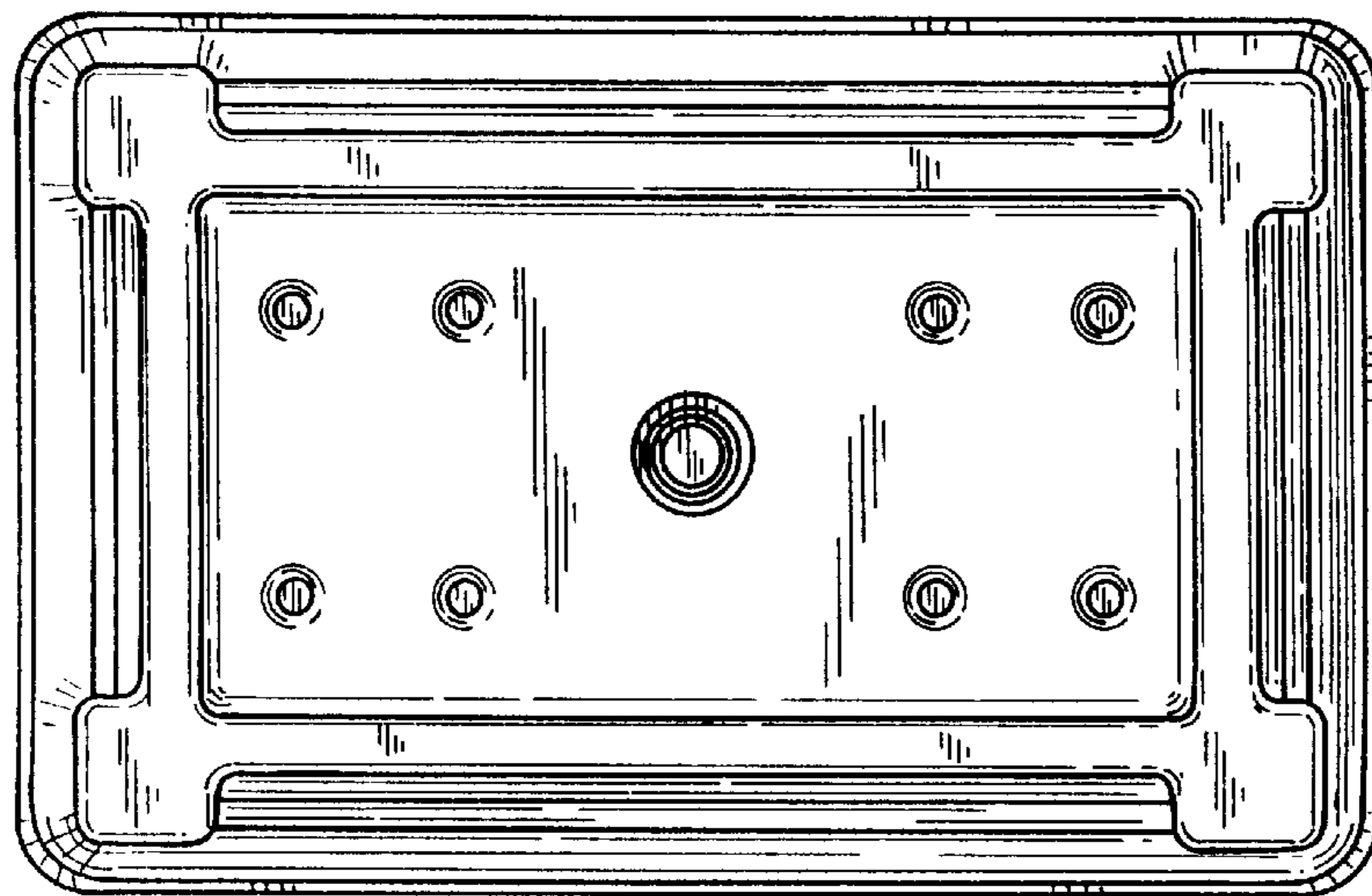

FIG. 3

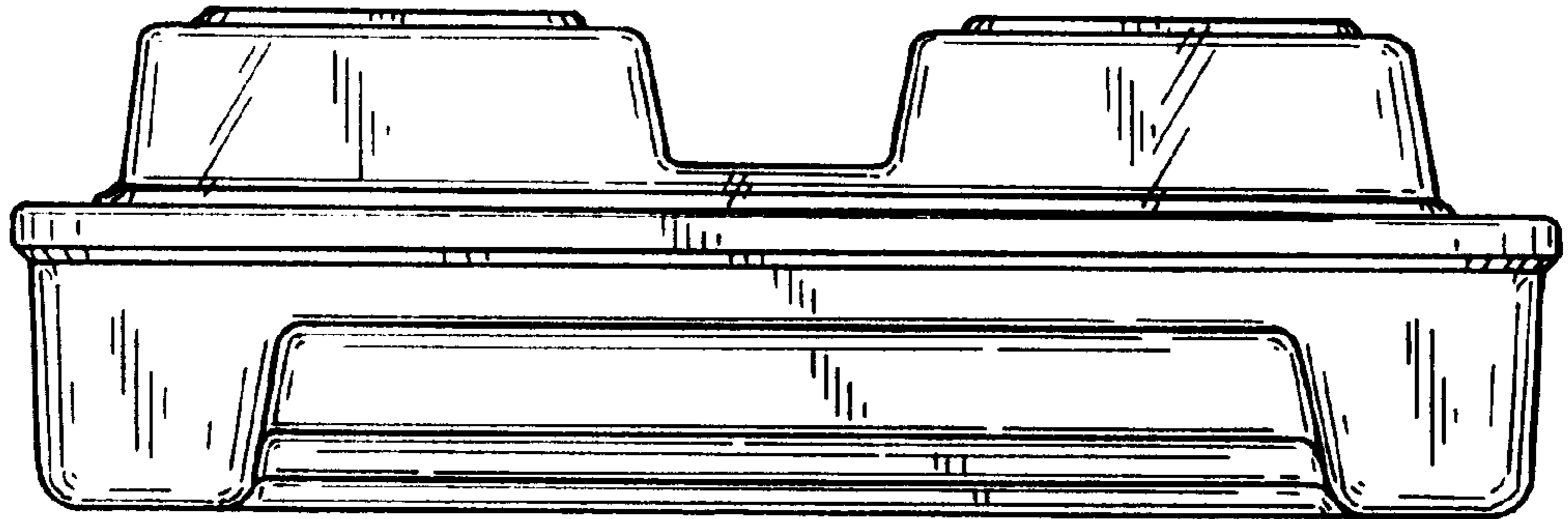

FIG. 4

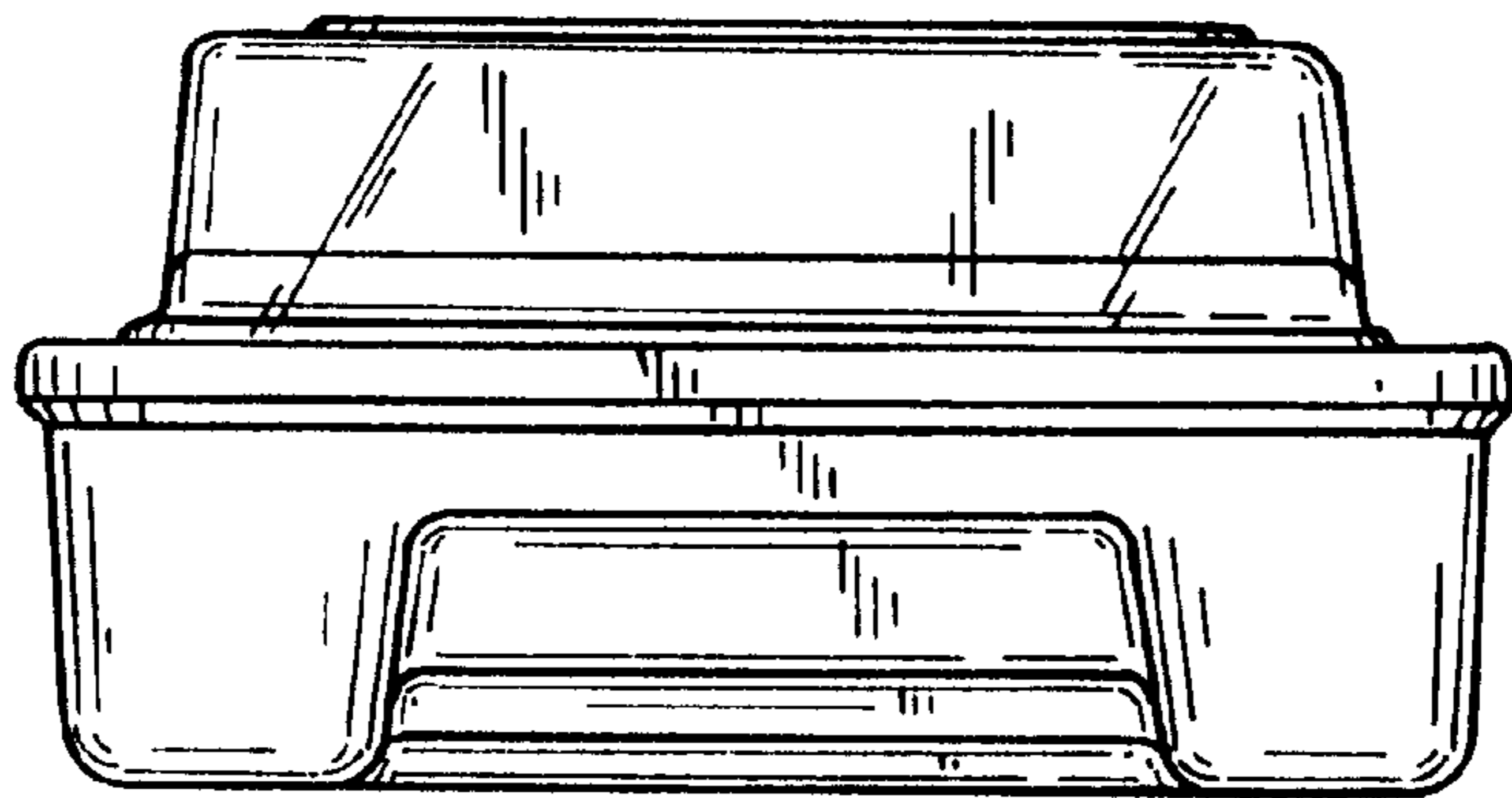

FIG. 5

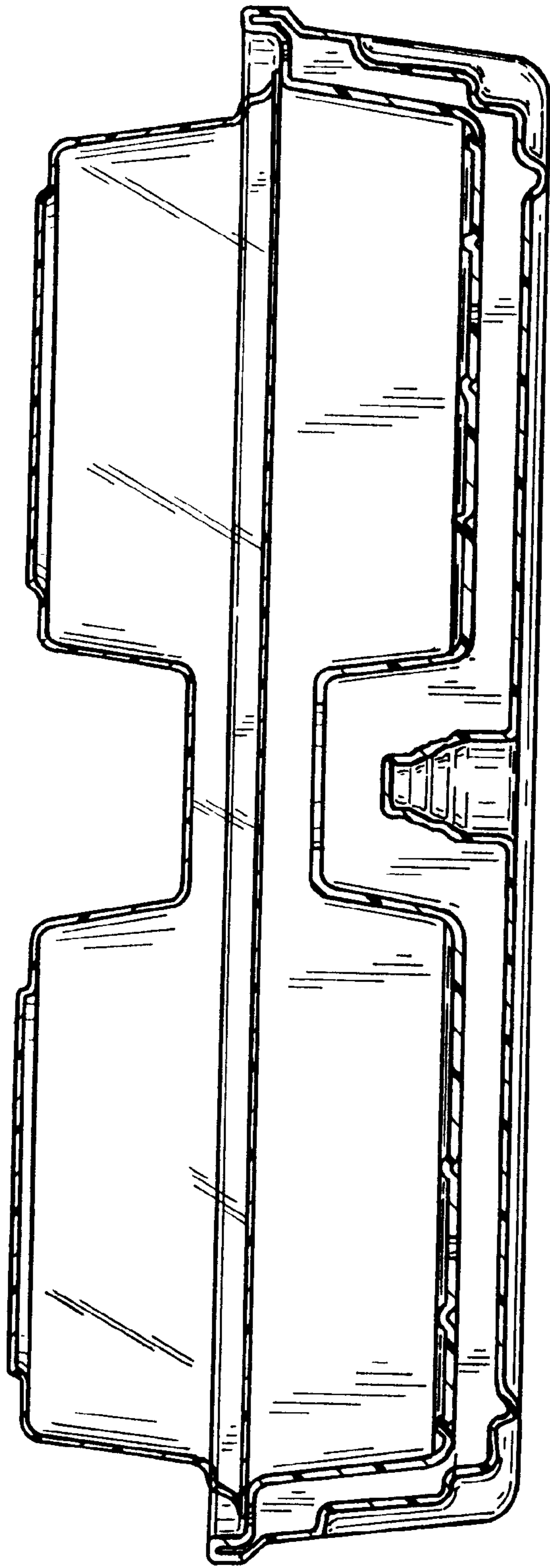

FIG. 6