



US00D409594S

# United States Patent [19] Lepack

[11] Patent Number: Des. 409,594

[45] Date of Patent: \*\* May 11, 1999

[54] **COMBINED KEYBOARD AND KEYBOARD STAND**

[75] Inventor: **Robert Kenneth Lepack**, Calgary, Canada

[73] Assignee: **Northern Telecom Limited**, Montreal, Canada

[\*\*] Term: **14 Years**

[21] Appl. No.: **29/091,644**

[22] Filed: **Aug. 3, 1998**

[51] **LOC (6) Cl.** ..... **14-02**

[52] **U.S. Cl.** ..... **D14/115; D14/114**

[58] **Field of Search** ..... D14/100, 106, D14/101, 115; D18/1, 2, 7; 235/145 A, 145 R; 178/17 A, 17 C; 200/5 A, 5 R, 6 A, 6 R; 345/168, 160; 341/22, 23; 364/708.1; 400/472, 479, 484-486, 488, 489

[56] **References Cited**

**U.S. PATENT DOCUMENTS**

D. 325,199	4/1992	Gowda et al.	.....	D14/115
D. 354,053	1/1995	Kao	.....	D14/115
D. 387,051	12/1997	Peng	.....	D14/115
D. 389,136	1/1998	Behar et al.	.....	D14/115

*Primary Examiner*—Freda Nunn

[57] **CLAIM**

The ornamental design for a combined keyboard and keyboard stand, as shown and described.

**DESCRIPTION**

FIG. 1 is a top plan view of the combined keyboard and keyboard stand embodying the design wherein the keyboard is shown separately for clarity of illustration only;

FIG. 2 is a bottom plan view thereof;

FIG. 3 is a right side elevational view thereof, the left side being a mirror image;

FIG. 4 is a front perspective view thereof;

FIG. 5 is a rear elevational view thereof;

FIG. 6 is a front perspective view taken from above and one side;

FIG. 7 is a top plan view of the keyboard stand shown separately for clarity of illustration only;

FIG. 8 is an underneath plan view thereof;

FIG. 9 is a rear elevation thereof;

FIG. 10 is a front elevation thereof;

FIG. 11 is a left side elevation thereof, the right side elevation being a mirror image;

FIG. 12 is a left side elevation of the keyboard in combination with the keyboard stand; and,

FIG. 13 is a front elevation of the keyboard in combination with the keyboard stand.

**1 Claim, 7 Drawing Sheets**

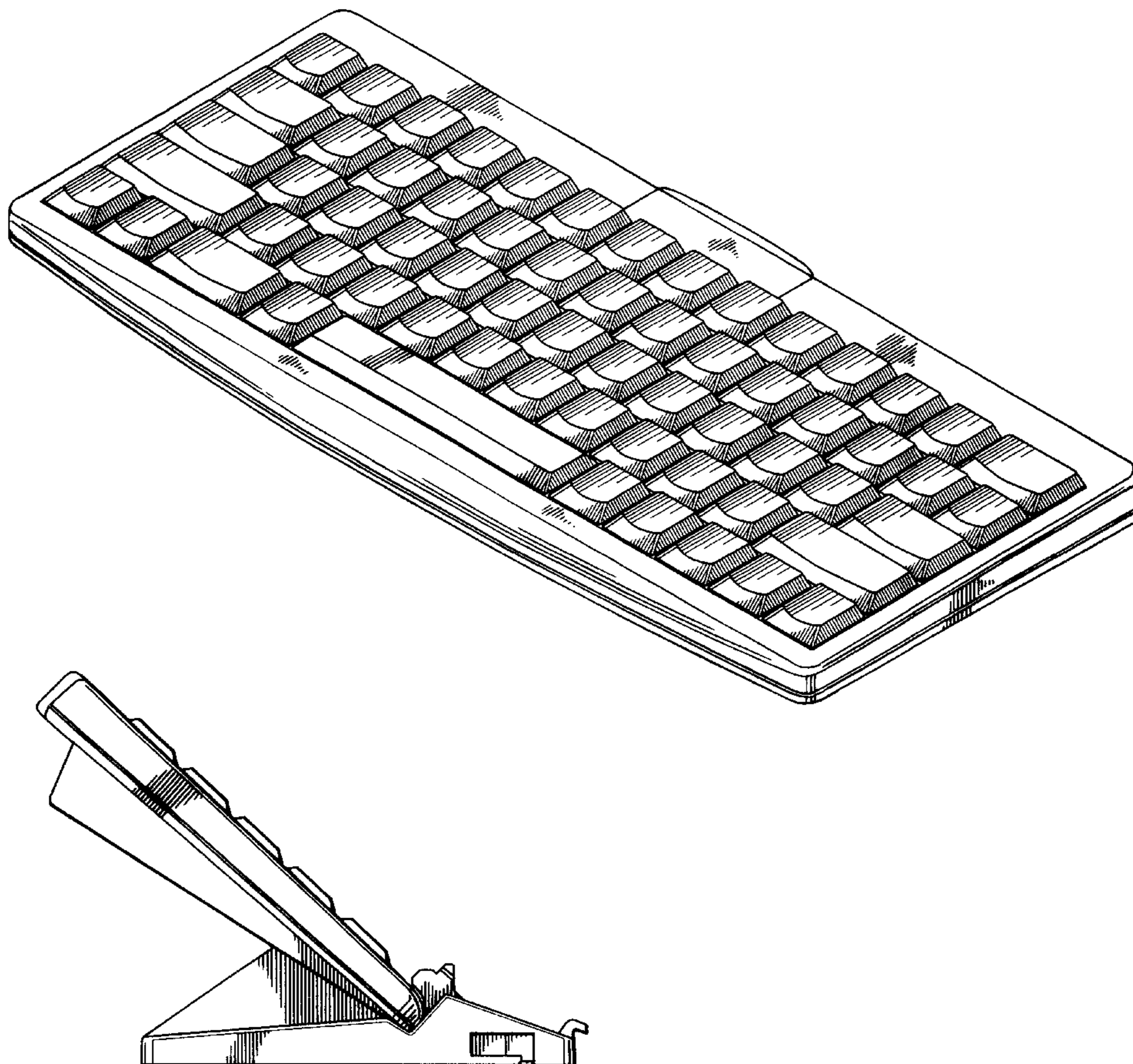

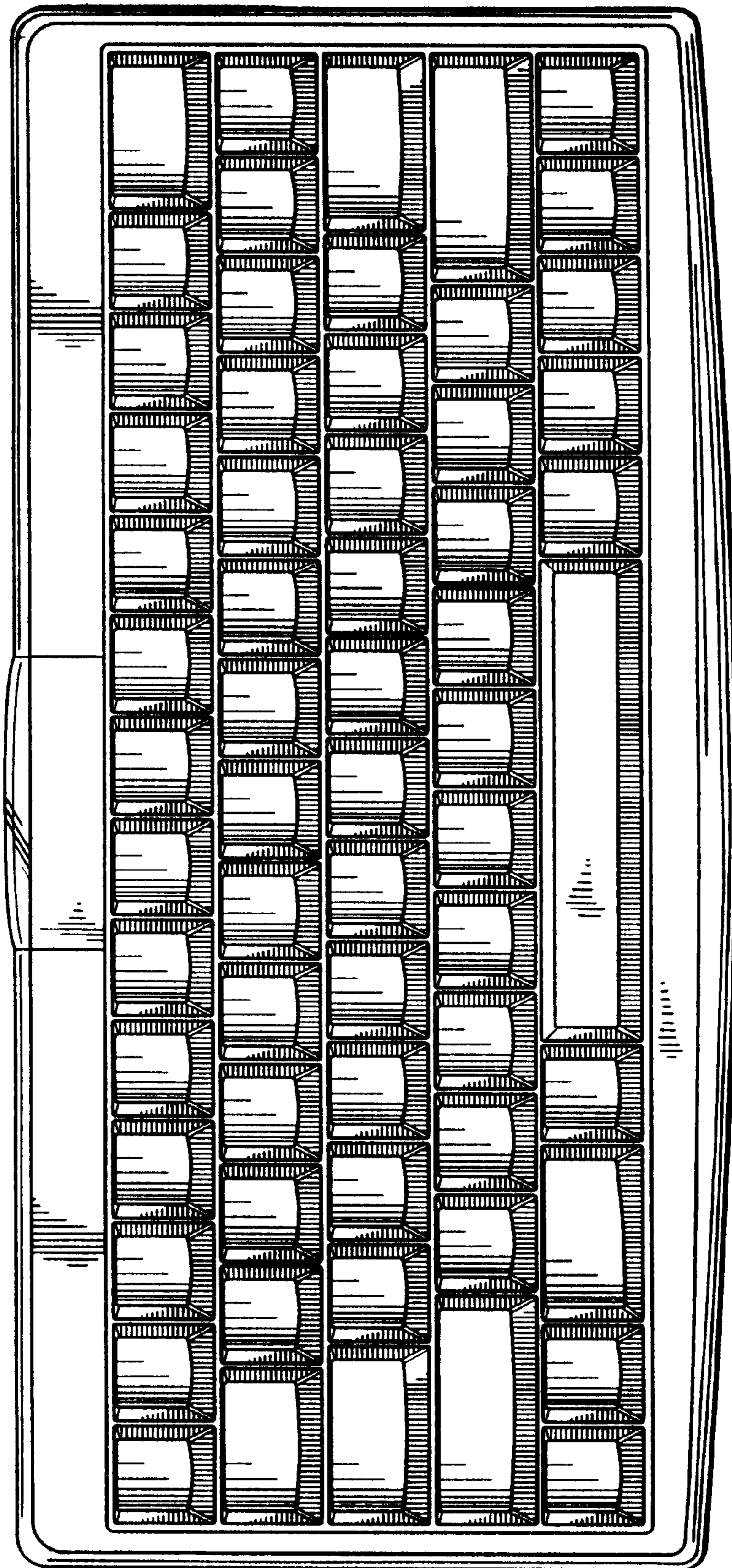

FIG. 1

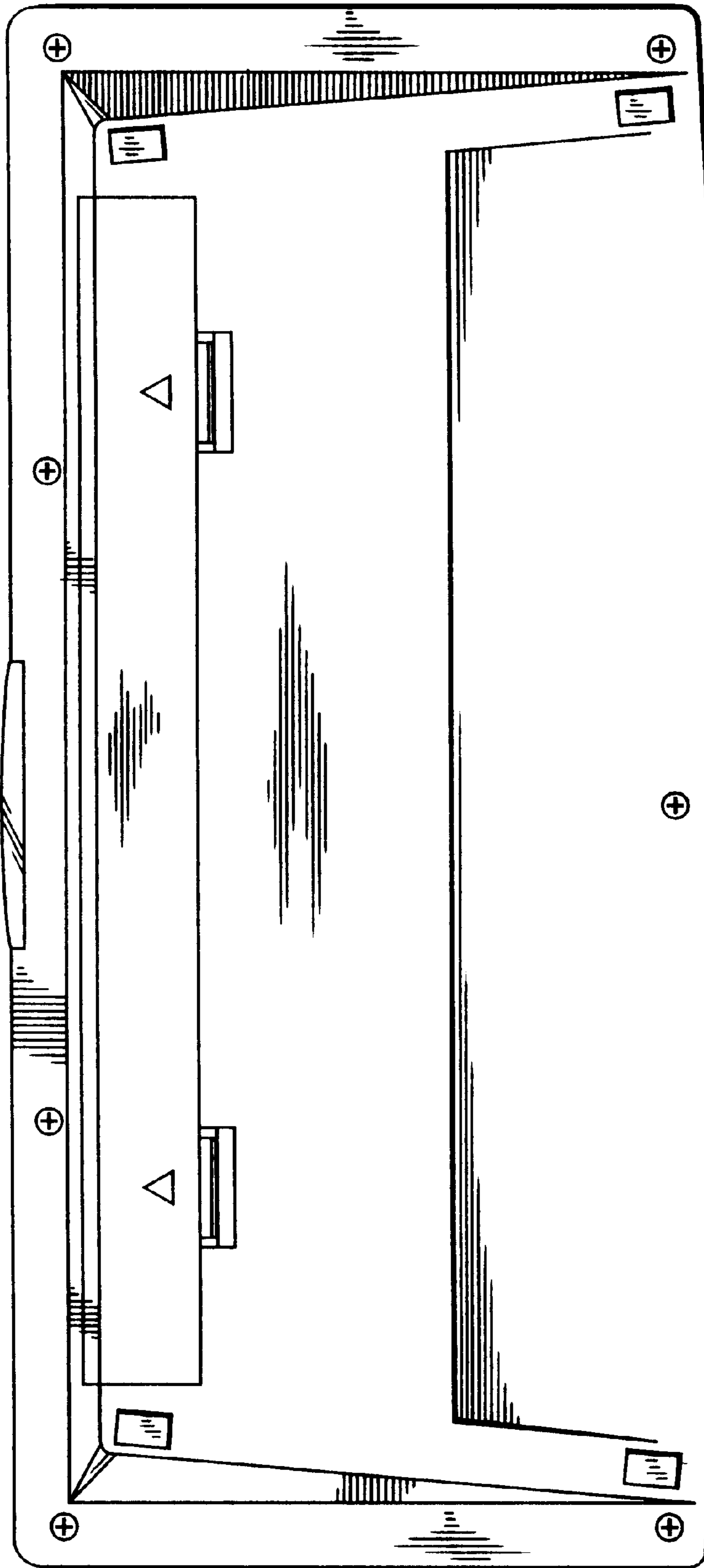
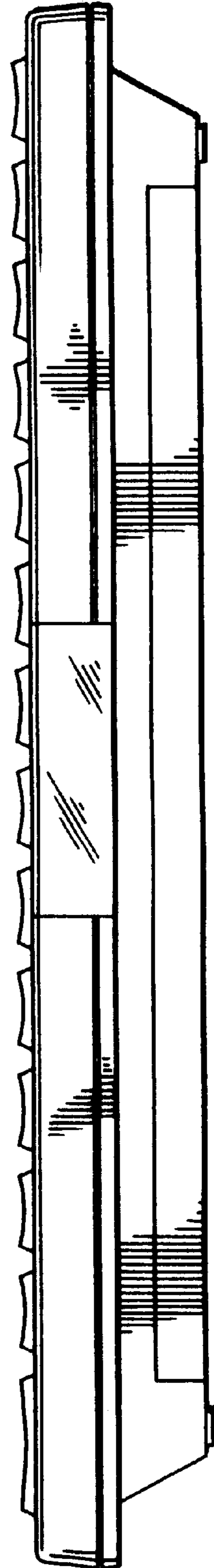
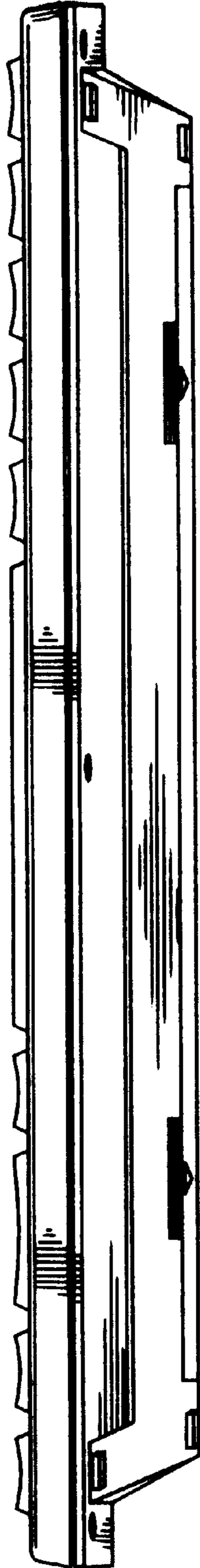
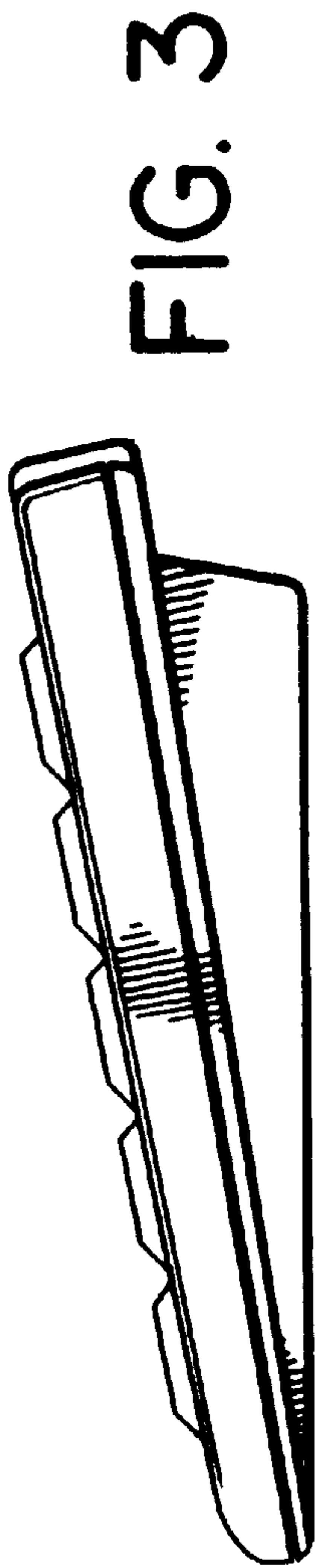

FIG. 2



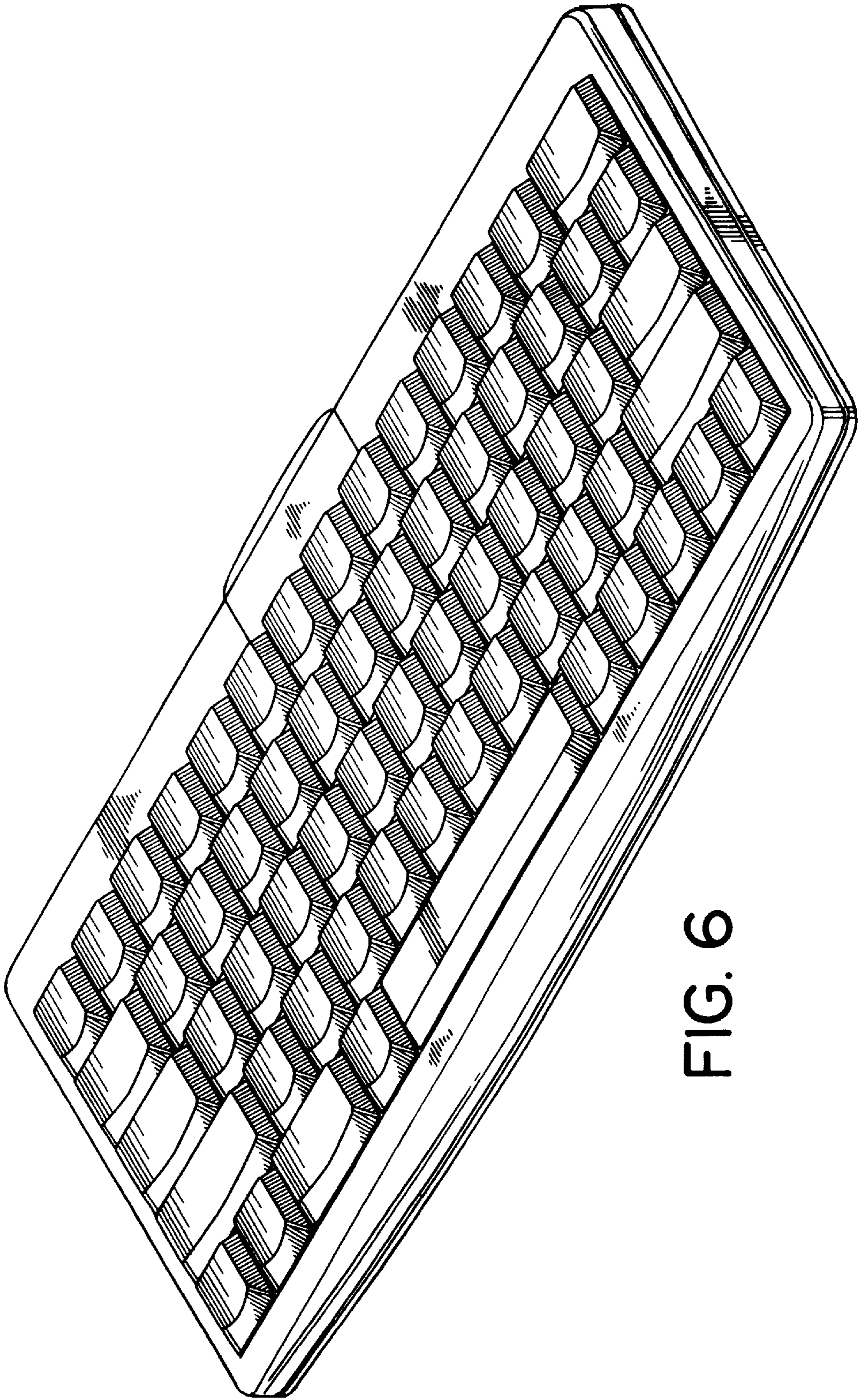

FIG. 6

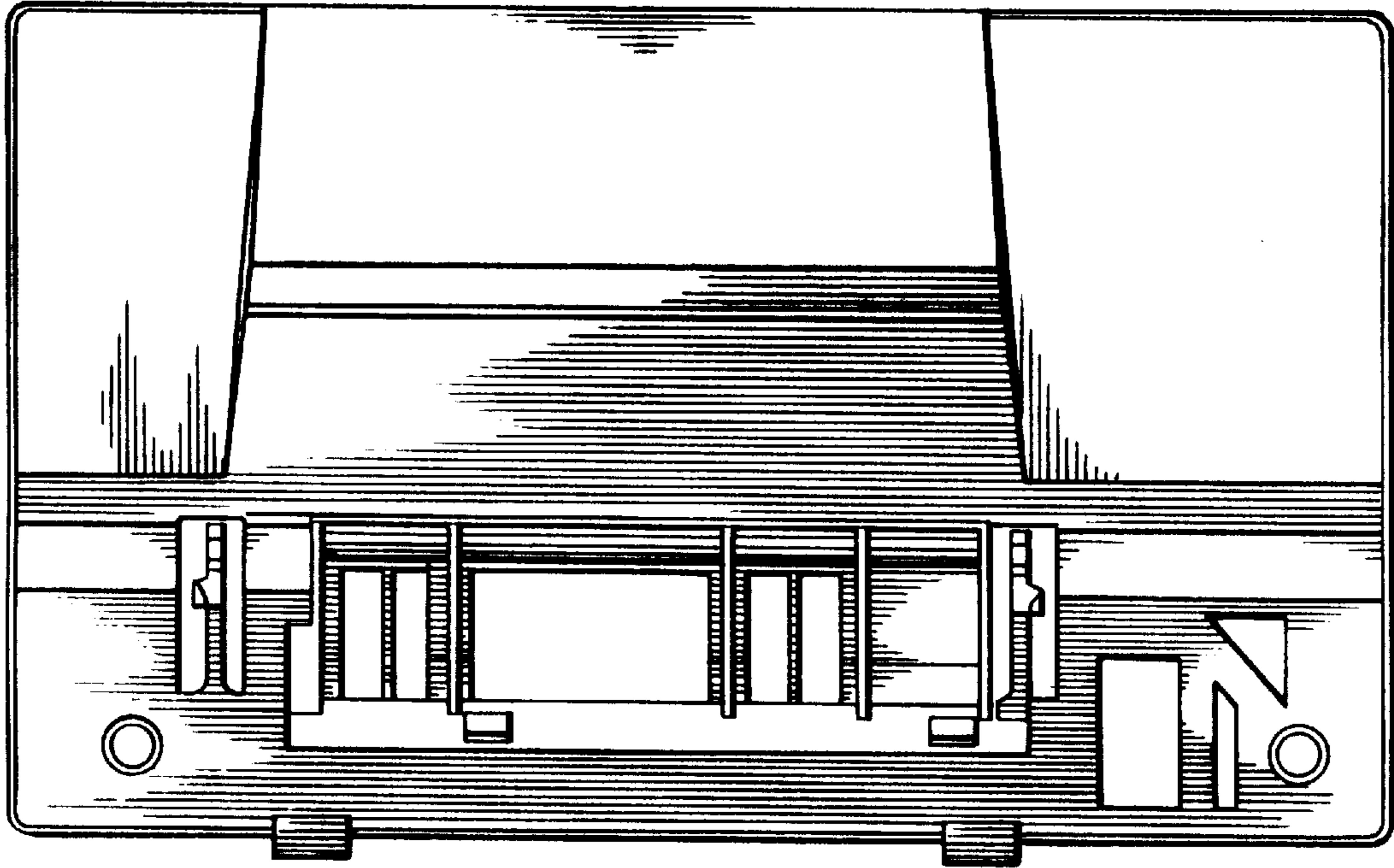

FIG. 7

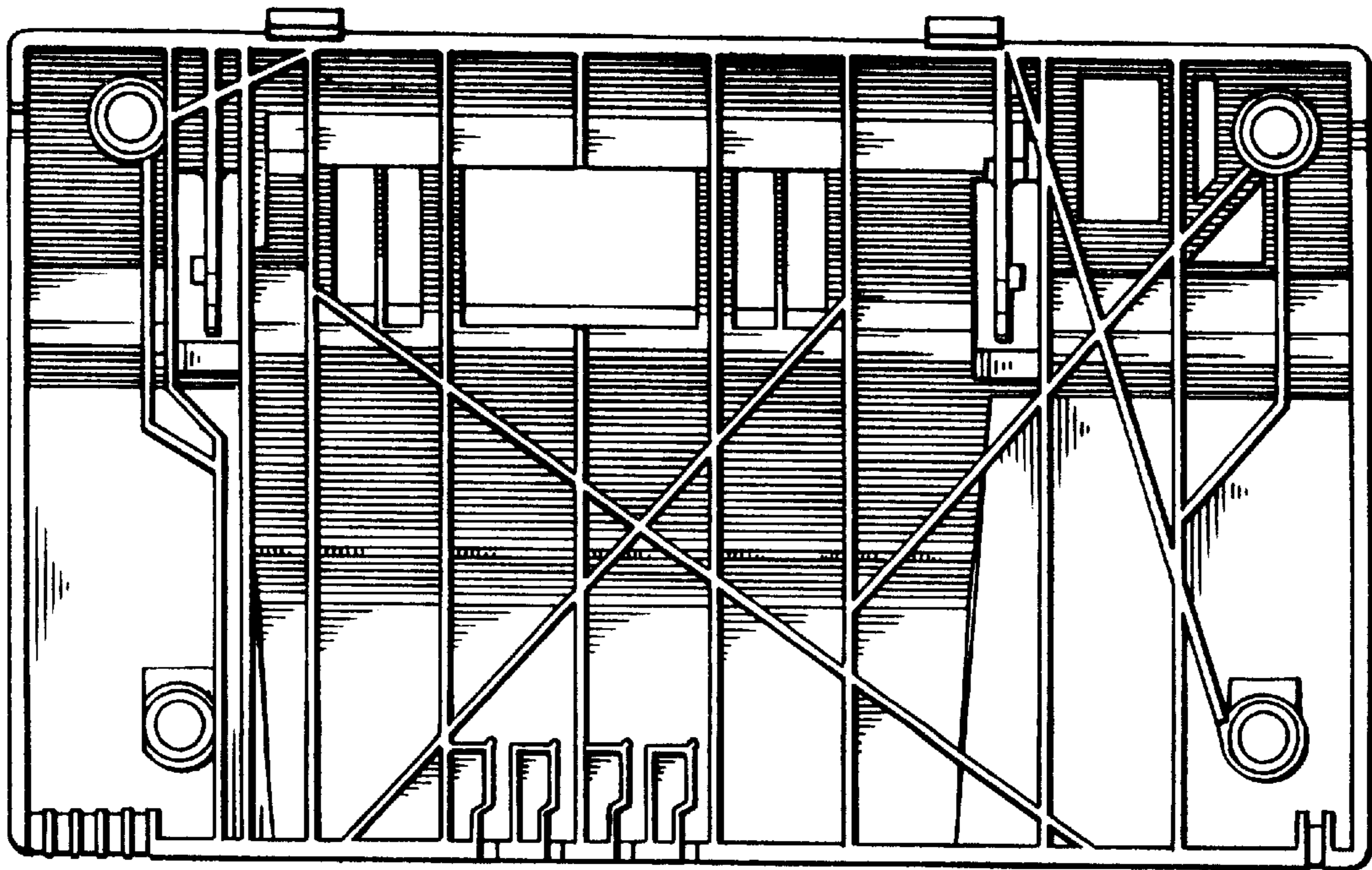

FIG. 8

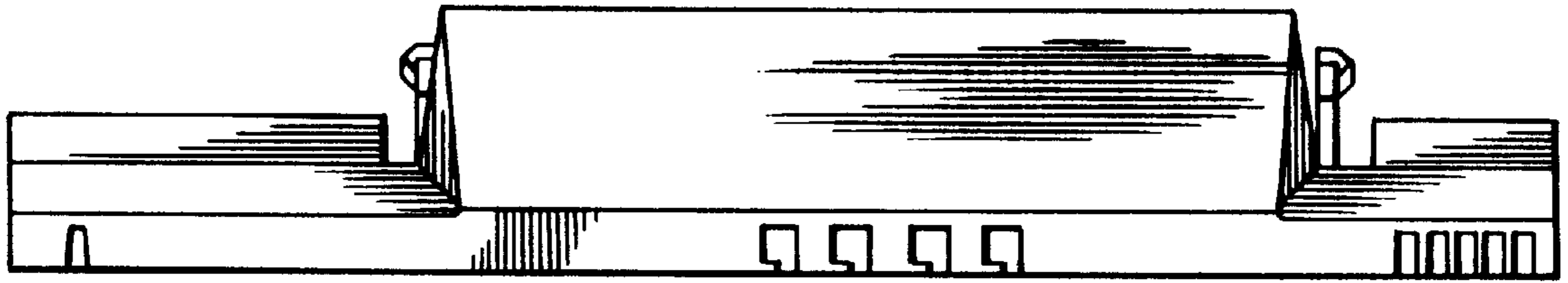

FIG. 9

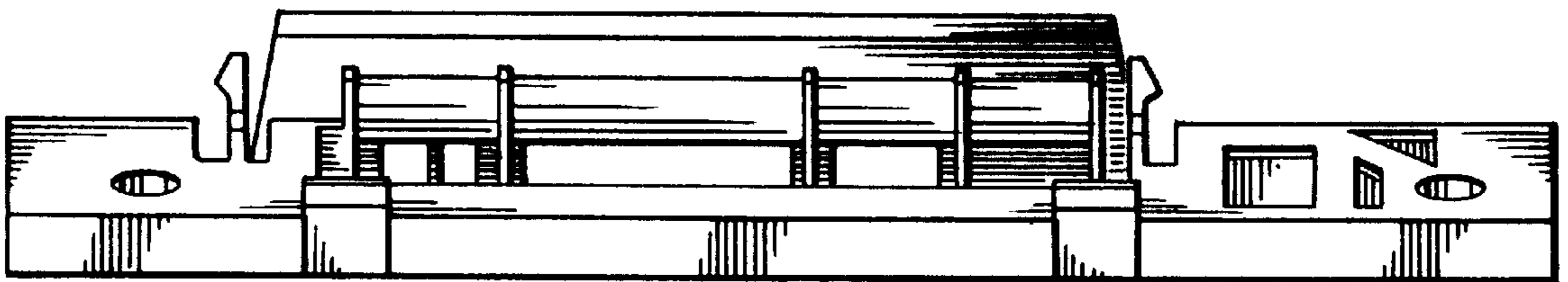

FIG. 10

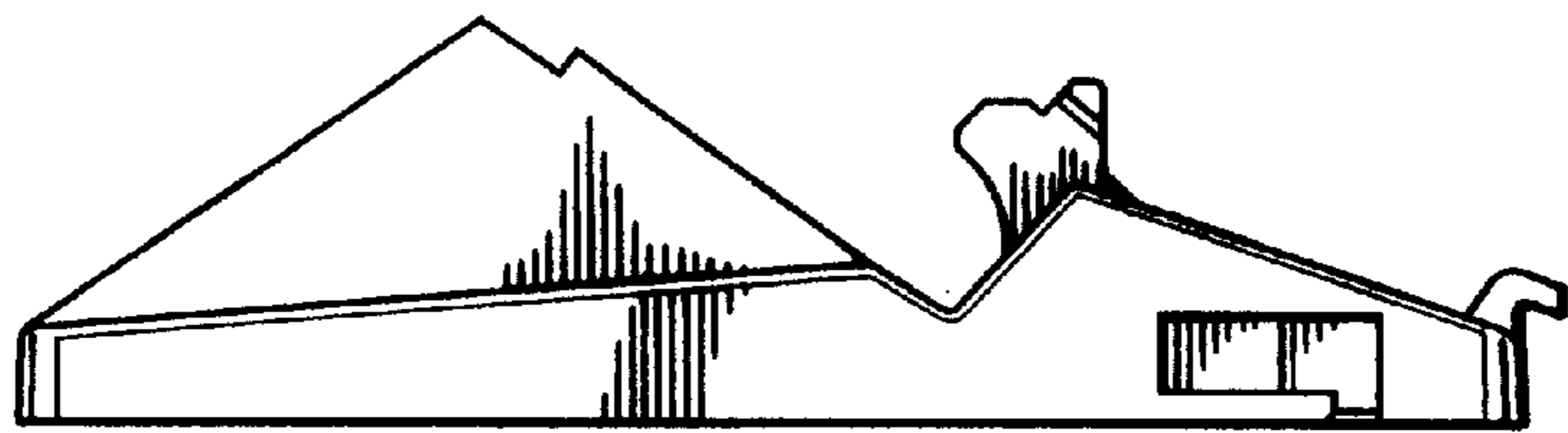

FIG. 11

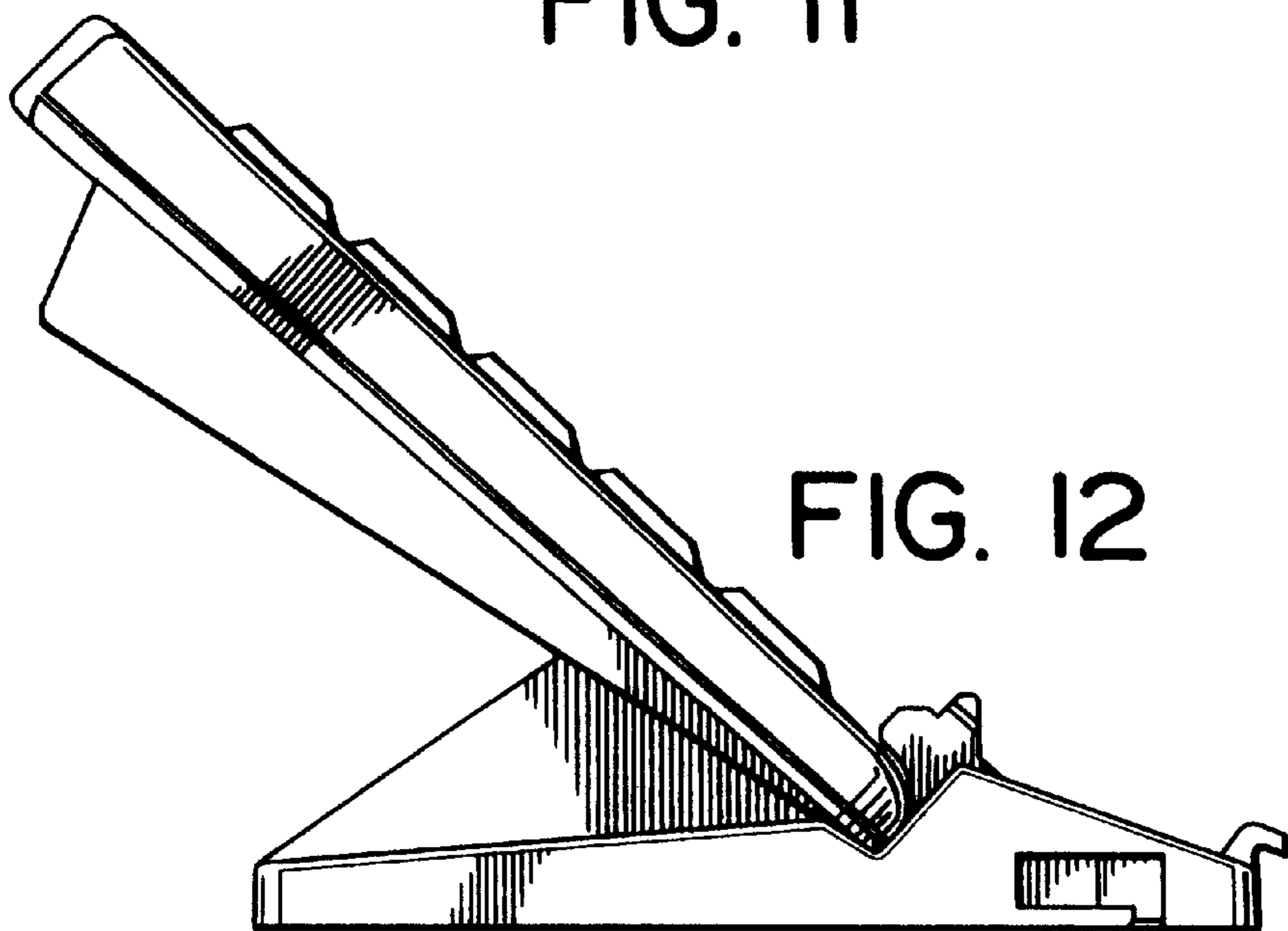

FIG. 12

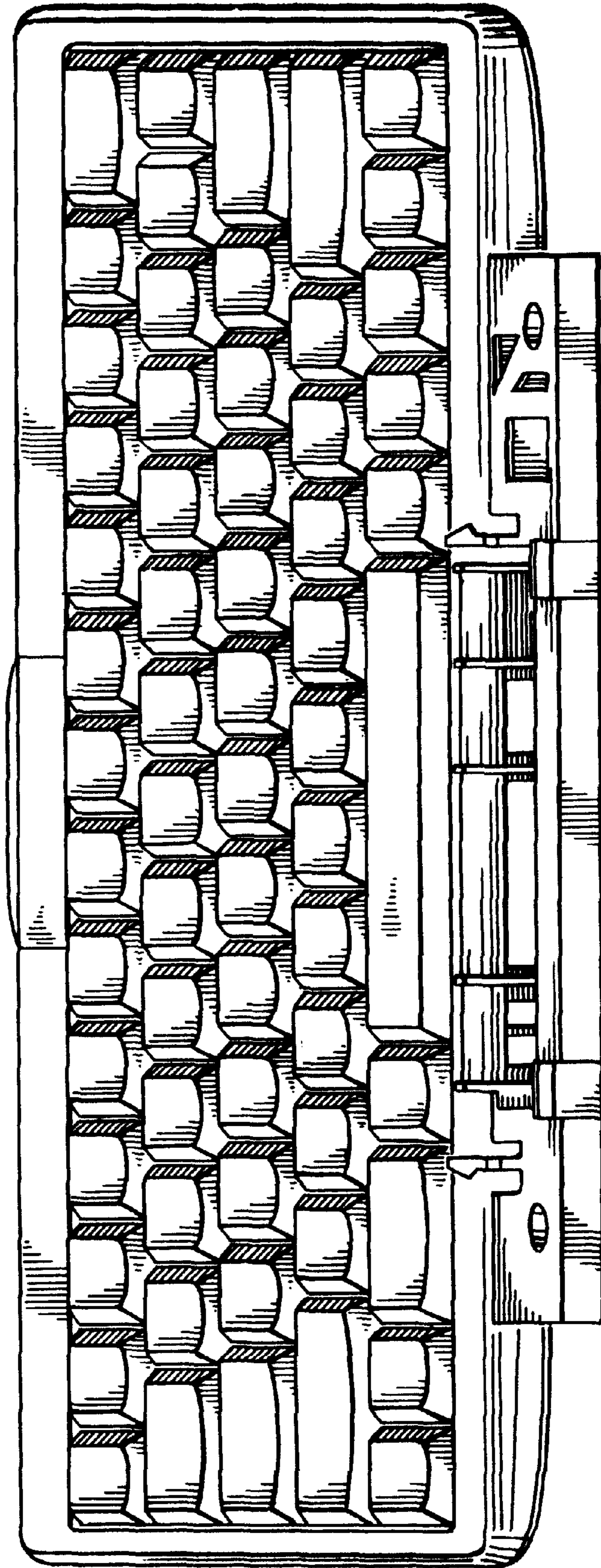

FIG. 13