

US00D409562S

# United States Patent [19]

Johansson et al.

[11] Patent Number: **Des. 409,562**

[45] Date of Patent: **\*\* May 11, 1999**

[54] **BATTERY**

[75] Inventors: **Panu Johansson**, Tampere, Finland;  
**Marc Tappeiner**, Santa Barbara;  
**Sheldon Phillips**, Agoura, both of Calif.

[73] Assignee: **Nokia Mobile Phones Limited**, Espoo,  
Finland

[\*\*] Term: **14 Years**

[21] Appl. No.: **29/084,282**

[22] Filed: **Feb. 27, 1998**

[51] **LOC (6) Cl.** ..... **13-02**

[52] **U.S. Cl.** ..... **D13/103**

[58] **Field of Search** ..... D13/103; 429/96-100,  
429/167, 176

|            |         |                    |         |
|------------|---------|--------------------|---------|
| D. 361,309 | 8/1995  | White .....        | D13/103 |
| D. 374,424 | 10/1996 | Nagele et al. .... | D13/103 |
| D. 375,932 | 11/1996 | Nagele et al. .... | D13/103 |
| D. 376,127 | 12/1996 | Nagele et al. .... | D13/103 |
| D. 384,939 | 10/1997 | Liebler .....      | D13/103 |
| D. 387,727 | 12/1997 | Settsu et al. .... | D13/103 |
| D. 388,763 | 1/1998  | Nuovo et al. ....  | D13/103 |
| D. 389,116 | 1/1998  | Nuovo et al. ....  | D13/103 |
| D. 389,117 | 1/1998  | Nuovo et al. ....  | D13/103 |
| D. 389,118 | 1/1998  | Nuovo et al. ....  | D13/103 |
| D. 389,119 | 1/1998  | Nuovo et al. ....  | D13/103 |

*Primary Examiner*—Joel Sincavage  
*Attorney, Agent, or Firm*—Perman & Green, LLP

### [57] CLAIM

The ornamental design of a “battery,” as shown and described.

### DESCRIPTION

FIG. 1 is a bottom plan view of a battery, showing our new design;  
FIG. 2 is a left side elevational view thereof;  
FIG. 3 is a front elevational view thereof;  
FIG. 4 is a right side elevational view thereof;  
FIG. 5 is a top, rear, left side perspective view thereof;  
FIG. 6 is a top plan view thereof;  
FIG. 7 is a rear elevational view thereof; and,  
FIG. 8 is a bottom, front and left side perspective view thereof.

**1 Claim, 3 Drawing Sheets**

### [56] References Cited

#### U.S. PATENT DOCUMENTS

|            |         |                    |         |
|------------|---------|--------------------|---------|
| D. 321,183 | 10/1991 | Powell et al. .... | D14/138 |
| D. 328,733 | 8/1992  | Seymour .....      | D13/103 |
| D. 331,566 | 12/1992 | Seymour .....      | D13/103 |
| D. 346,580 | 5/1994  | Tattari .....      | D13/103 |
| D. 346,581 | 5/1994  | Tattari .....      | D13/103 |
| D. 349,882 | 8/1994  | Johnson .....      | D13/103 |
| D. 350,110 | 8/1994  | Johnson .....      | D13/103 |
| D. 357,896 | 5/1995  | Berry .....        | D13/103 |
| D. 358,127 | 5/1995  | Berry .....        | D13/103 |
| D. 358,128 | 5/1995  | Berry et al. ....  | D13/103 |
| D. 359,267 | 6/1995  | Berry et al. ....  | D13/103 |

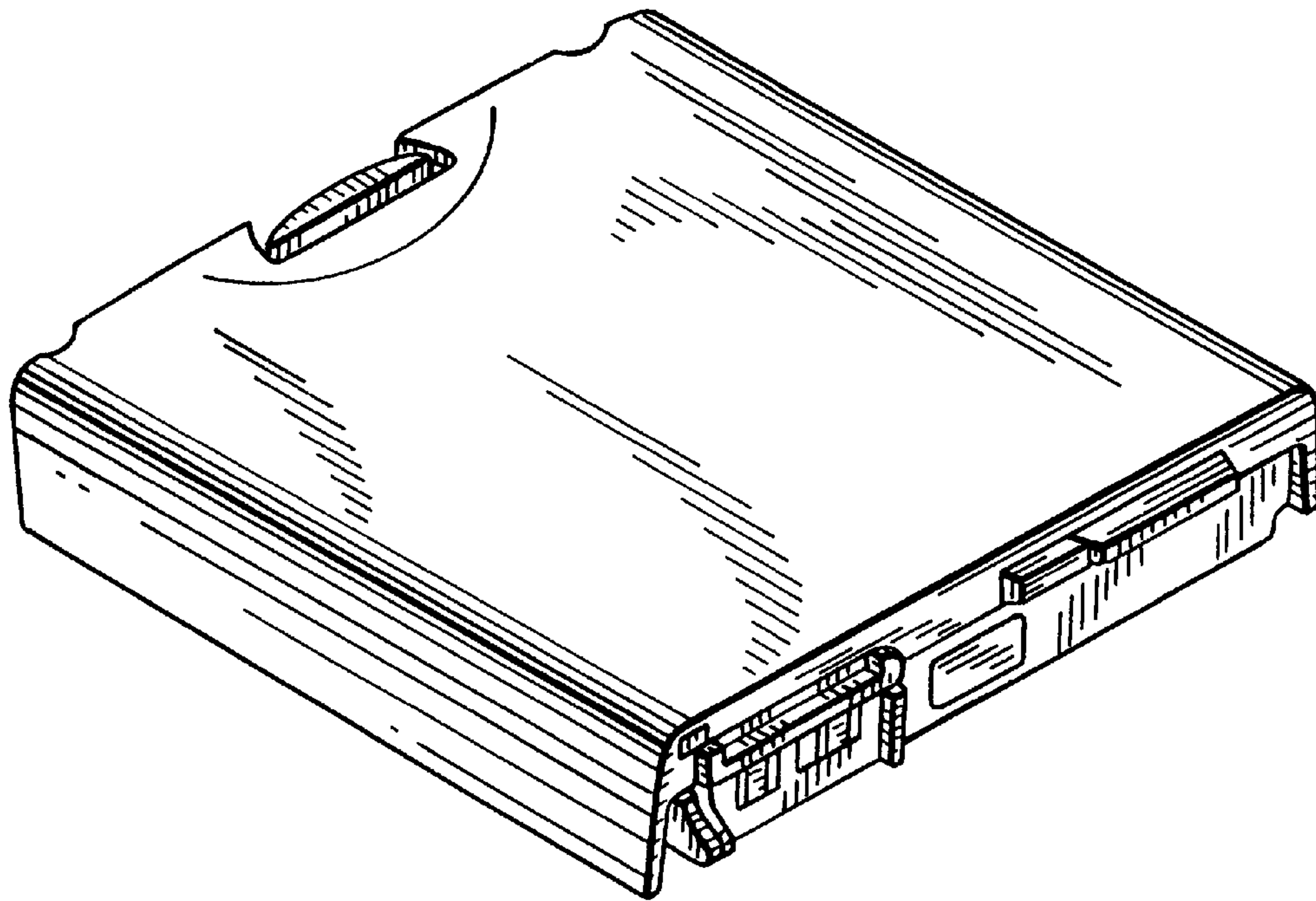
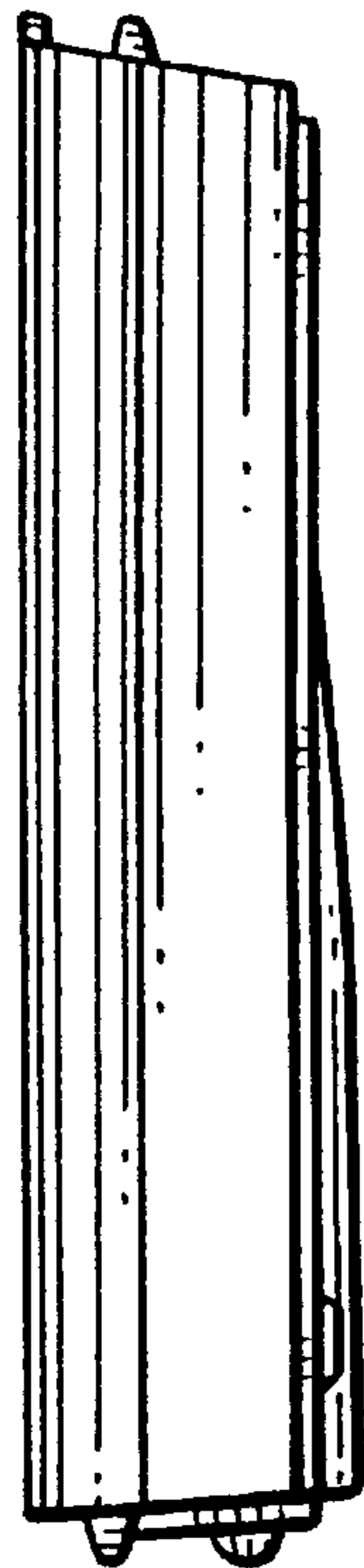

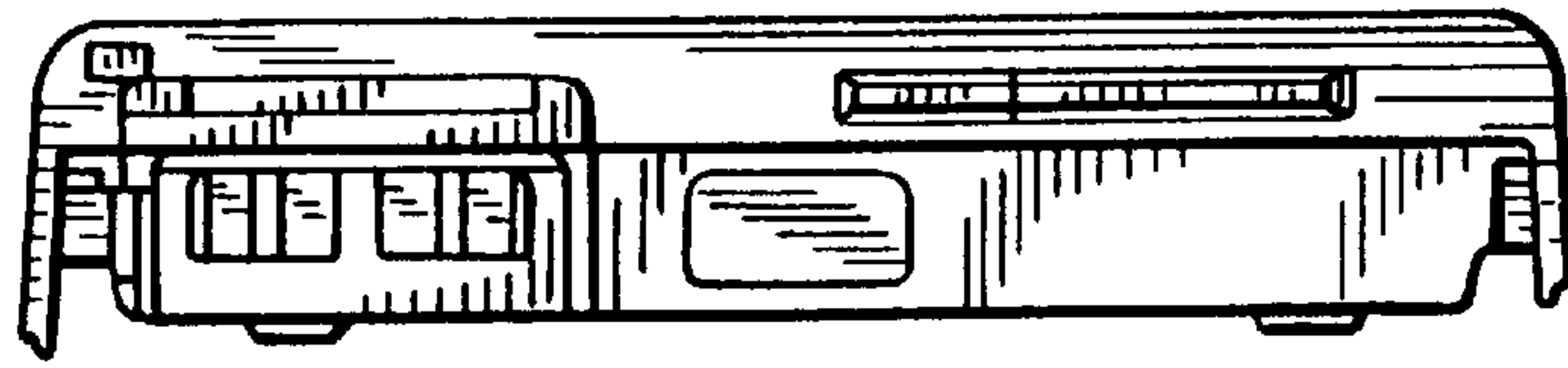

FIG. 1



FIG. 2

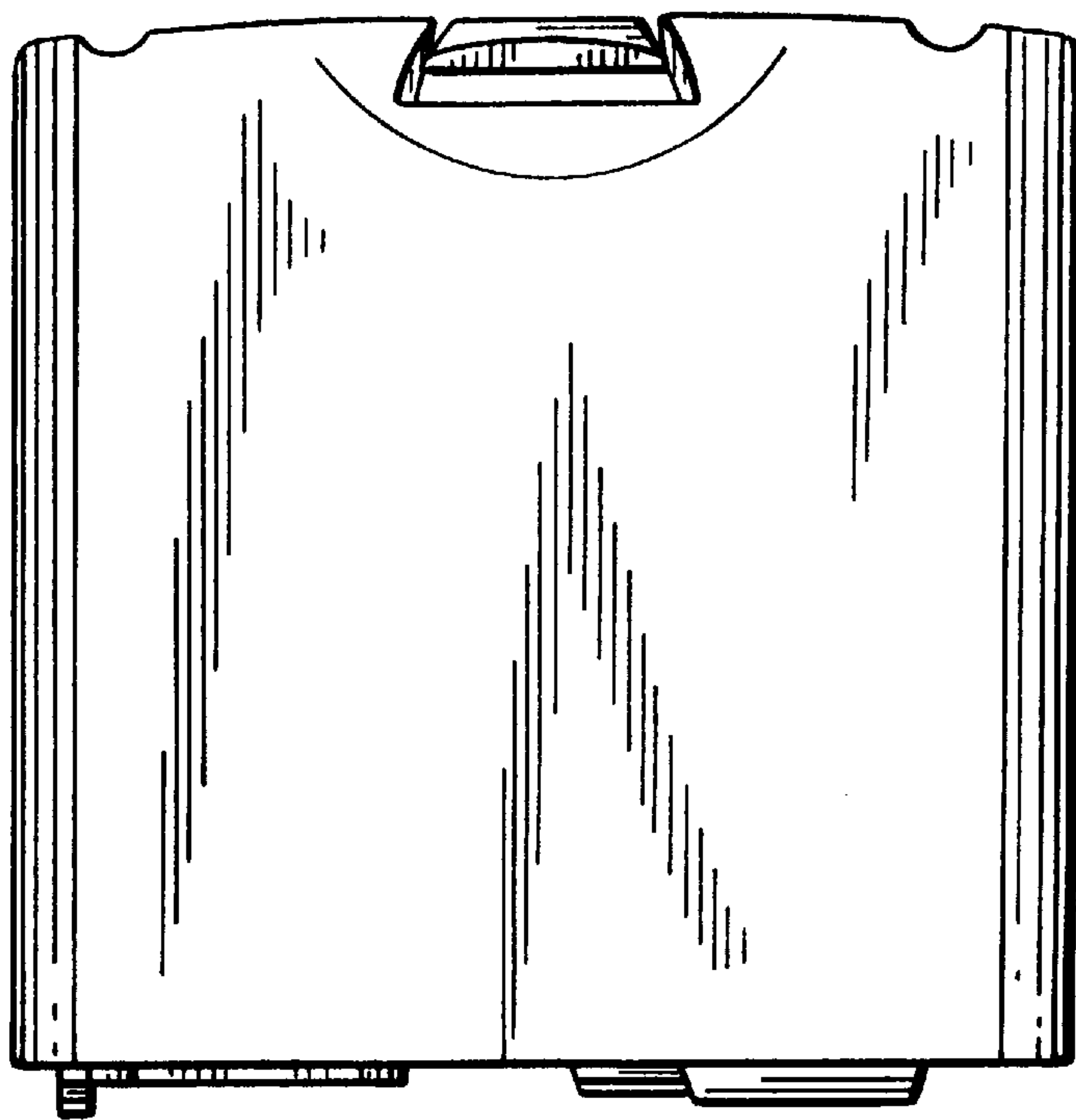

FIG. 3



FIG. 4

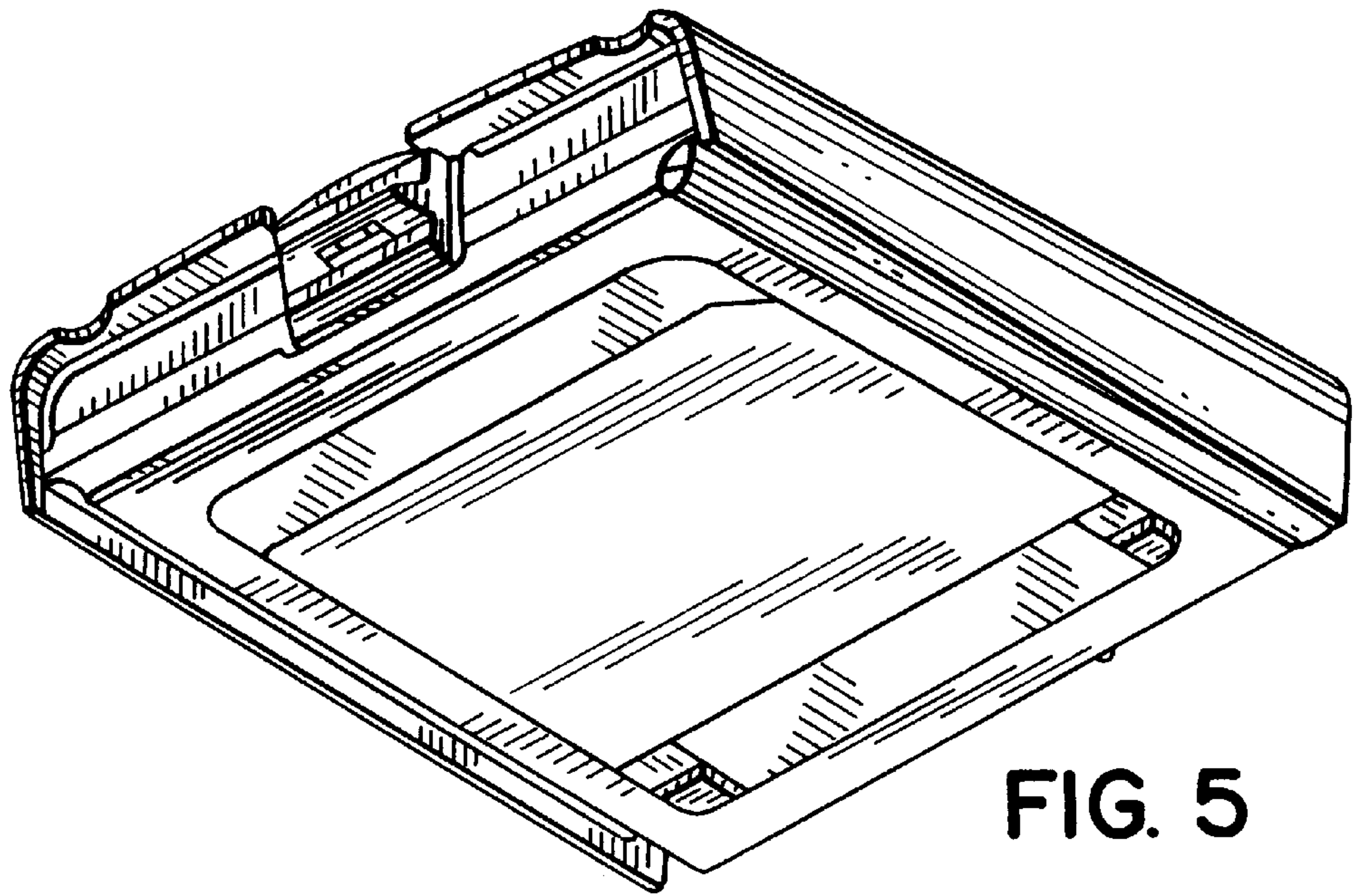

FIG. 5

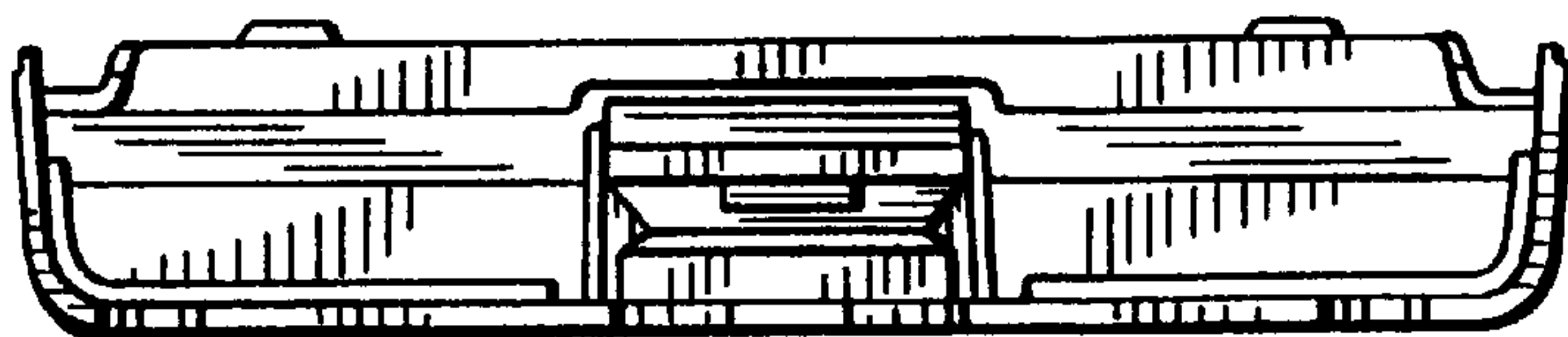

FIG. 6



FIG. 7

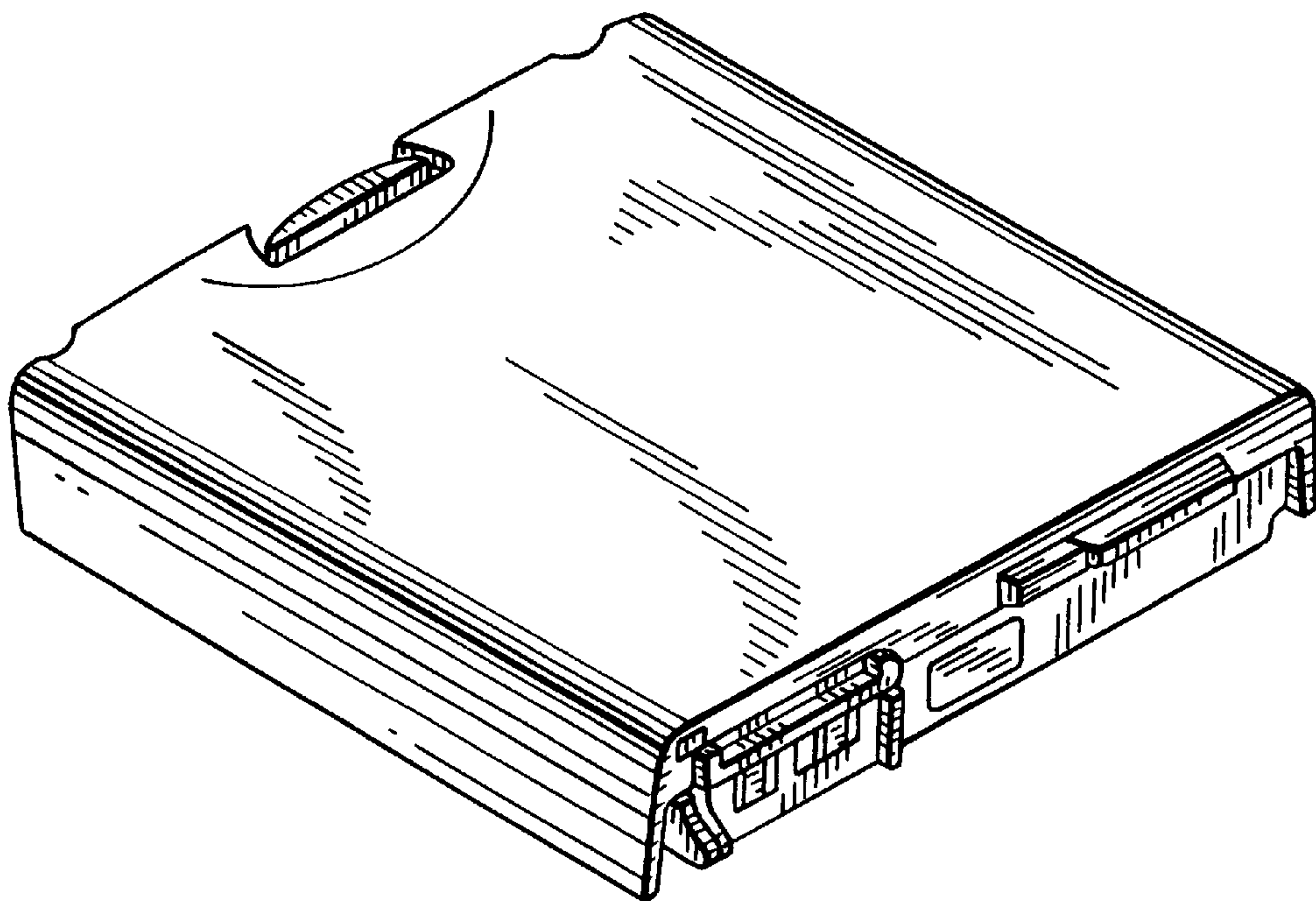
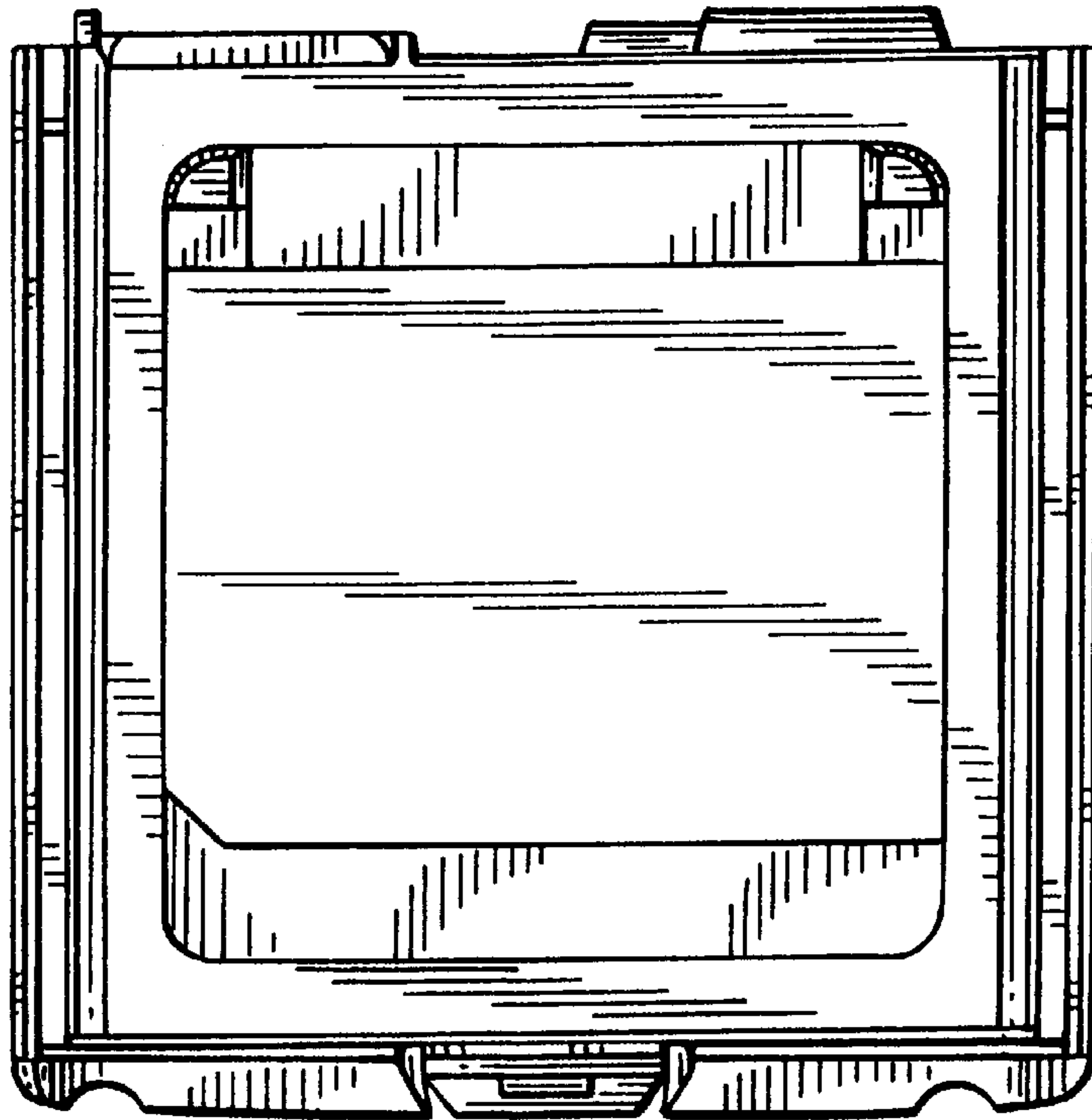

FIG. 8