



US00D409537S

United States Patent [19]
Adelaar

[11] **Patent Number: Des. 409,537**

[45] **Date of Patent: ** May 11, 1999**

[54] **SOCCER BALL HITCH COVER**
[76] Inventor: **Antoine Adelaar**, Panoven 4B, 3401
RB Usselstein, Netherlands
[**] Term: **14 Years**
[21] Appl. No.: **29/067,384**
[22] Filed: **Mar. 5, 1997**
[51] **LOC (6) Cl.** **12-16**
[52] **U.S. Cl.** **D12/162**
[58] **Field of Search** D12/162; D9/307,
D9/441, 451; 280/507, 511

4,861,062 8/1989 Stidsen 280/507
4,955,968 9/1990 Beckerer, Jr. 280/507
5,037,122 8/1991 Beckerer, Jr. 280/507

Primary Examiner—Doris V. Coles
Assistant Examiner—Stacia Sinuik
Attorney, Agent, or Firm—Miller, Sisson, Chapman &
Nash, P.C.

[57] **CLAIM**

The ornamental design of a soccer ball hitch cover, as shown and described.

DESCRIPTION

FIG. 1 is a left, front, and bottom perspective view of a soccer ball hitch cover, showing my new design; FIG. 2 is a top plan view thereof; FIG. 3 is a front elevation view thereof; FIG. 4 is a left side elevation view thereof; FIG. 5 is a right side elevation view thereof; FIG. 6 is a rear elevation view thereof; and, FIG. 7 is a bottom plan view thereof.

[56] **References Cited**

U.S. PATENT DOCUMENTS

D. 317,890 7/1991 Bachmann D12/162
D. 336,880 6/1993 Drummond D12/162
D. 342,472 12/1993 Harper D12/162
D. 357,541 4/1995 Neidell D9/451 X
D. 358,794 5/1995 Thigpen D12/162
D. 359,018 6/1995 Thigpen D12/162
4,738,293 4/1988 Ostrom et al. D12/162 X

1 Claim, 4 Drawing Sheets

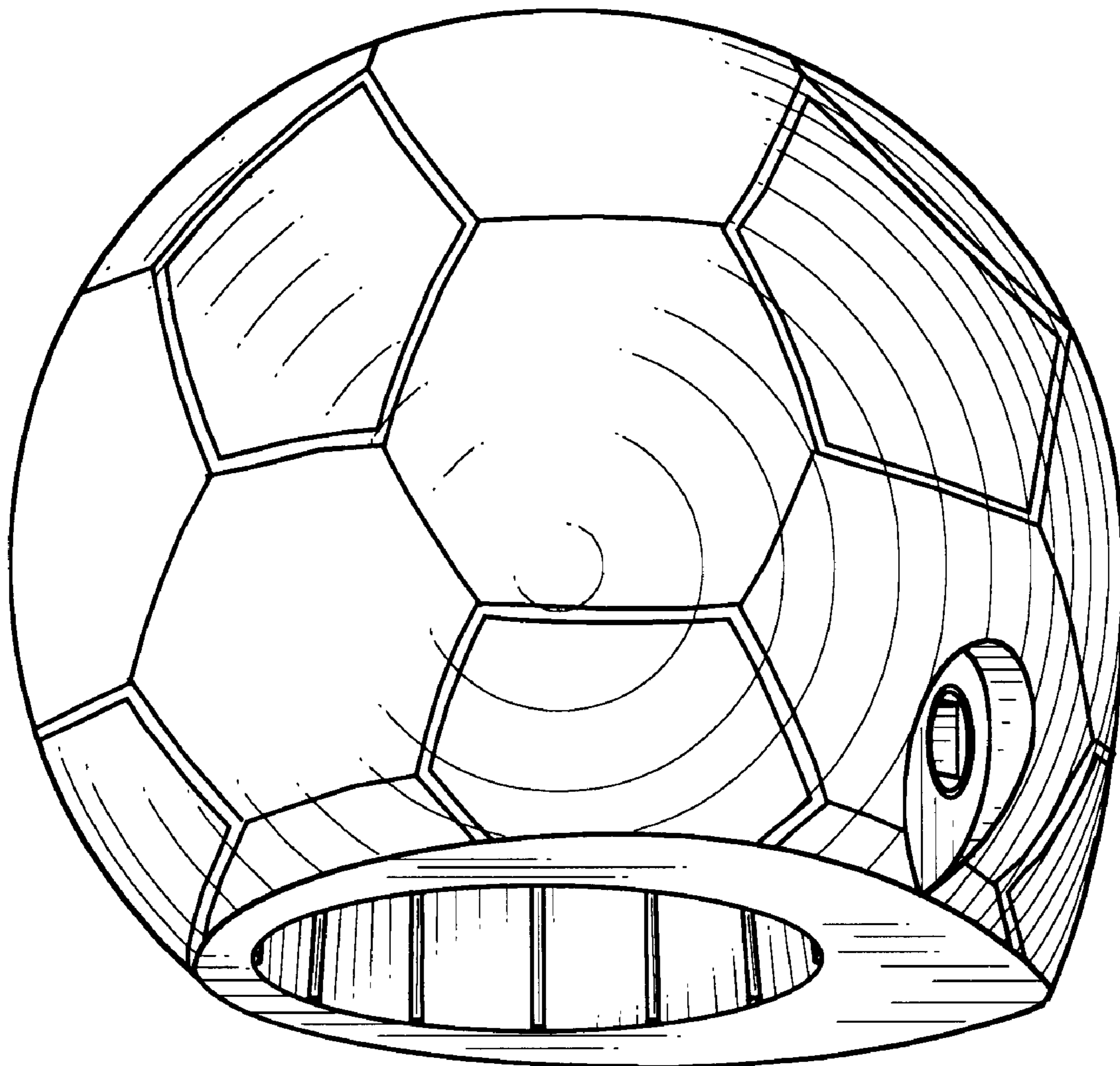

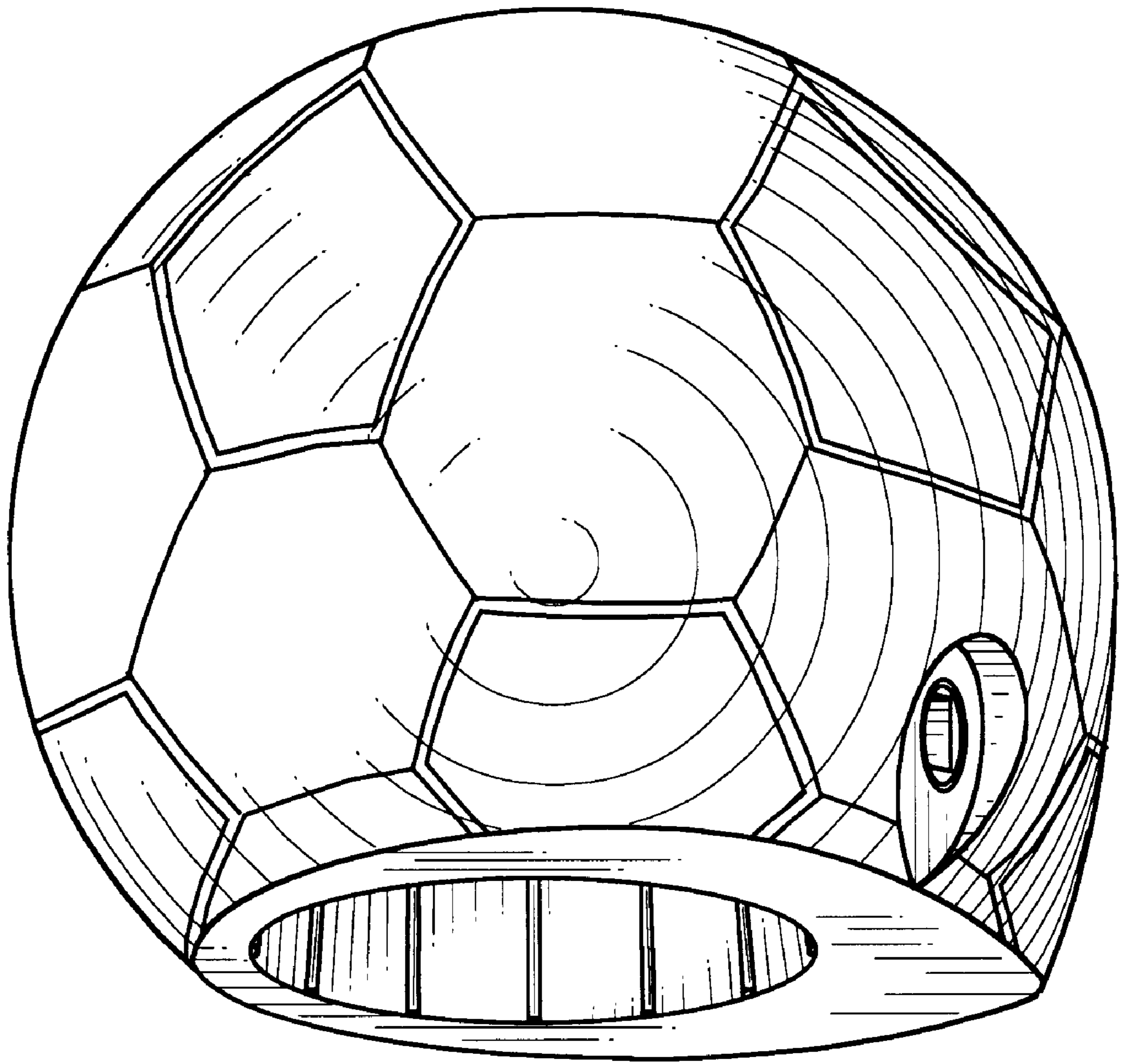

Fig. 1

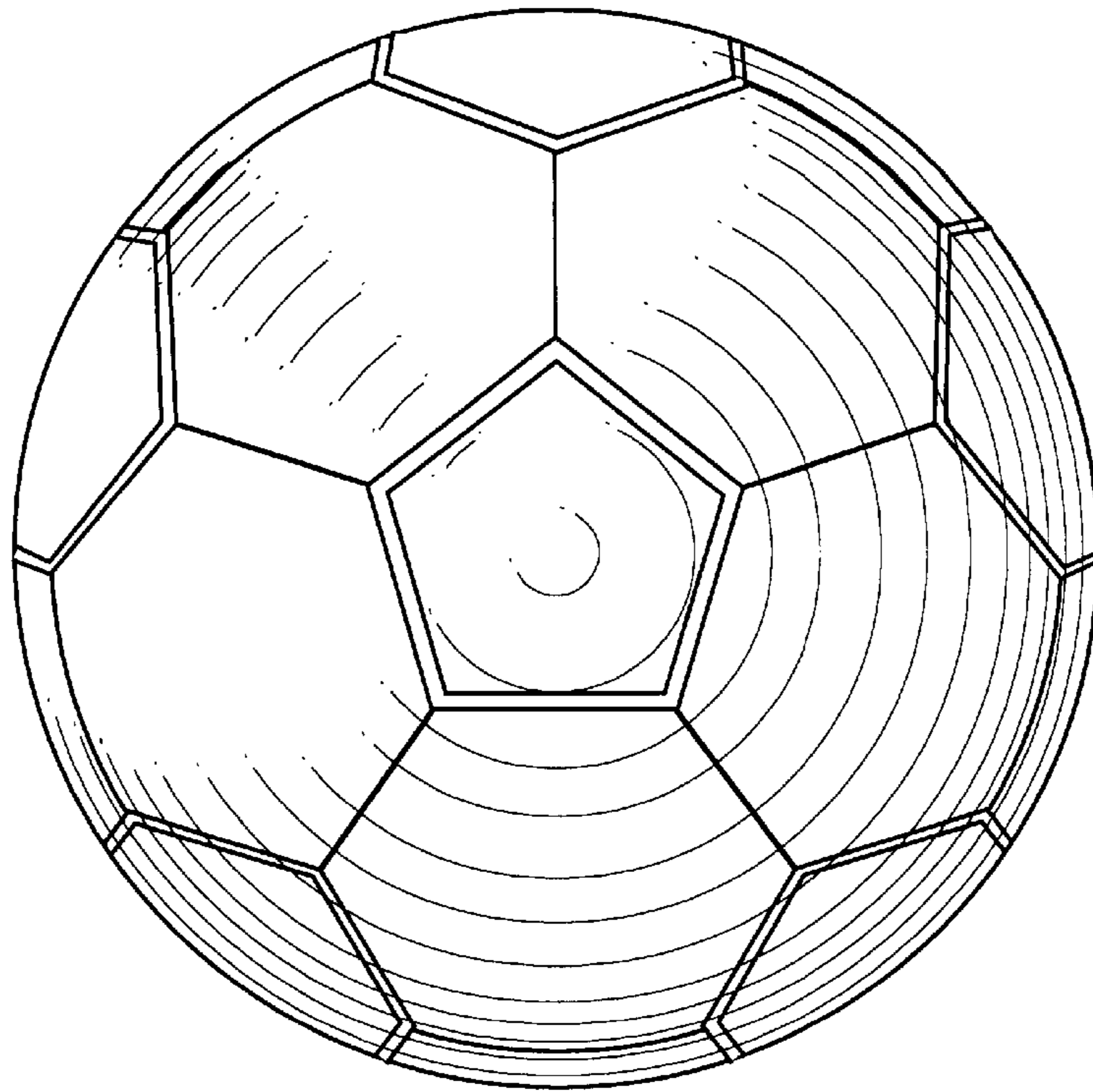

Fig. 2

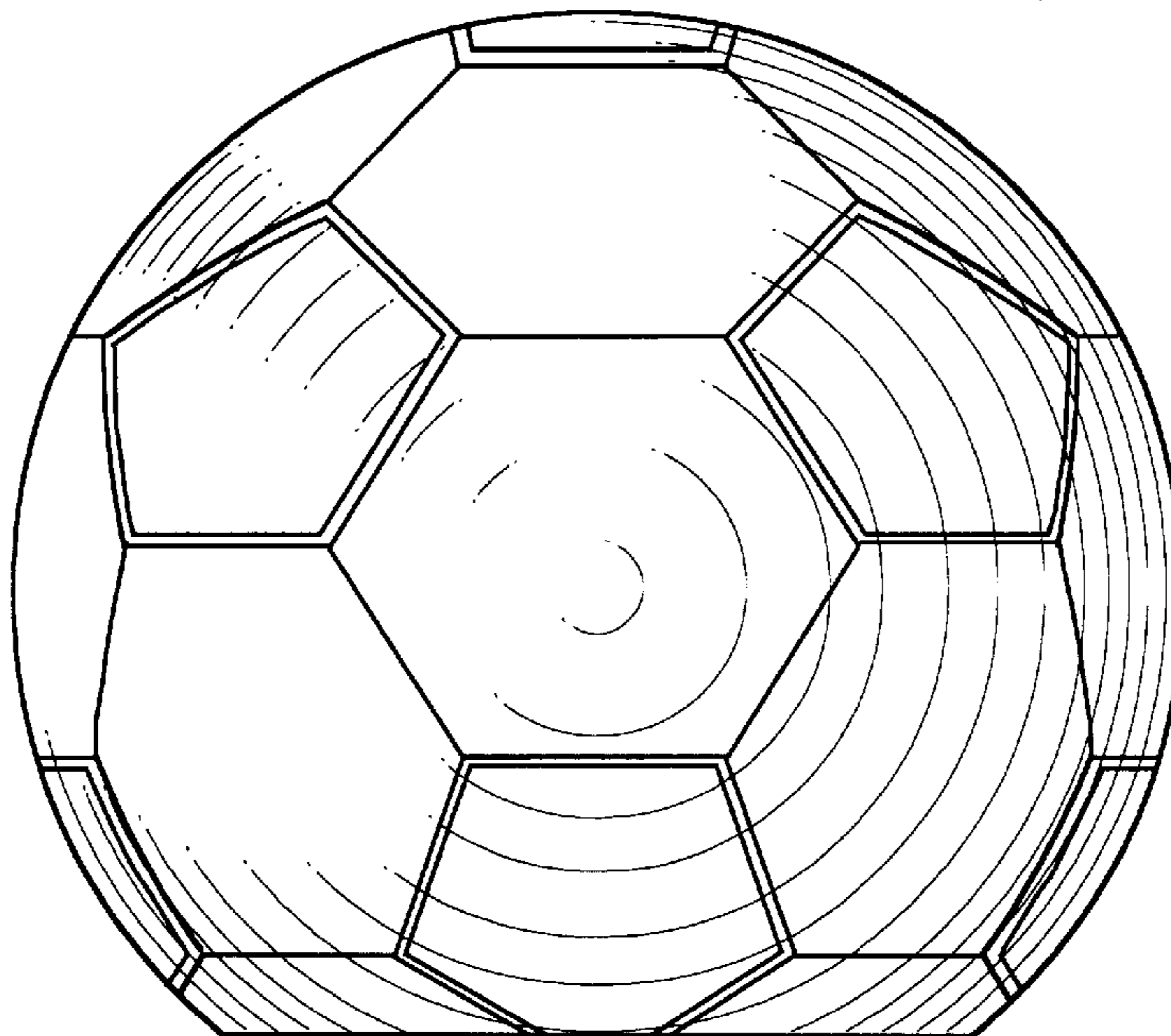

Fig. 3

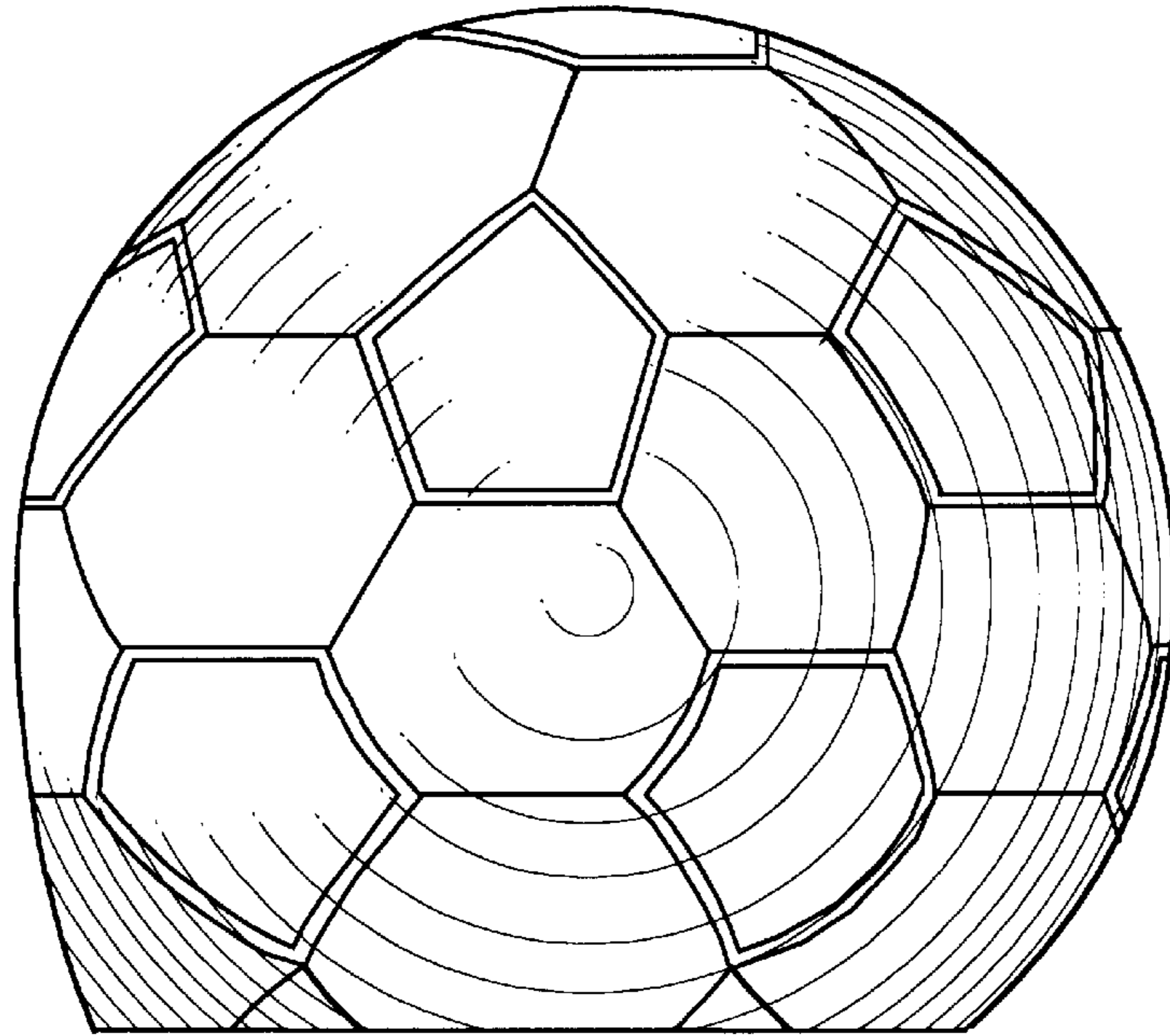

Fig. 4

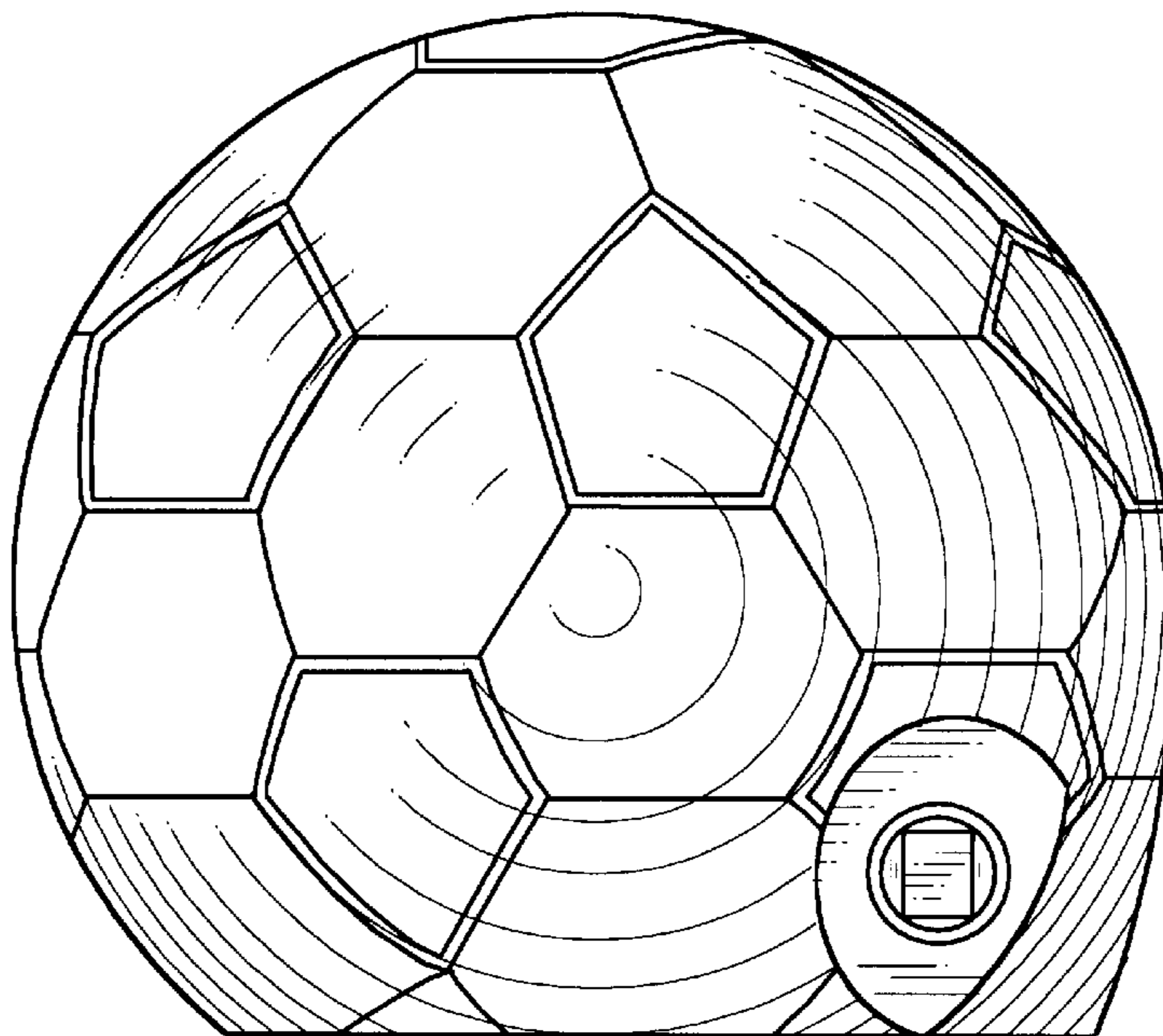

Fig. 5

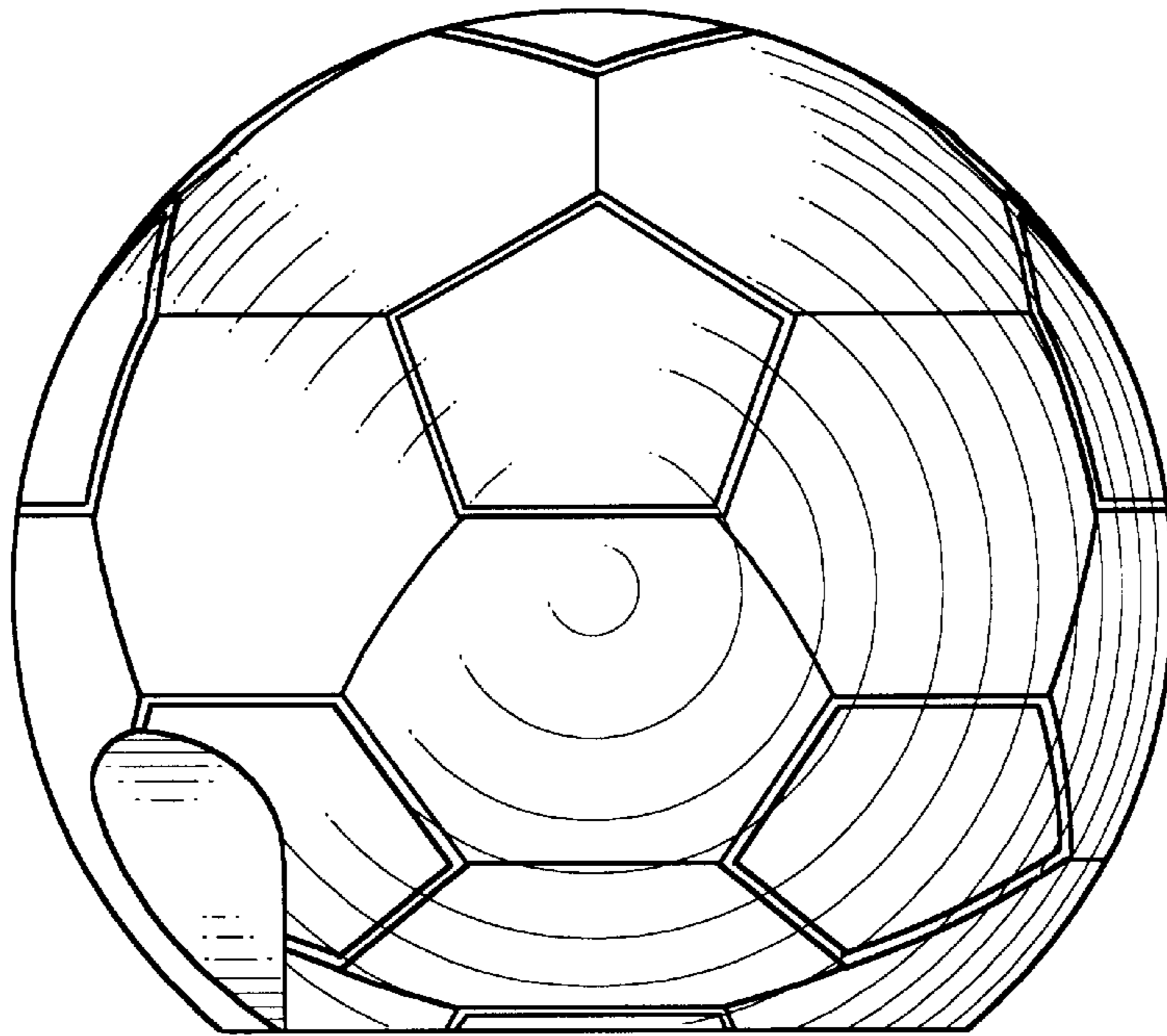

Fig. 6

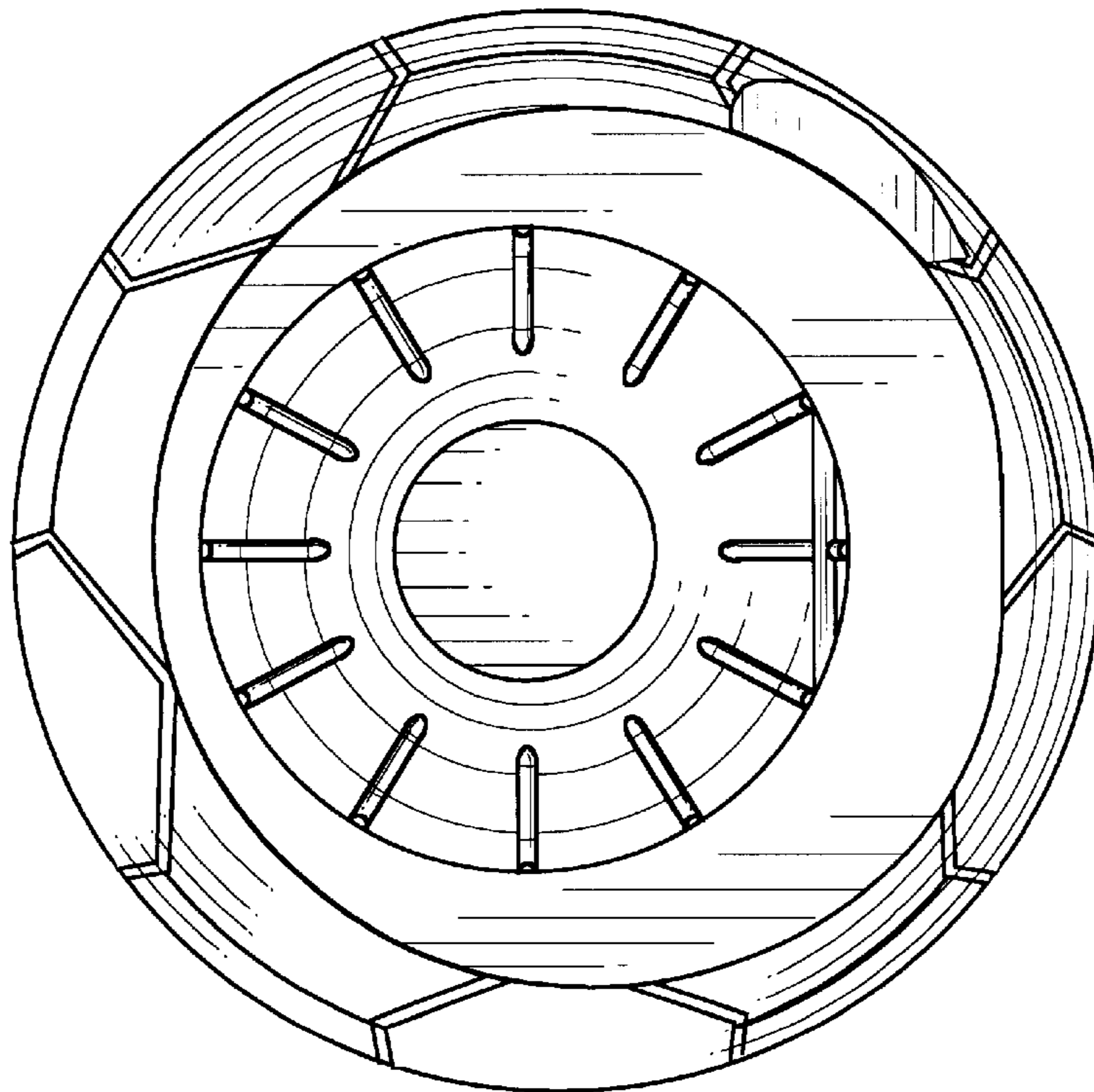

Fig. 7