



US00D409479S

United States Patent [19]
Beugelsdyk et al.

[11] **Patent Number: Des. 409,479**
[45] **Date of Patent: ** May 11, 1999**

[54] **CONDUIT GUIDE CLIP**

5,615,583 4/1997 Cunningham et al. .
5,632,182 5/1997 Reasoner .
5,634,379 6/1997 Barnard .

[75] Inventors: **Anthony F. Beugelsdyk; Michael A. Barnard; Marvin L. Cox**, all of Wichita, Kans.

OTHER PUBLICATIONS

Wescon Products Company binder—1978 (11 pgs).

[73] Assignee: **Wescon Products Company**, Wichita, Kans.

Primary Examiner—Holly Baynham
Attorney, Agent, or Firm—Hovey, Williams, Timmons & Collins

[**] Term: **14 Years**

[21] Appl. No.: **29/079,290**

[57] **CLAIM**

[22] Filed: **Nov. 12, 1997**

The ornamental design for a conduit guide clip, as shown and described.

[51] **LOC (6) Cl.** **08-08**

[52] **U.S. Cl.** **D8/395**

[58] **Field of Search** D8/394–396, 356; 248/229, 681, 74.1–74.4; 24/339, 336

DESCRIPTION

FIG. 1 is a perspective view of a conduit guide clip showing the first embodiment of our new design; FIG. 2 is an end elevational view thereof; FIG. 3 is an opposite end elevational view thereof; FIG. 4 is a side elevational view thereof; FIG. 5 is an opposition side elevational view thereof; FIG. 6 is a bottom plan view thereof; FIG. 7 is a top plan view thereof; FIG. 8 is a perspective view of a conduit guide clip showing a second embodiment of our new design; FIG. 9 is an end elevational view thereof; FIG. 10 is an opposition end elevational thereof; FIG. 11 is a side elevational view thereof; FIG. 12 is an opposite side elevational view thereof; FIG. 13 is a bottom plan view thereof; and, FIG. 14 is a top plan view thereof.

[56] **References Cited**

U.S. PATENT DOCUMENTS

1,296,042	3/1919	Bralove .	
2,655,703	10/1953	Flora	24/16 R
3,491,971	1/1970	Fisher	248/65
3,995,512	12/1976	Johnsen .	
4,011,770	3/1977	Webb .	
4,647,241	3/1987	Weber .	
5,172,878	12/1992	Lederman .	
5,230,257	7/1993	Nowak .	
5,291,910	3/1994	Bui et al. .	
5,553,822	9/1996	Barnard et al. .	
5,570,611	11/1996	Pospisil et al. .	
5,577,415	11/1996	Reasoner .	
5,579,662	12/1996	Reasoner .	
5,605,074	2/1997	Hall et al. .	

1 Claim, 1 Drawing Sheet

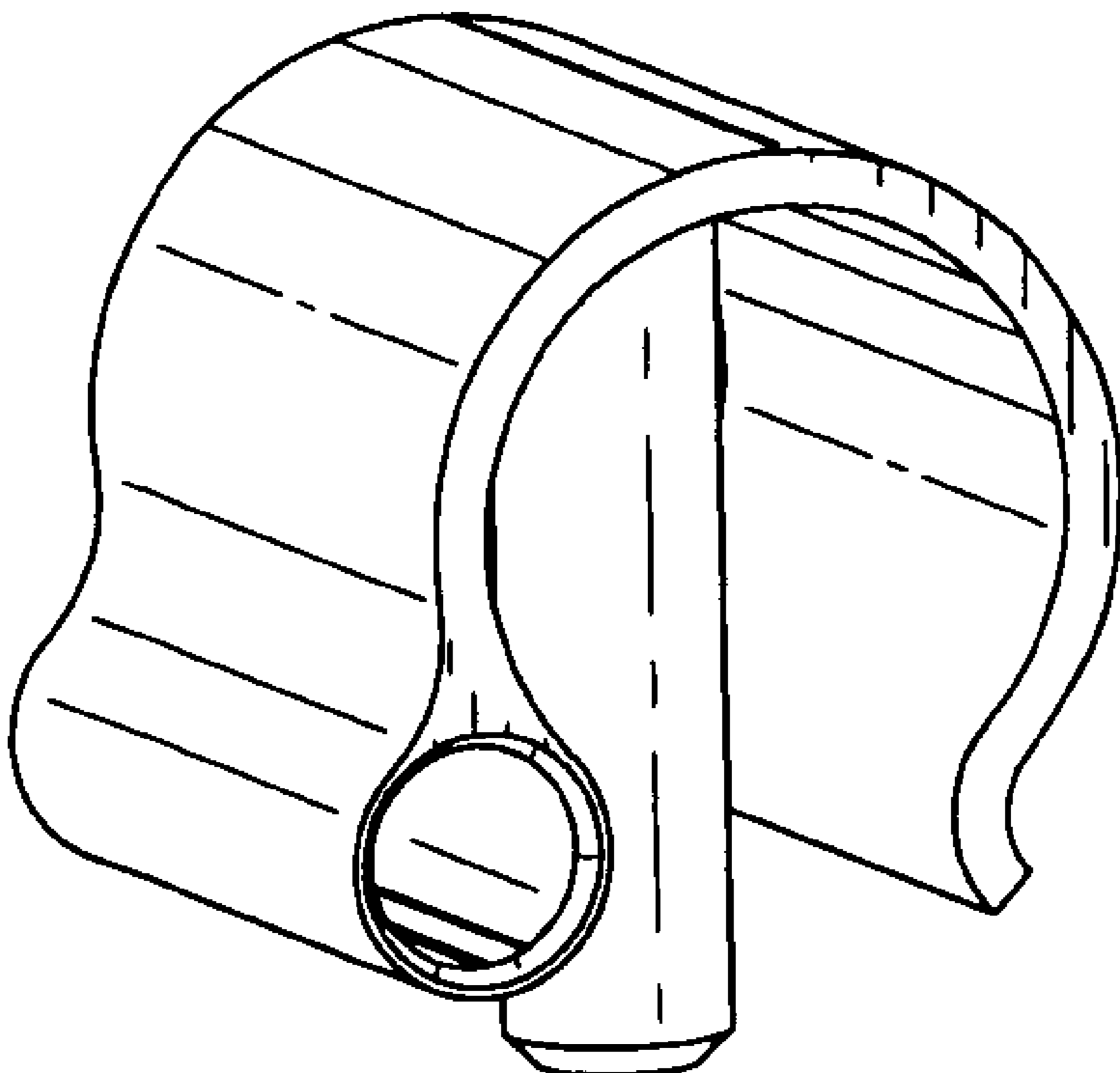

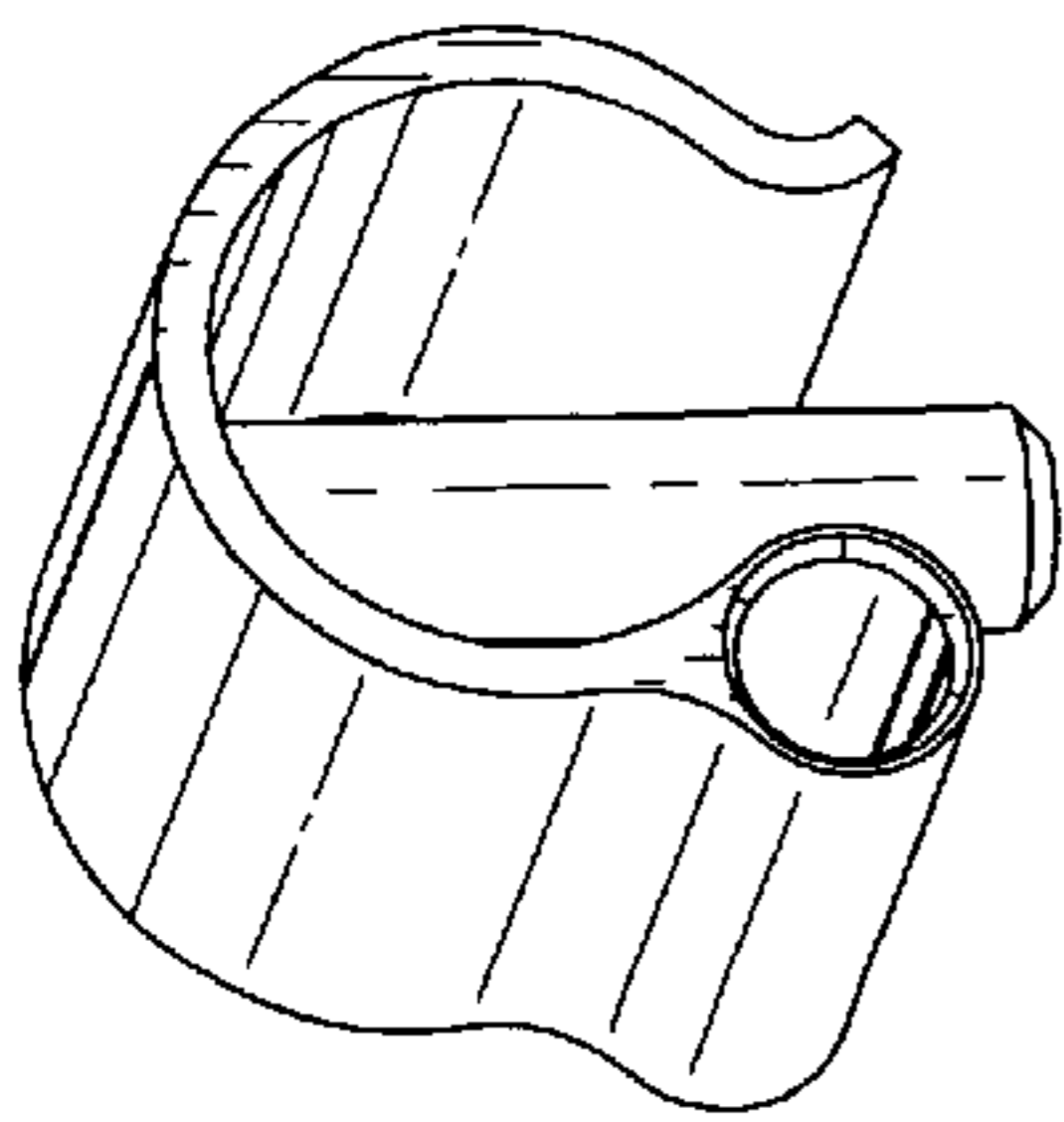

Fig. 1.

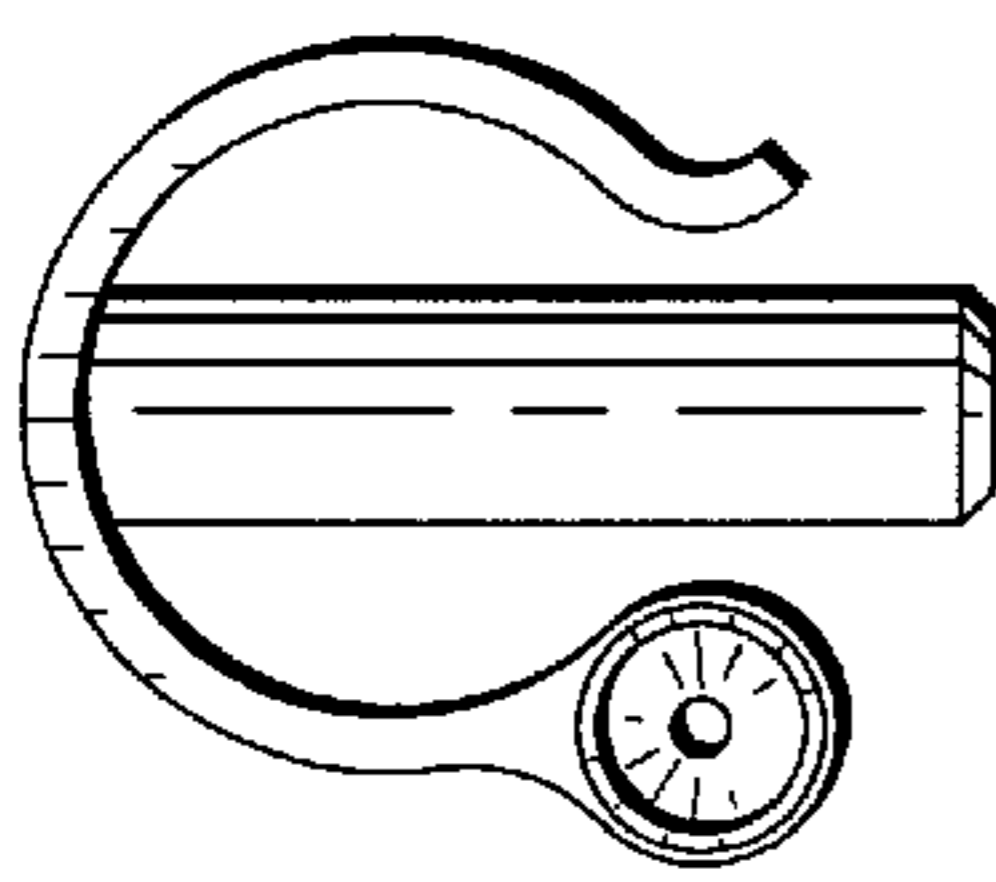

Fig. 2.

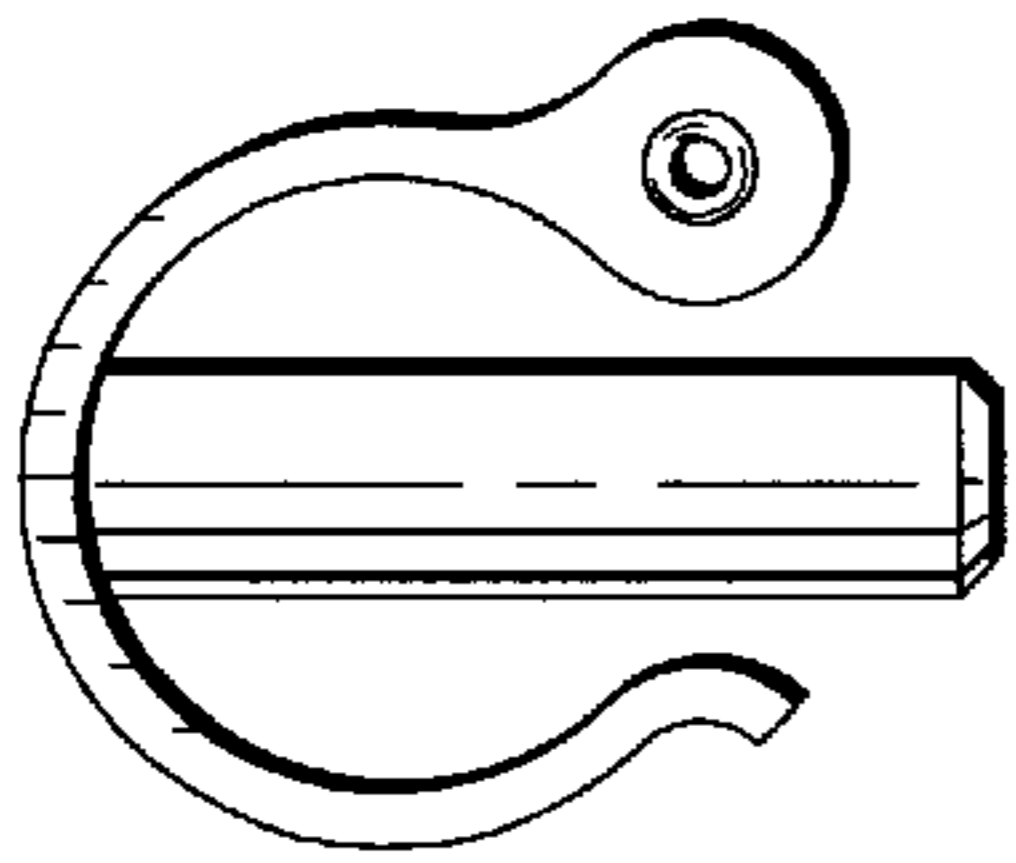

Fig. 3.

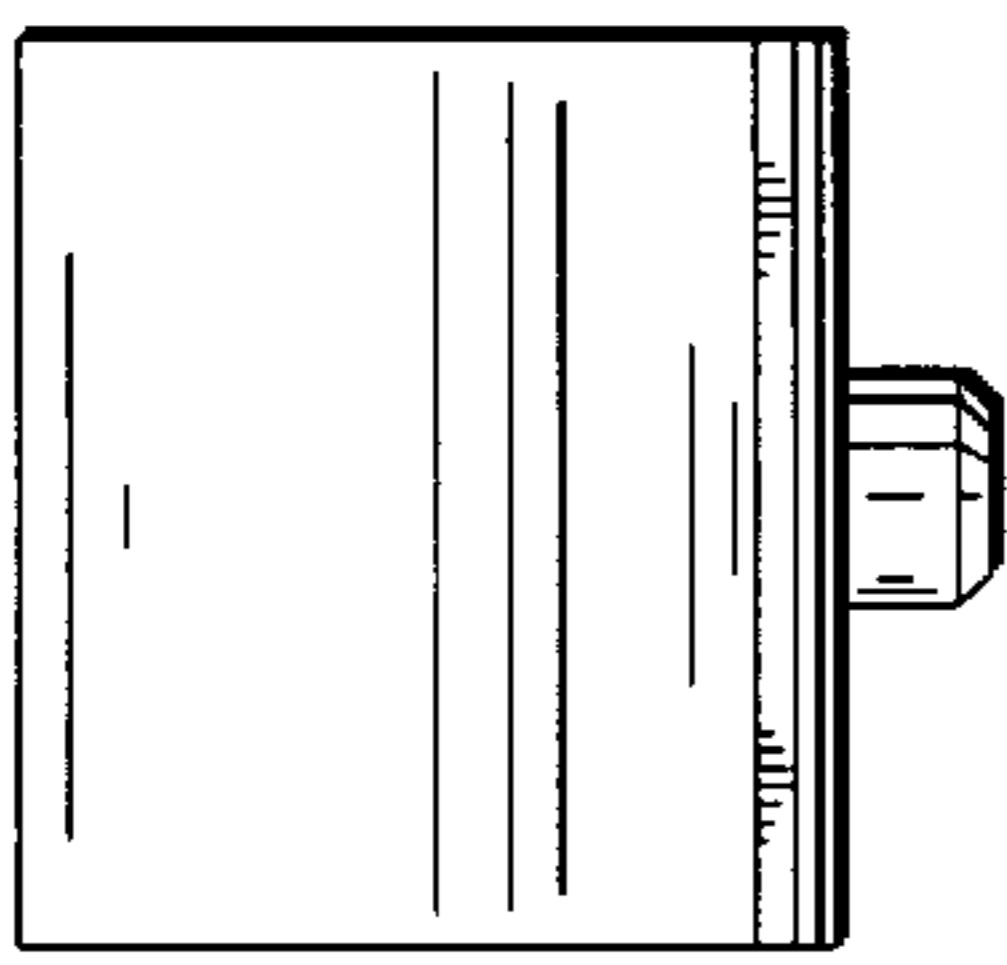

Fig. 4.

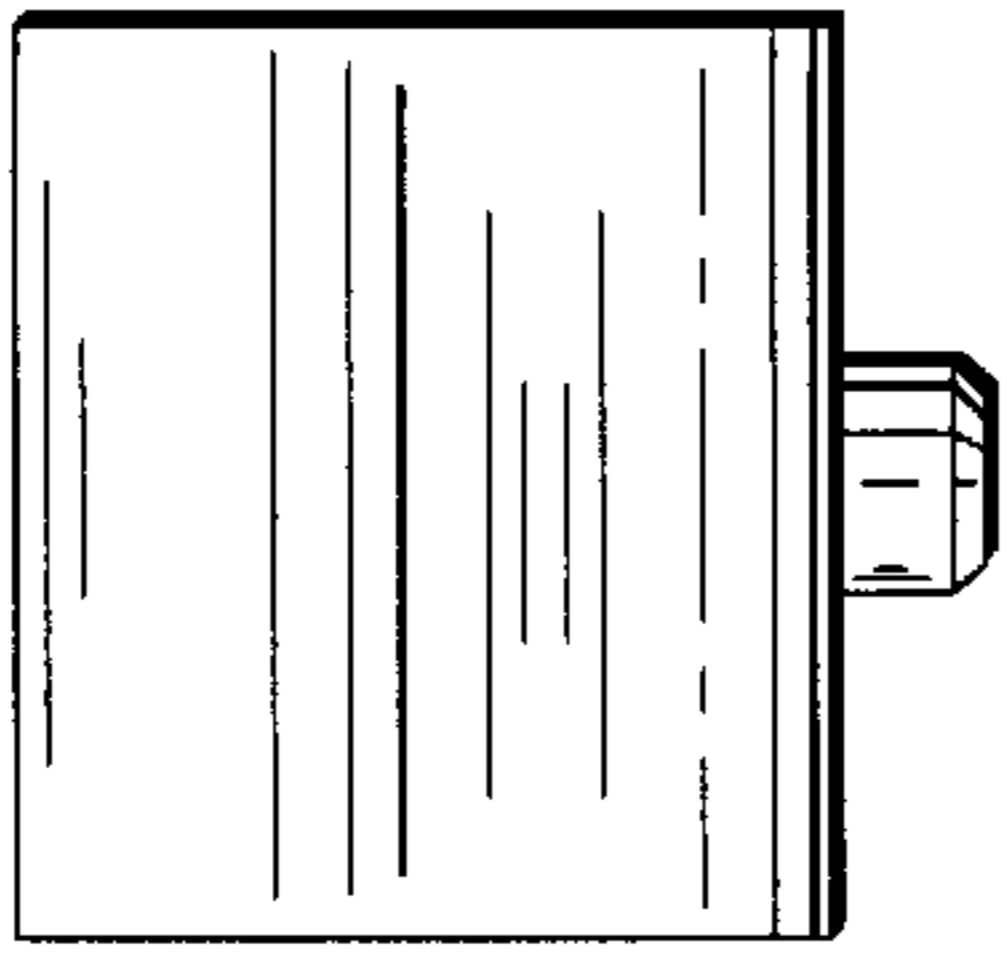

Fig. 5.

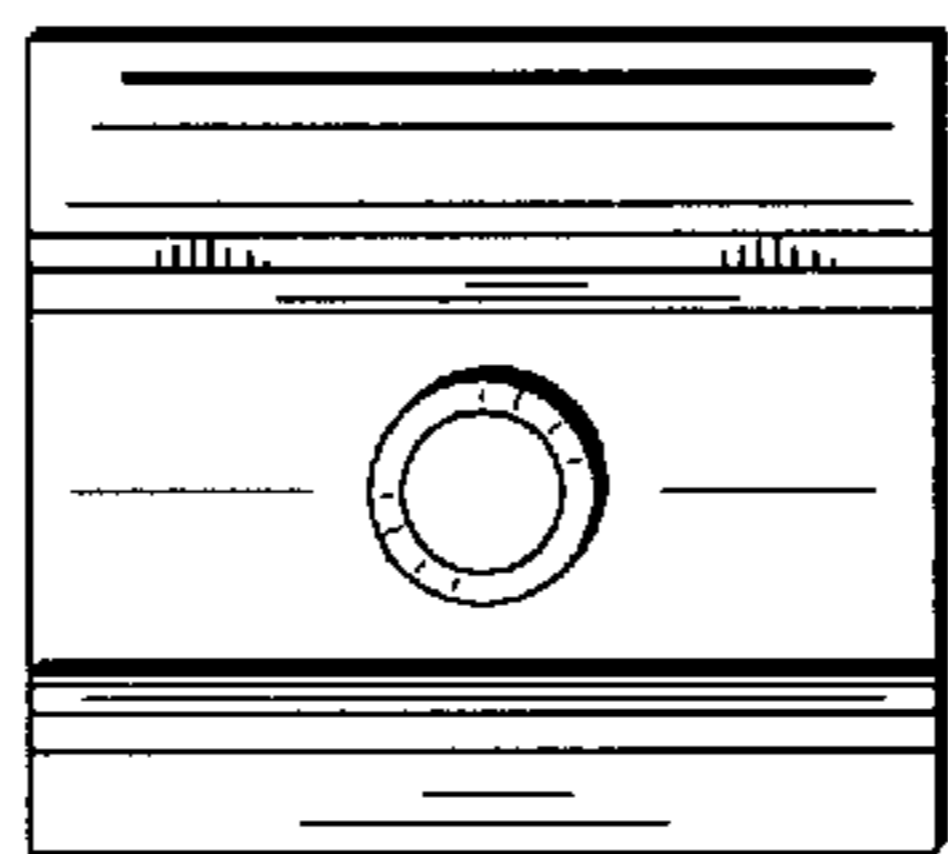

Fig. 6.

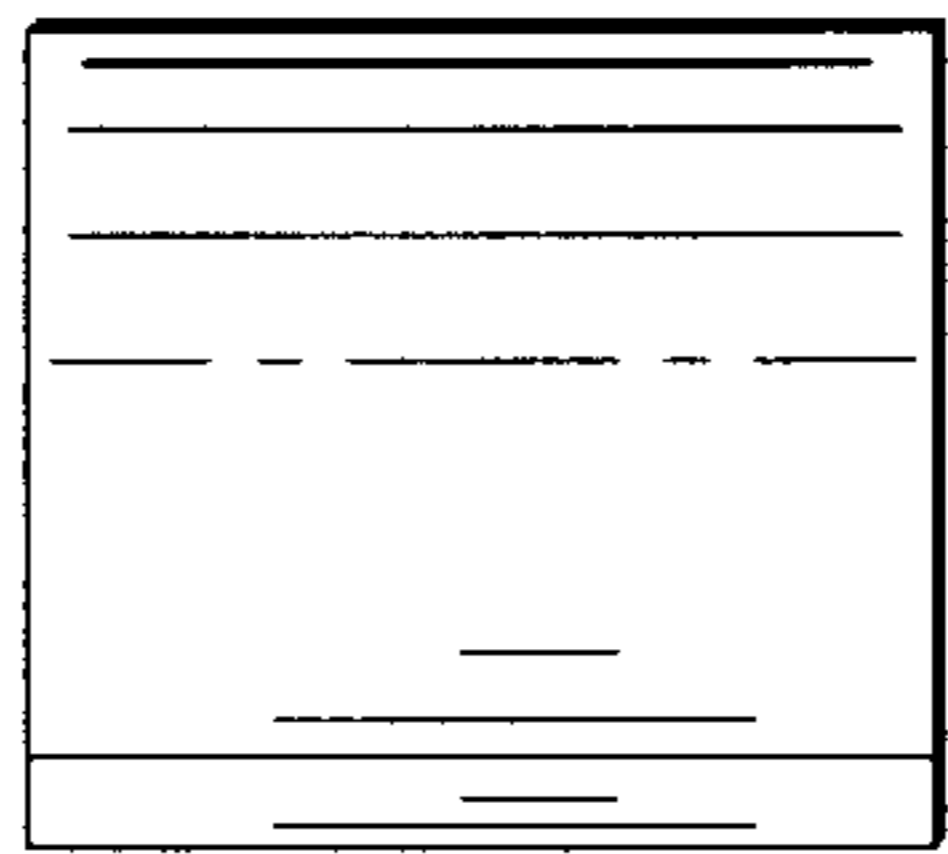

Fig. 7.

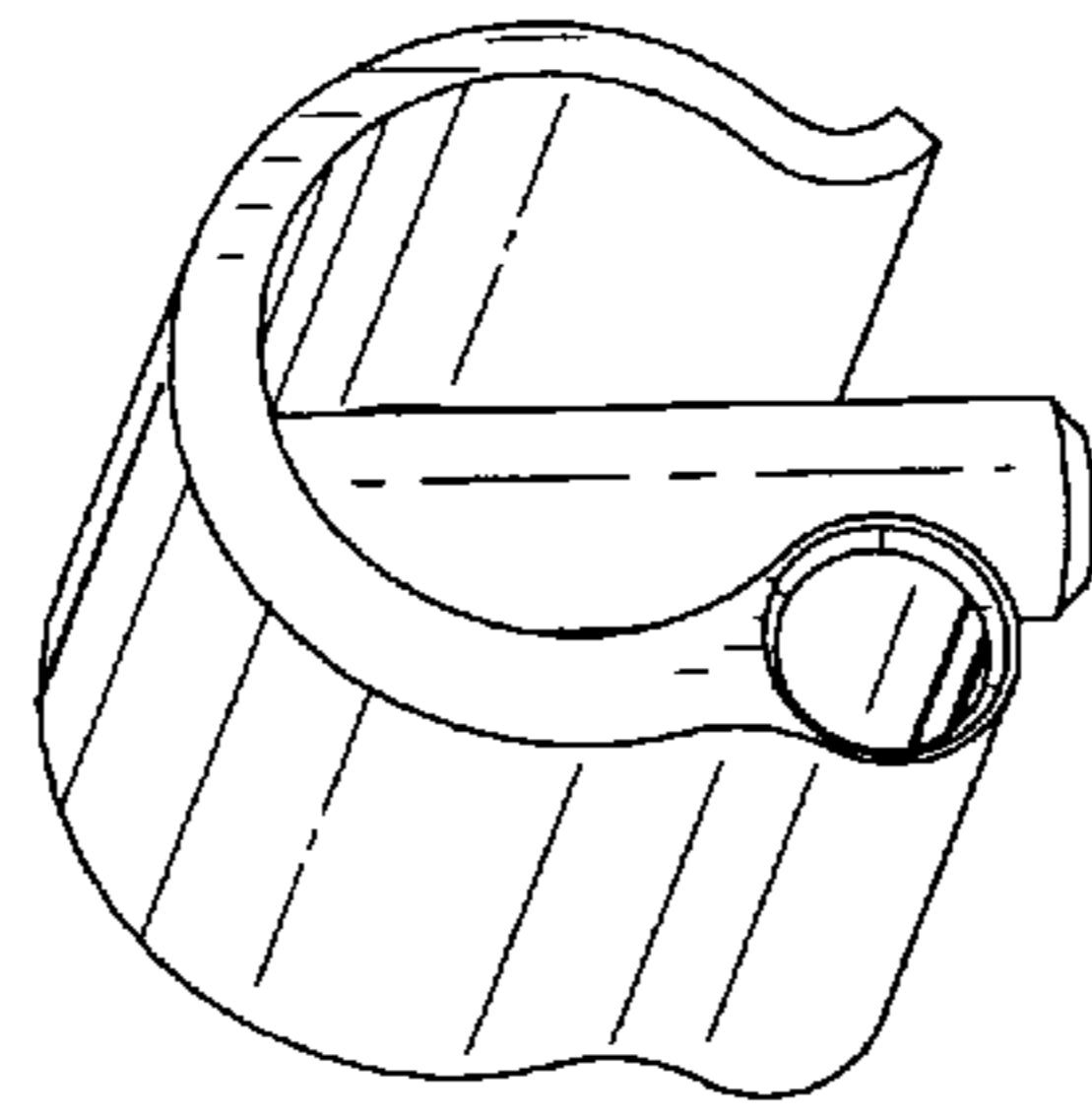

Fig. 8.

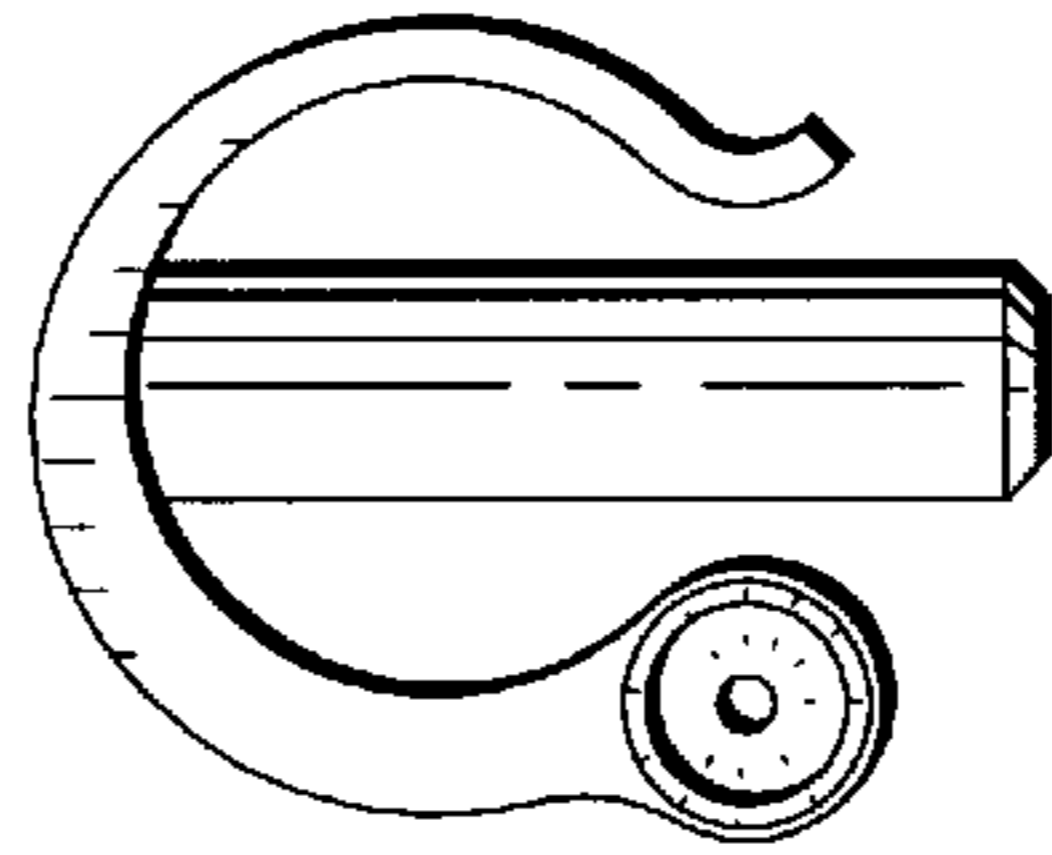

Fig. 9.

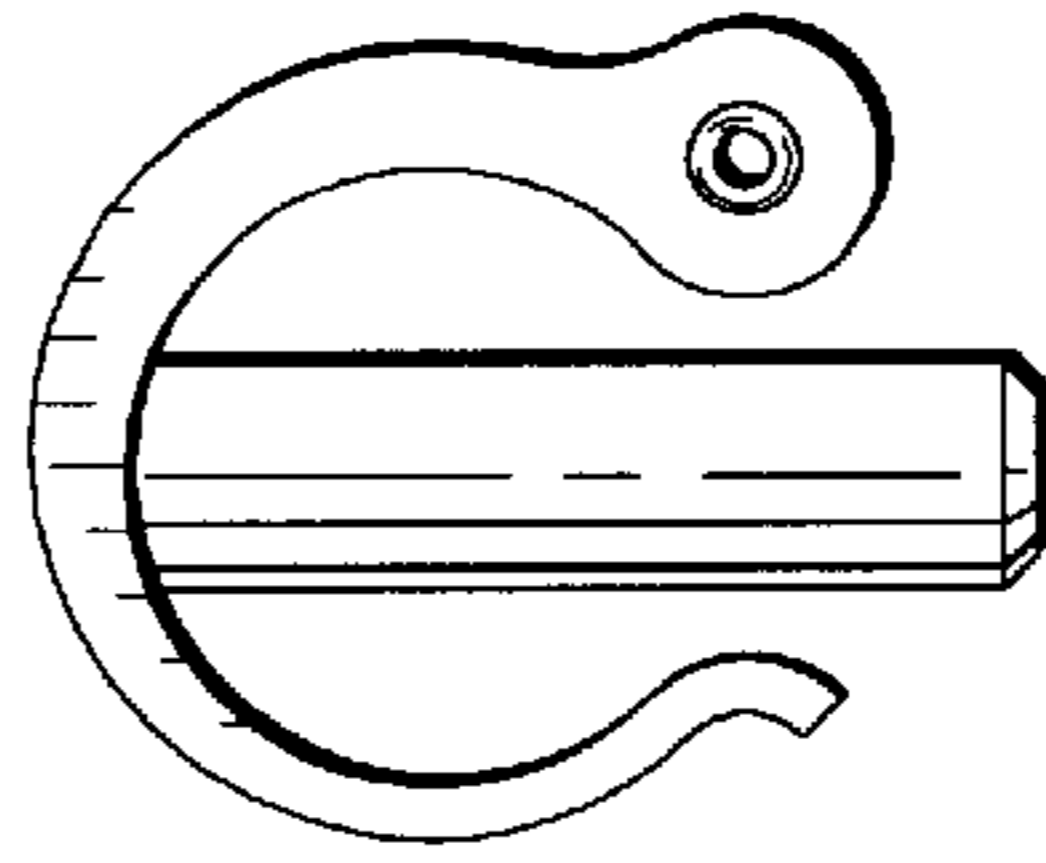

Fig. 10.

Fig. 11.

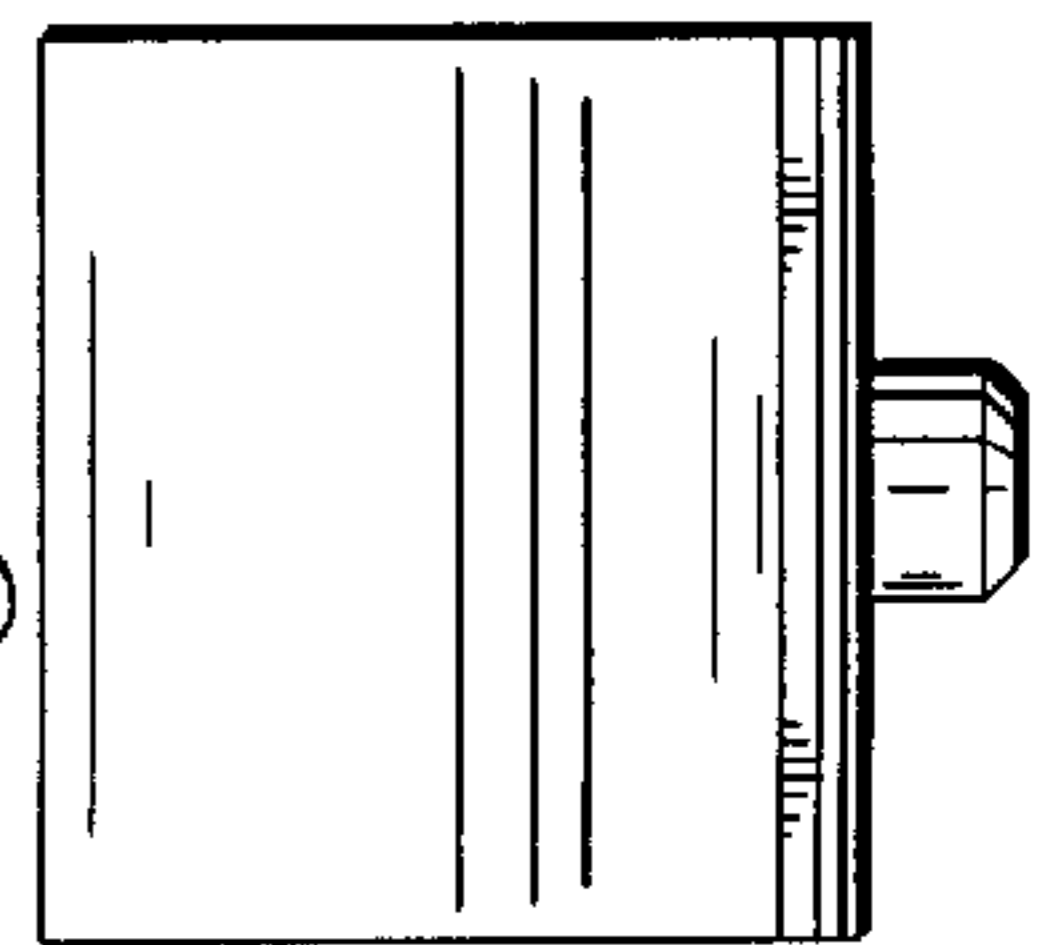

Fig. 12.

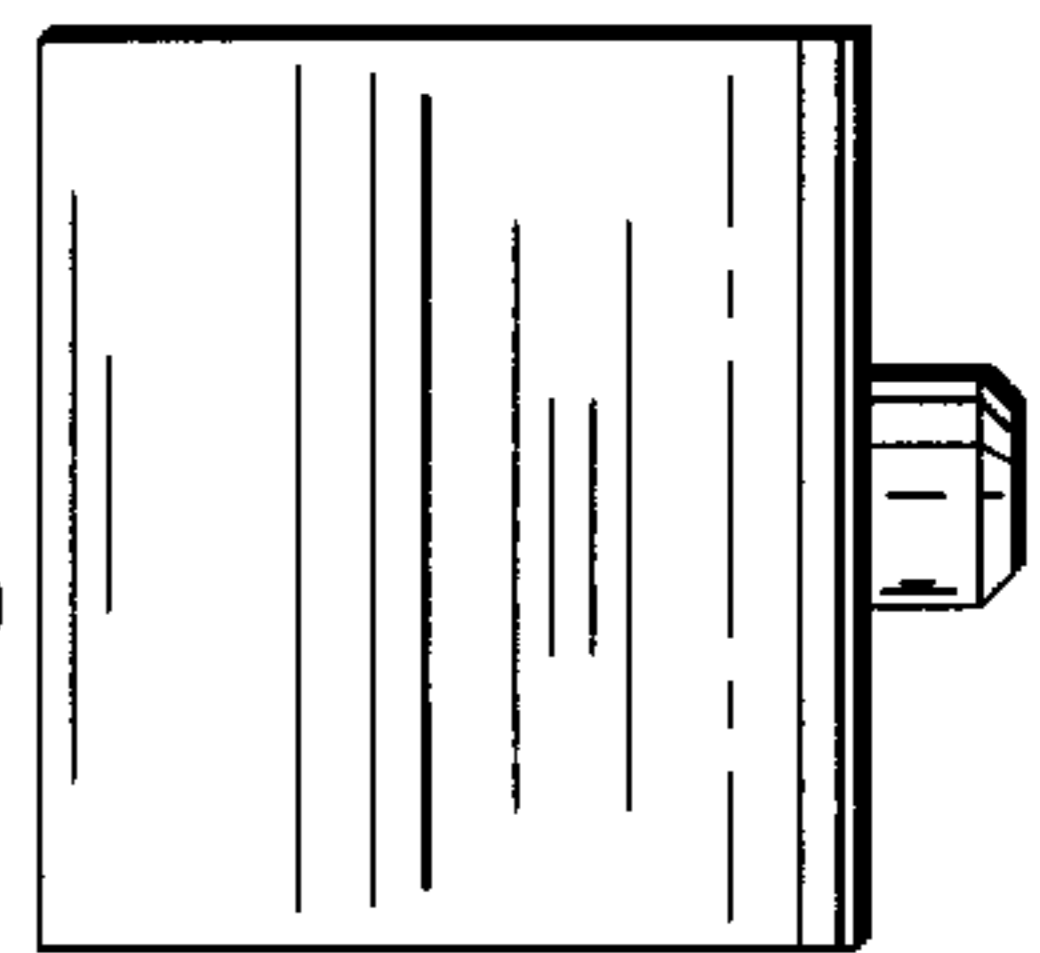

Fig. 13.

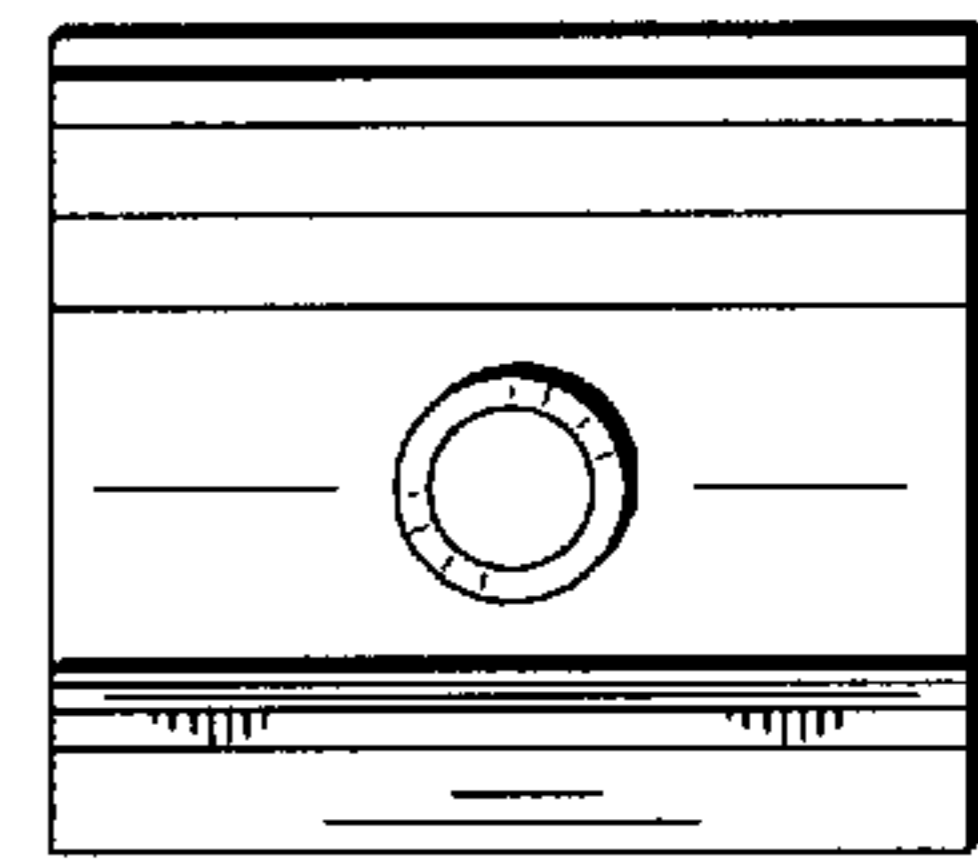

Fig. 14.

