



US00D409449S

United States Patent [19] Cornelissen

[11] **Patent Number: Des. 409,449**

[45] **Date of Patent: ** May 11, 1999**

[54] **TRAY**

[75] **Inventor: Tuur Cornelissen**, Blankenberge, Belgium

[73] **Assignee: De Ster Holding B.V.**, Amsterdam, Netherlands

[**] **Term: 14 Years**

[21] **Appl. No.: 29/089,560**

[22] **Filed: Jun. 18, 1998**

[30] **Foreign Application Priority Data**

Dec. 23, 1997 [XH] Hague Agreement DM/042829

[51] **LOC (6) Cl. 07-01**

[52] **U.S. Cl. D7/553.3; D7/553.4; D7/543; D7/545**

[58] **Field of Search D7/552.2, 554.3, D7/554.4, 545, 543, 354, 360; 206/564, 511; 270/575, 556, 23.8**

[56] **References Cited**

U.S. PATENT DOCUMENTS

- D. 193,795 10/1962 Brandon D7/554.3
- D. 223,403 4/1972 Smith D7/554.3
- D. 224,751 9/1972 Propst D7/554.3
- D. 226,284 2/1973 Bateman D7/554.3

- D. 226,285 2/1973 Bateman D7/554.3
- D. 226,673 4/1973 Bateman D7/554.3
- D. 239,316 3/1976 Smith D7/554.3
- D. 377,294 1/1997 Brady D7/554.3
- 4,265,390 5/1981 Faller et al. 206/511

Primary Examiner—M. N. Pandozzi
Attorney, Agent, or Firm—Shlesinger, Arkwright & Garvey LLP

[57] **CLAIM**

The ornamental design for the tray, as shown and described.

DESCRIPTION

FIG. 1 is a top perspective view of a tray showing my new design;
 FIG. 2 is a top view of the tray of FIG. 1;
 FIG. 3 is a front view of the tray of FIG. 1, the opposite view being a mirror image thereof;
 FIG. 4 is a bottom view of the tray of FIG. 1;
 FIG. 5 is a right side view of the tray of FIG. 1, the opposite view being a mirror image thereof;
 FIG. 6 is an enlarged view of a portion of FIG. 5 broken away for ease of illustration; and,
 FIG. 7 is an enlarged view of a portion of FIG. 3 broken away for ease of illustration;
 The broken lines are for illustrative purposes only and forms no part of the claimed design.

1 Claim, 3 Drawing Sheets

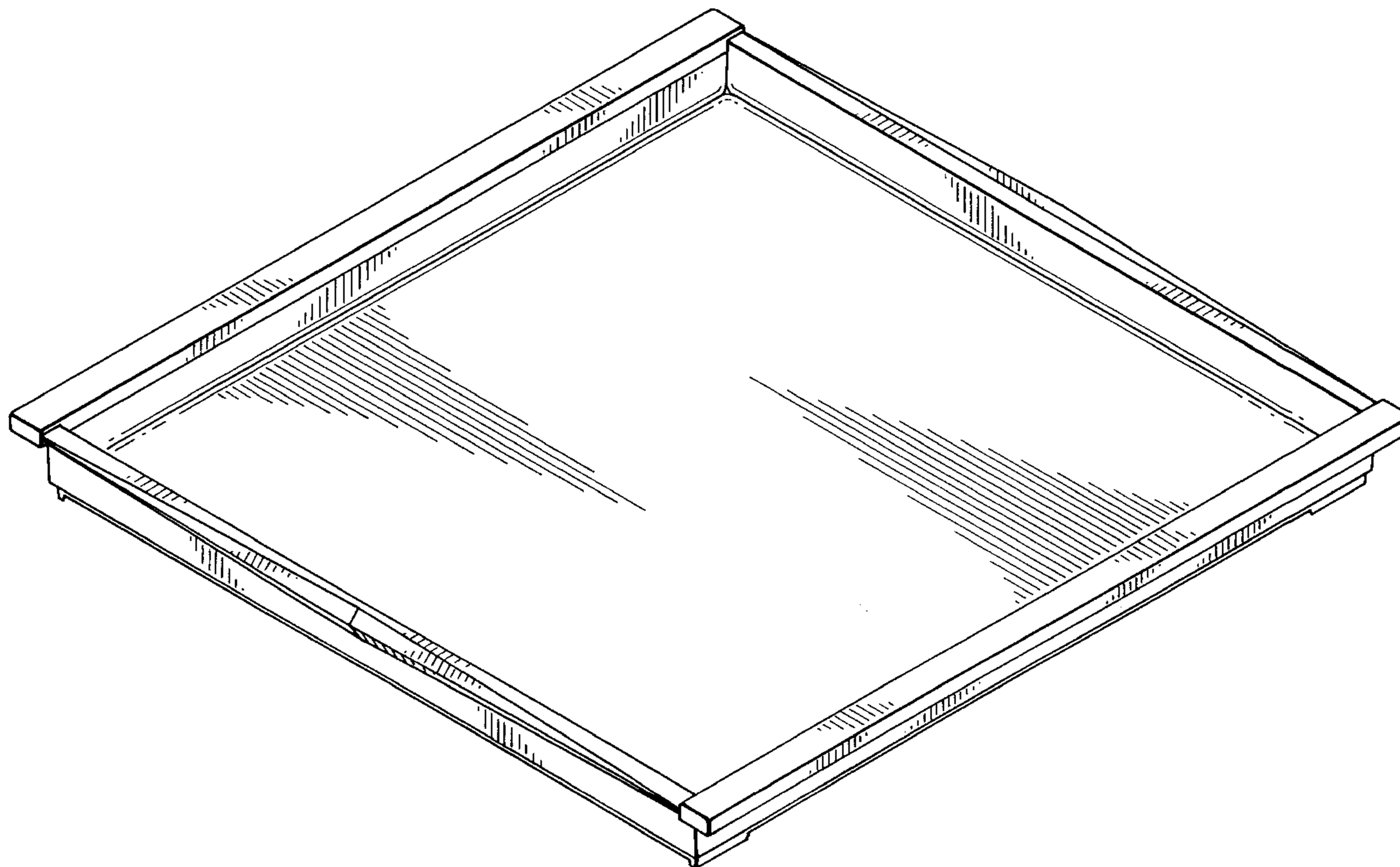

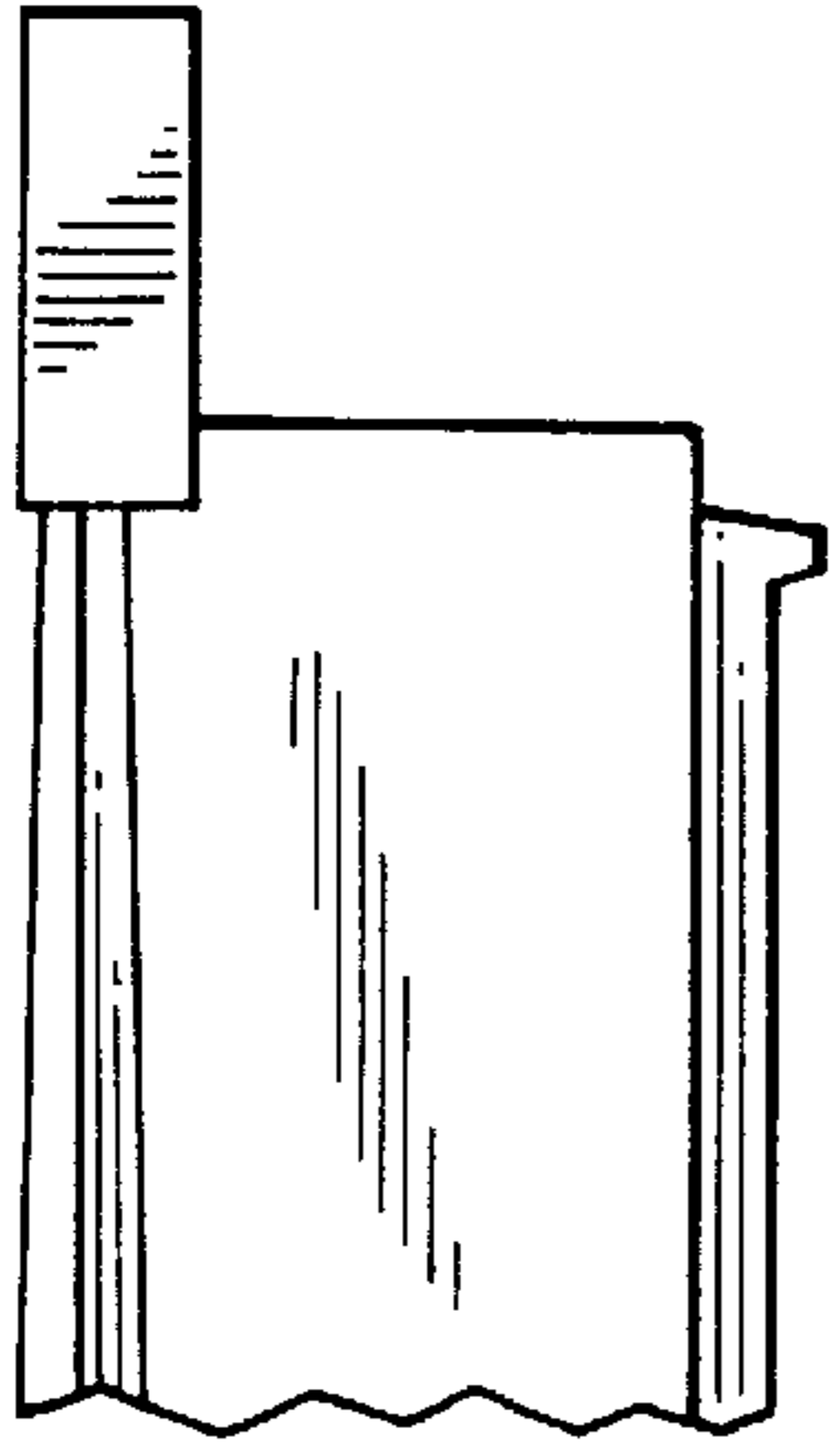

FIG. 7

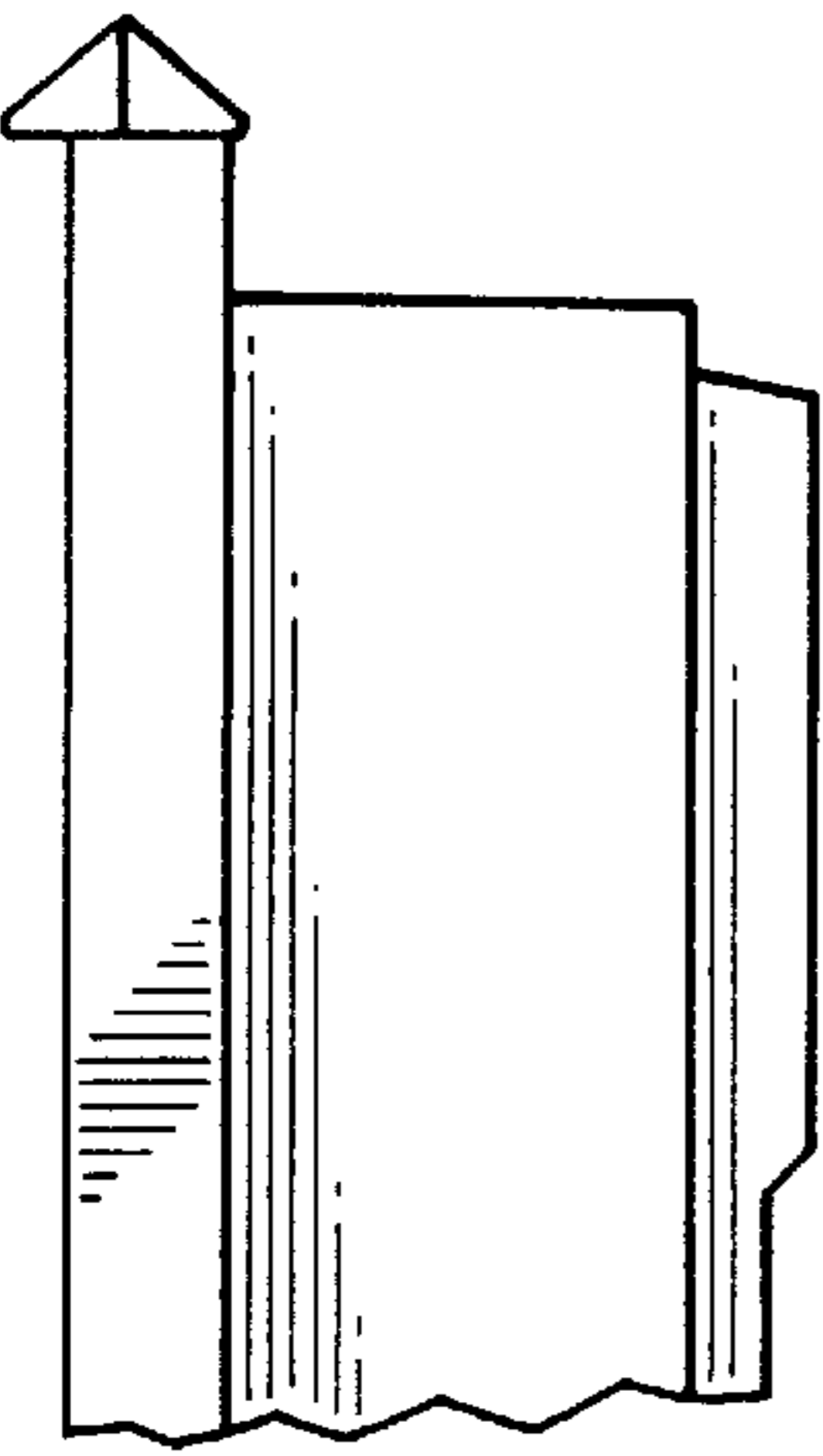

FIG. 6

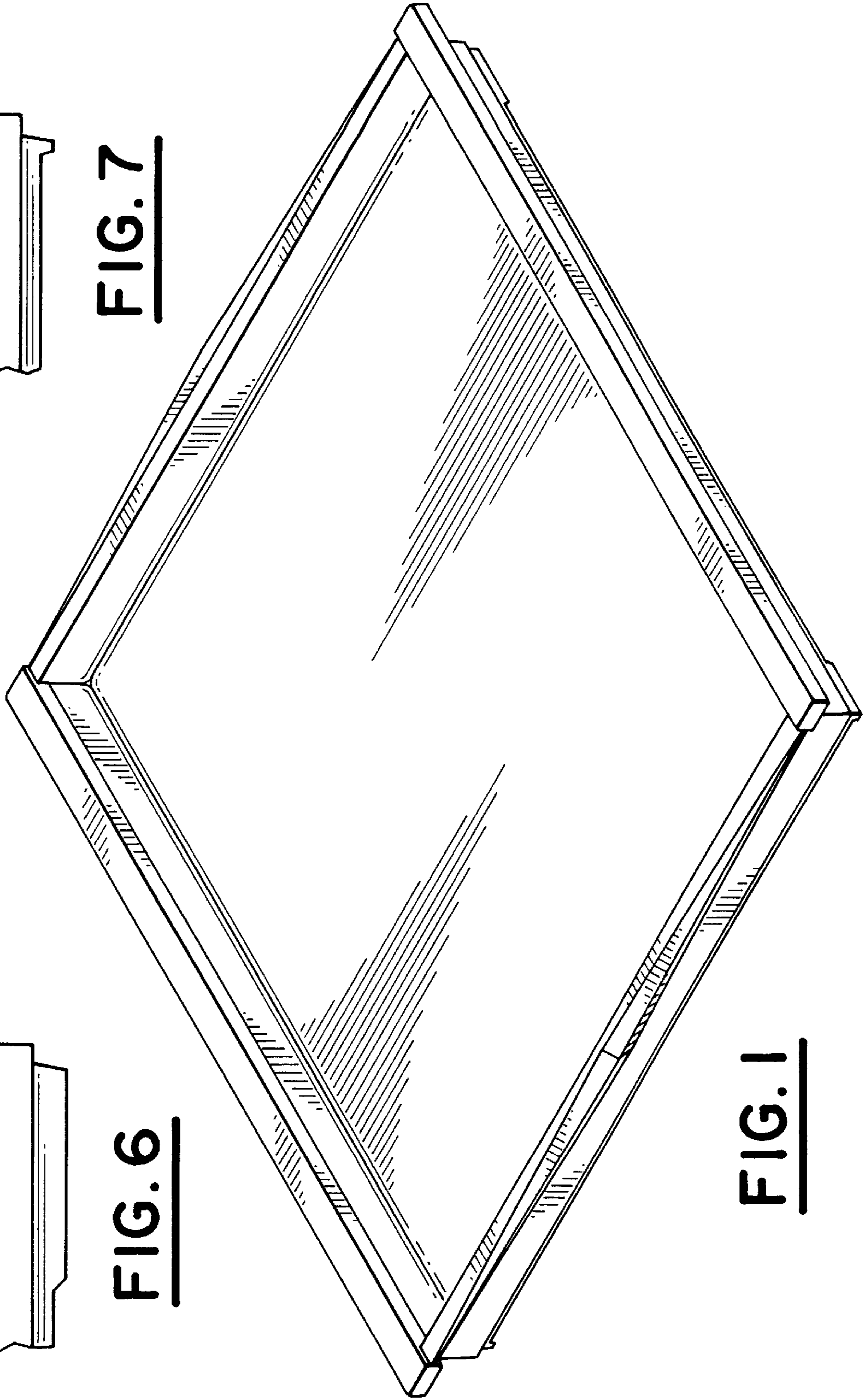

FIG. 1

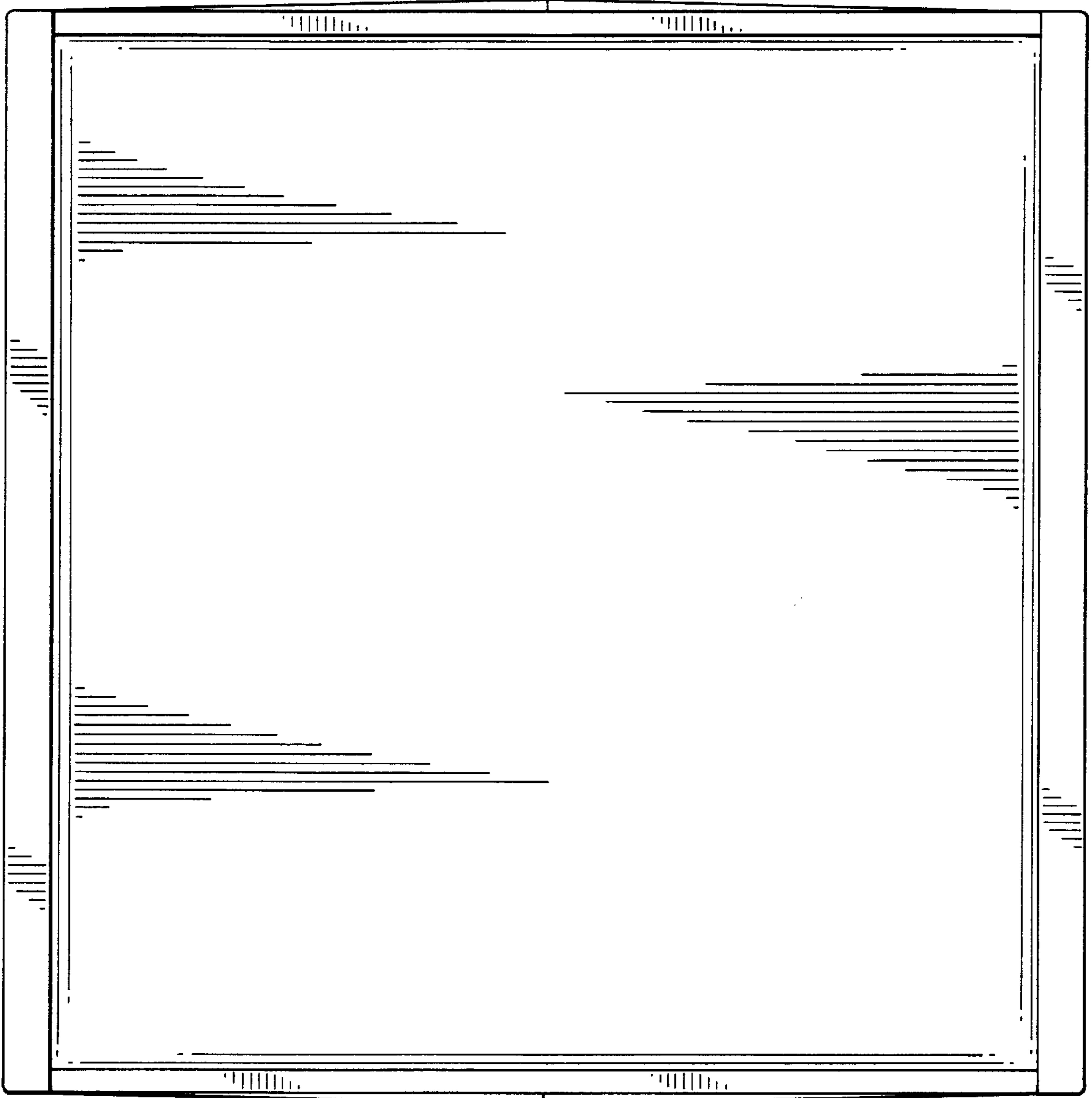

FIG. 2

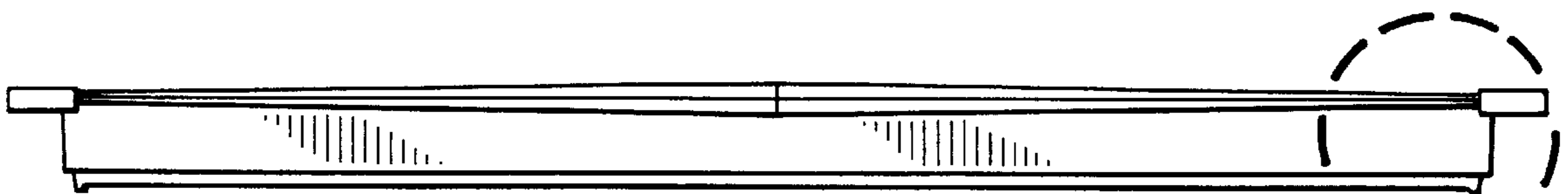

FIG. 3

FIG. 7

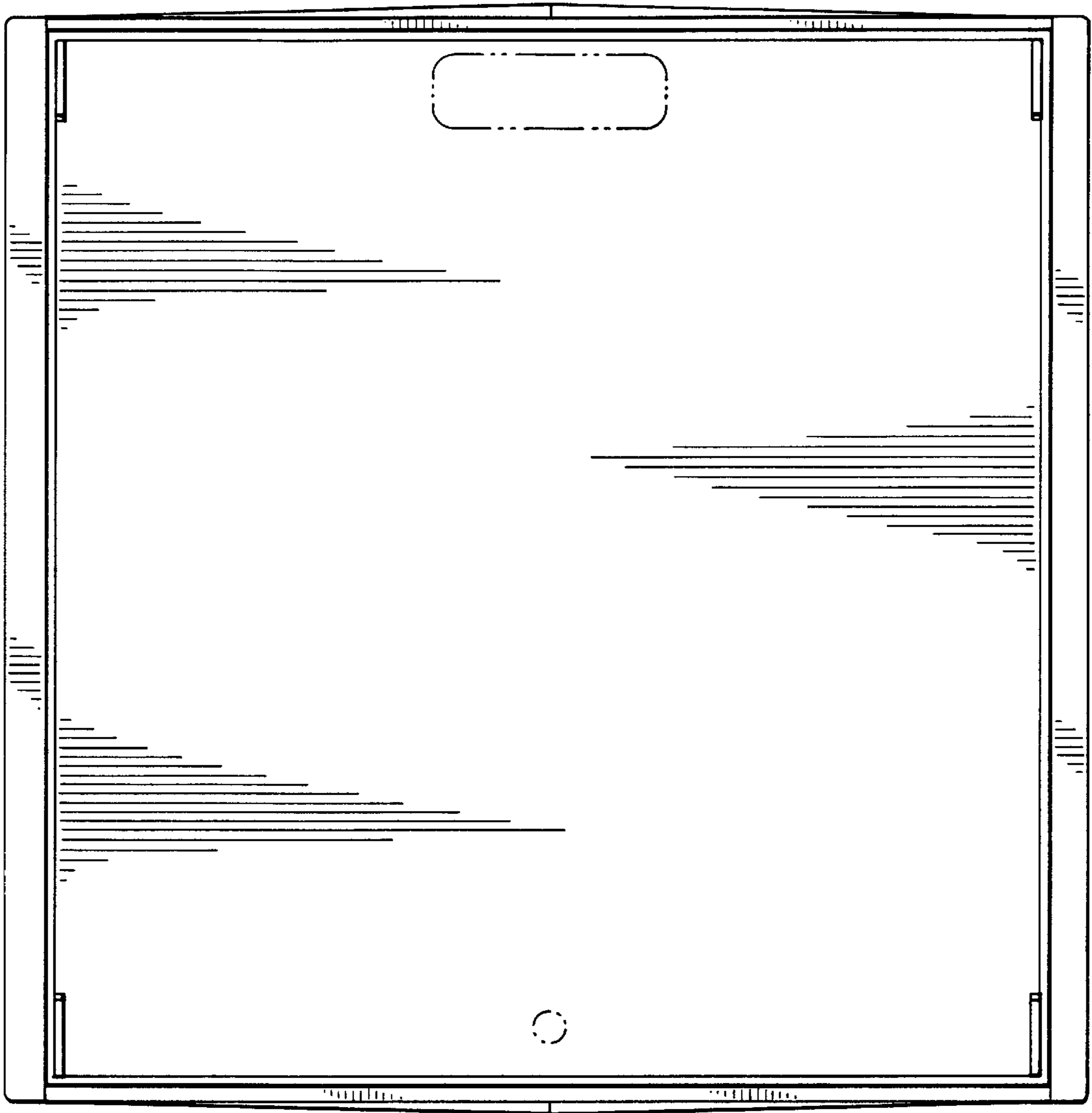

FIG. 4

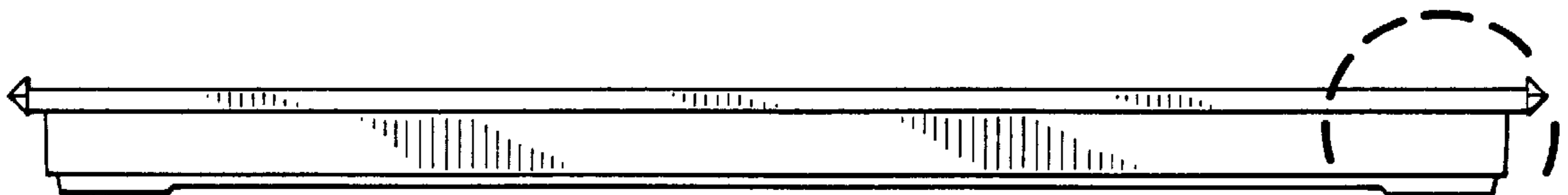

FIG. 5

FIG. 6