



US00D409434S

United States Patent [19] Gardner

[11] Patent Number: Des. 409,434

[45] Date of Patent: ** May 11, 1999

[54] **TOASTER WITH REMOVABLE CRUMB TRAY**

[76] Inventor: Anita M Gardner, 481 Urie Dr., Washington, Utah 84780

[**] Term: 14 Years

[21] Appl. No.: 29/080,817

[22] Filed: Dec. 17, 1997

[51] LOC (6) Cl. 07-02

[52] U.S. Cl. D7/330

[58] Field of Search D7/323, 328-330, D7/390; 99/372, 385, 389

[56] **References Cited**

U.S. PATENT DOCUMENTS

D. 328,002	7/1992	Gogan	D7/330
D. 328,686	8/1992	Wolfe	D7/330
2,193,972	3/1940	Lavenburg	99/327
3,866,525	2/1975	Oxel	D7/329 X

Primary Examiner—Caron D. Veynar

[57] **CLAIM**

The ornamental design for a toaster with removable crumb tray, as shown.

DESCRIPTION

FIG. 1 is a front elevational view of the toaster with removable crumb tray of the present invention; FIG. 2 is a back elevational view of the toaster with removable crumb tray of FIG. 1; FIG. 3 is a left side elevational view of the toaster with removable crumb tray of FIG. 1; FIG. 4 is a right side elevational view of the toaster with removable crumb tray of FIG. 1; FIG. 5 is a top plan view of the toaster with removable crumb tray of FIG. 1; FIG. 6 is a bottom plan view of the toaster with removable crumb tray of FIG. 1; and, FIG. 7 is an exploded top, front, right side perspective view of the toaster with removable crumb tray of FIG. 1.

1 Claim, 4 Drawing Sheets

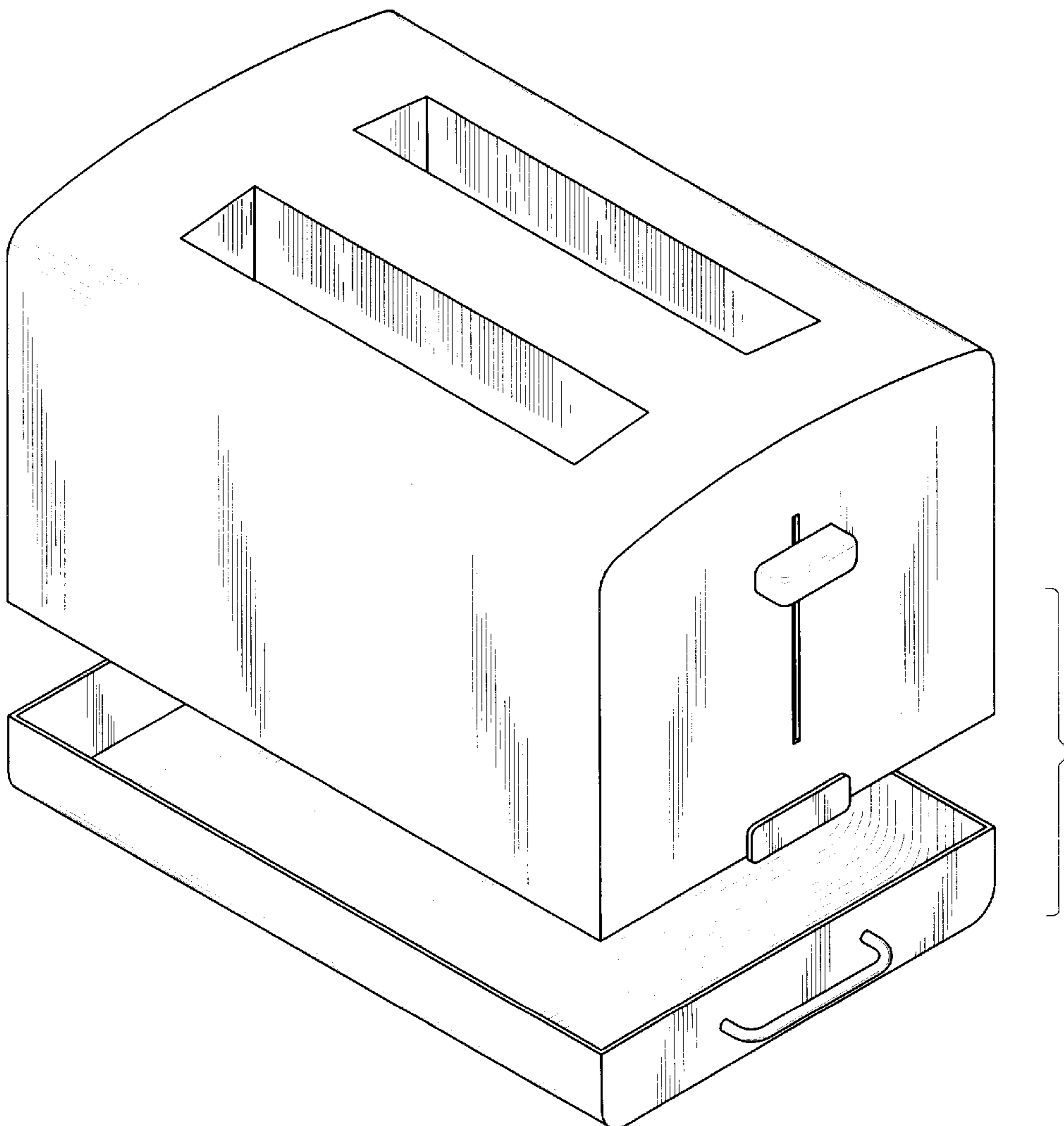

FIG. 1

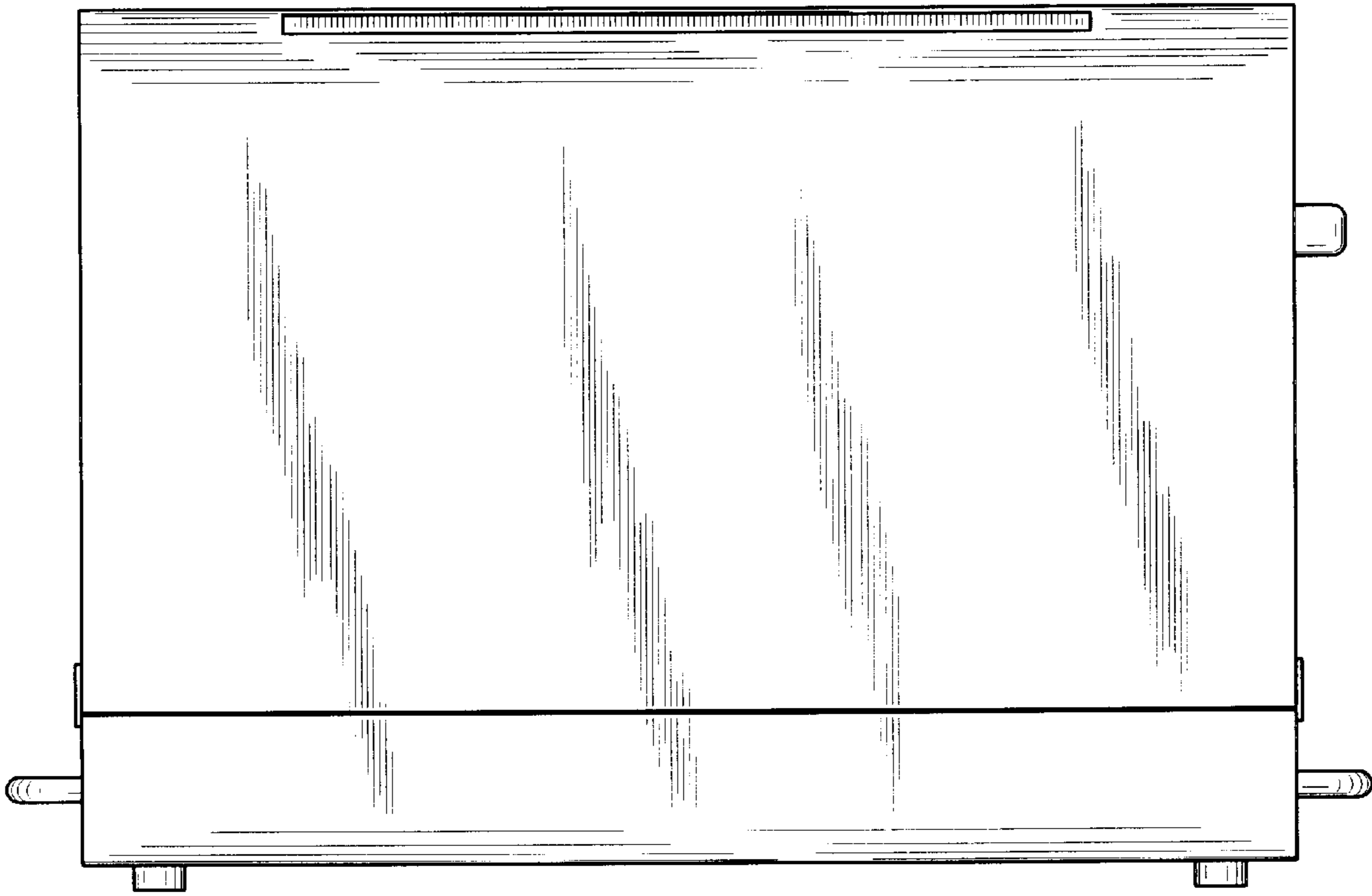

FIG. 2

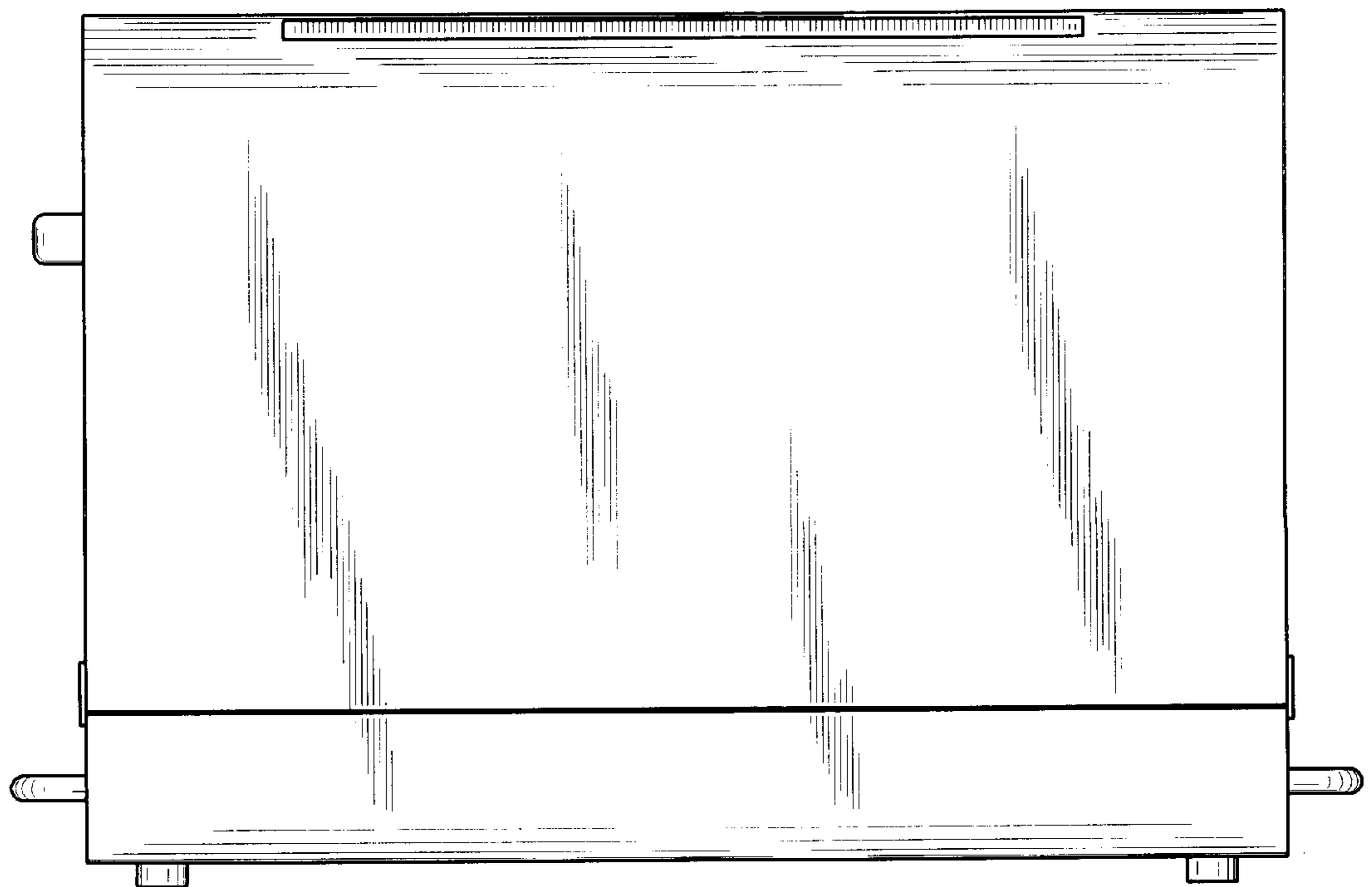

FIG. 3

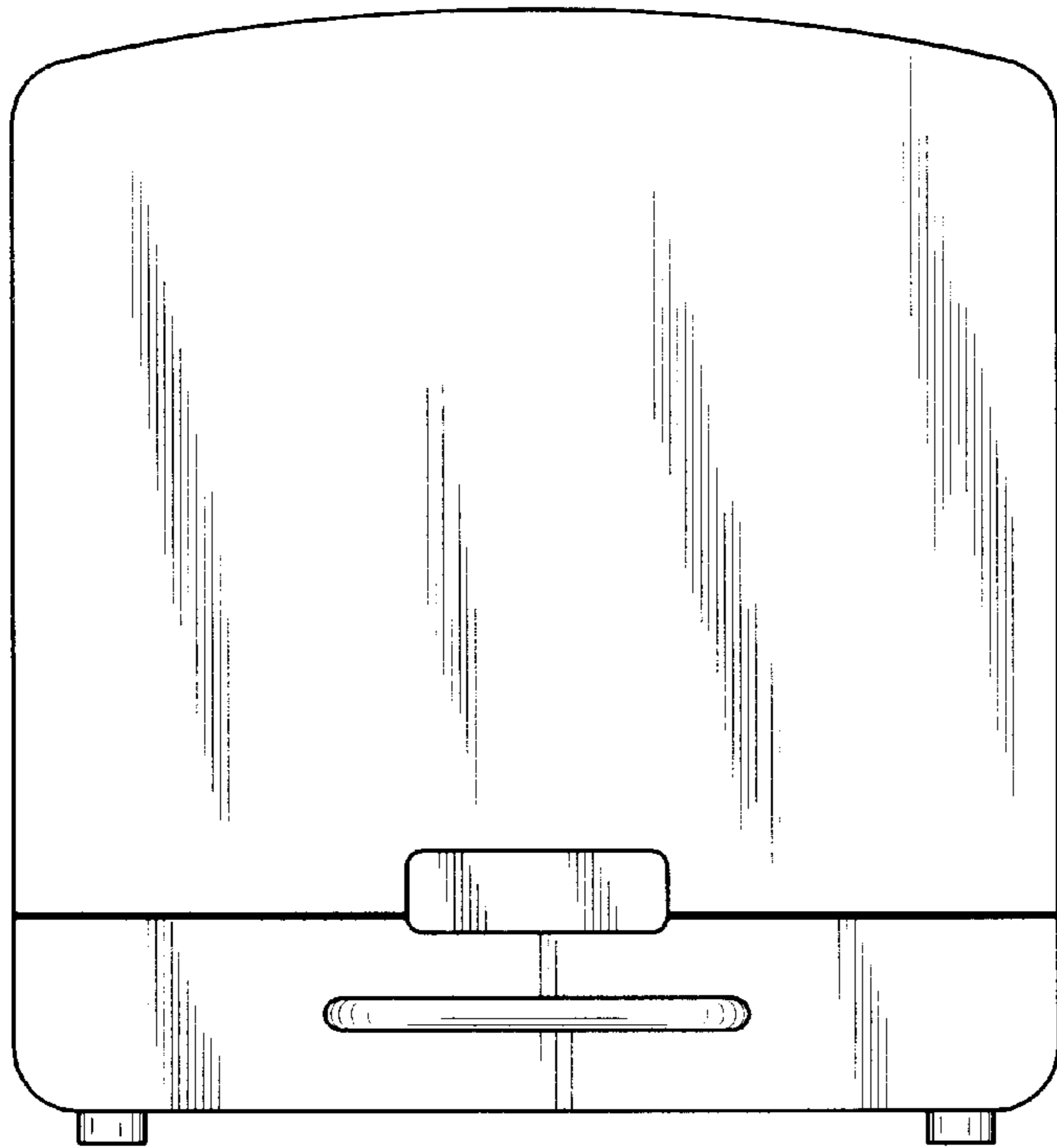

FIG. 4

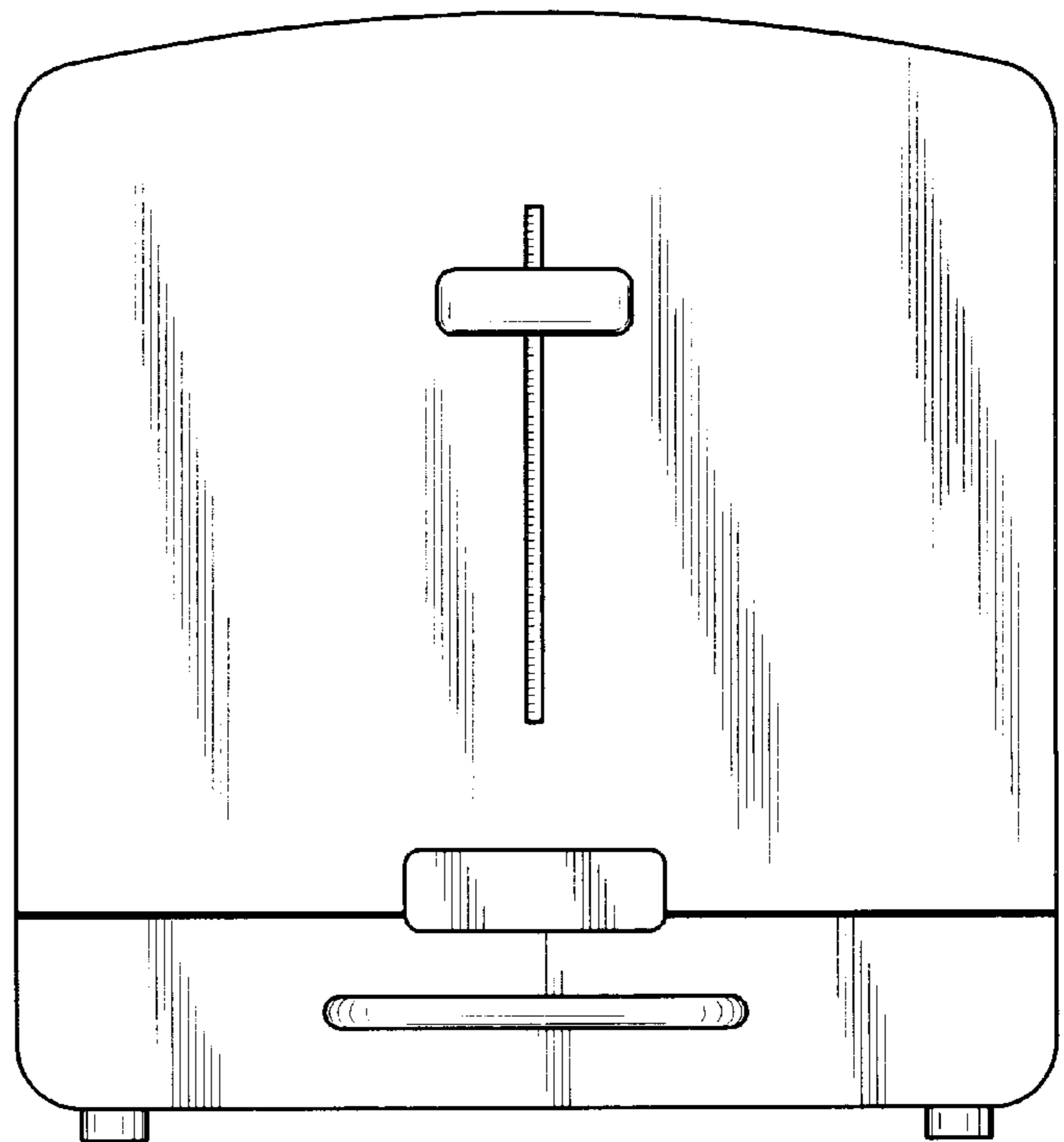

FIG. 5

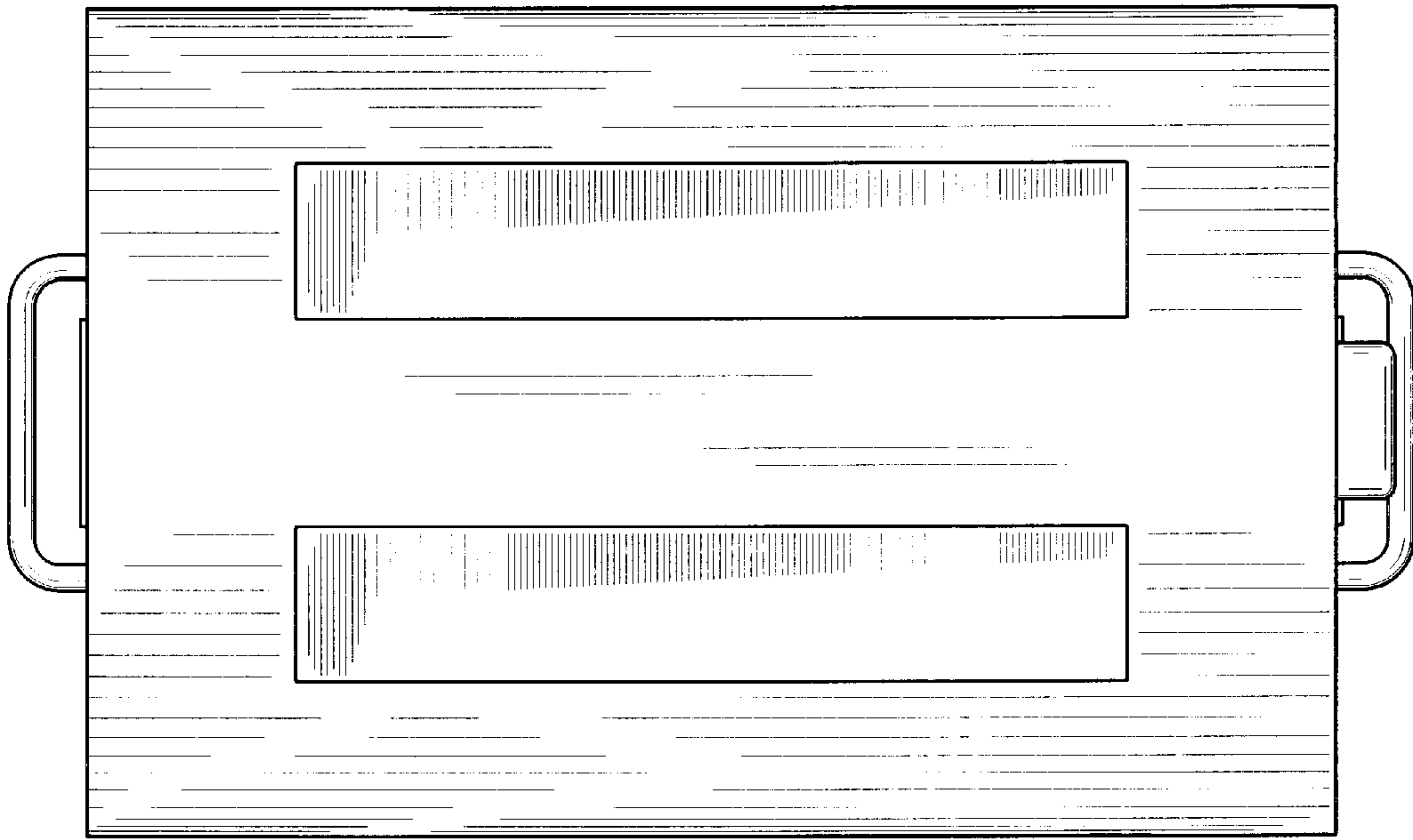

FIG. 6

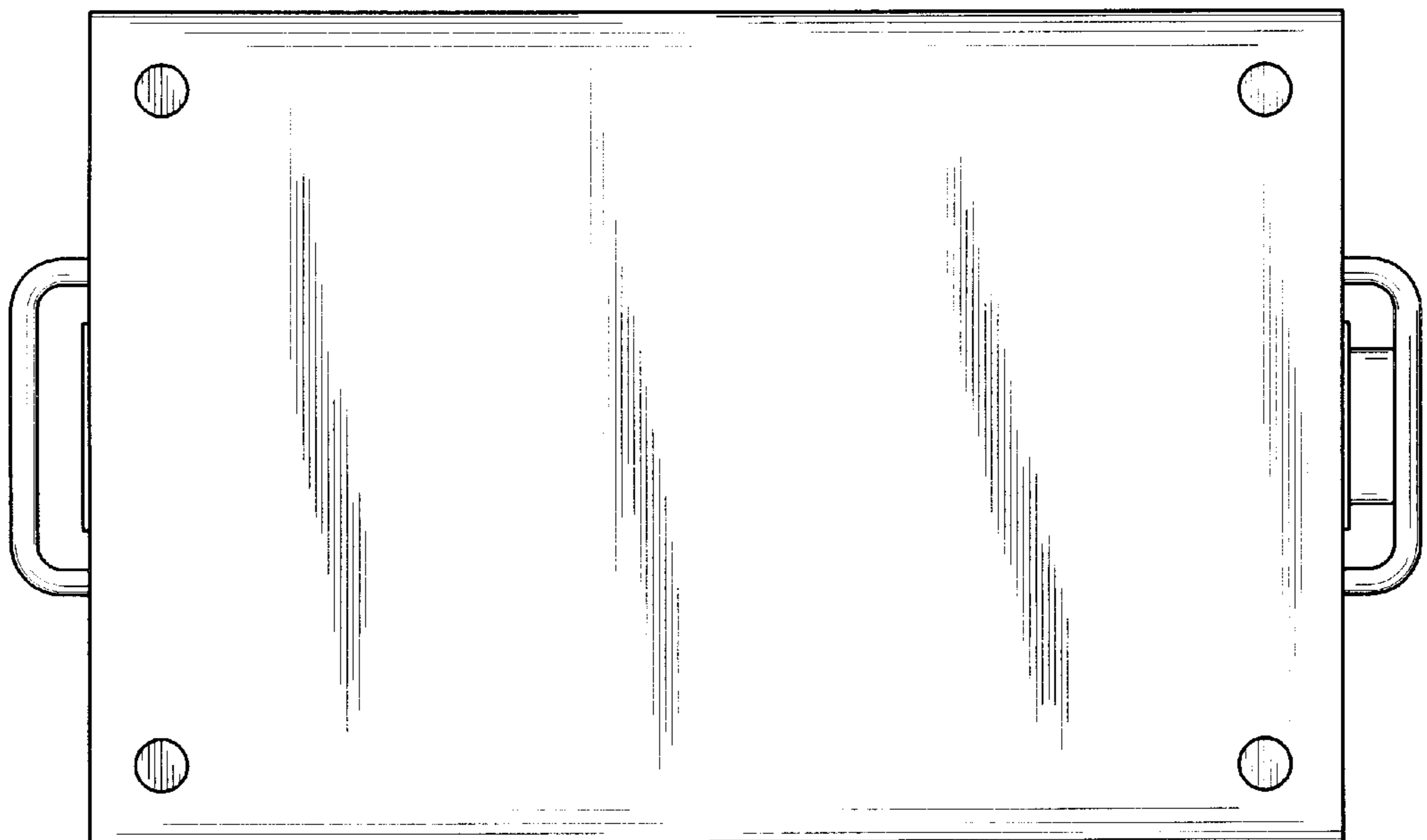

FIG. 7

