



US00D409414S

United States Patent [19]
Weiner

[11] **Patent Number: Des. 409,414**

[45] **Date of Patent: ** May 11, 1999**

[54] **PYRAMIDAL RECEPTACLE AND DISPLAY**

[75] Inventor: **Douglas S. Weiner**, Twinsburg, Ohio

[73] Assignee: **Pyramid Corporation**, Twinsburg, Ohio

[**] Term: **14 Years**

[21] Appl. No.: **29/088,499**

[22] Filed: **May 26, 1998**

[51] **LOC (6) Cl.** **06-06**

[52] **U.S. Cl.** **D6/449; D11/131**

[58] **Field of Search** **D11/131; D6/449, D6/490, 470, 471, 455, 415, 457, 310, 314, 626; 211/134, 135, 1, 13.1**

[56] **References Cited**

U.S. PATENT DOCUMENTS

D. 217,197 4/1970 Phillips D6/449
D. 237,431 11/1975 Deam D11/131

D. 247,694 4/1978 Mueh et al. D6/449
D. 276,773 12/1984 Rodriguez D6/490
D. 369,700 5/1996 Sandy D6/449 X
D. 375,421 11/1996 Weiner D6/449

Primary Examiner—Dominic Simone
Attorney, Agent, or Firm—Calfee, Halter & Griswold LLP

[57] **CLAIM**

The ornamental design for a pyramidal receptacle and display, as shown and described.

DESCRIPTION

FIG. 1 is a perspective view of a pyramidal receptacle and display showing my new design; FIG. 2 is a top plan view thereof; FIG. 3 is a bottom plan view thereof; FIG. 4 is a front elevational view thereof; FIG. 5 is a rear elevational view thereof; and, FIG. 6 is a right side elevational view thereof, the left side being a mirror image.

1 Claim, 1 Drawing Sheet

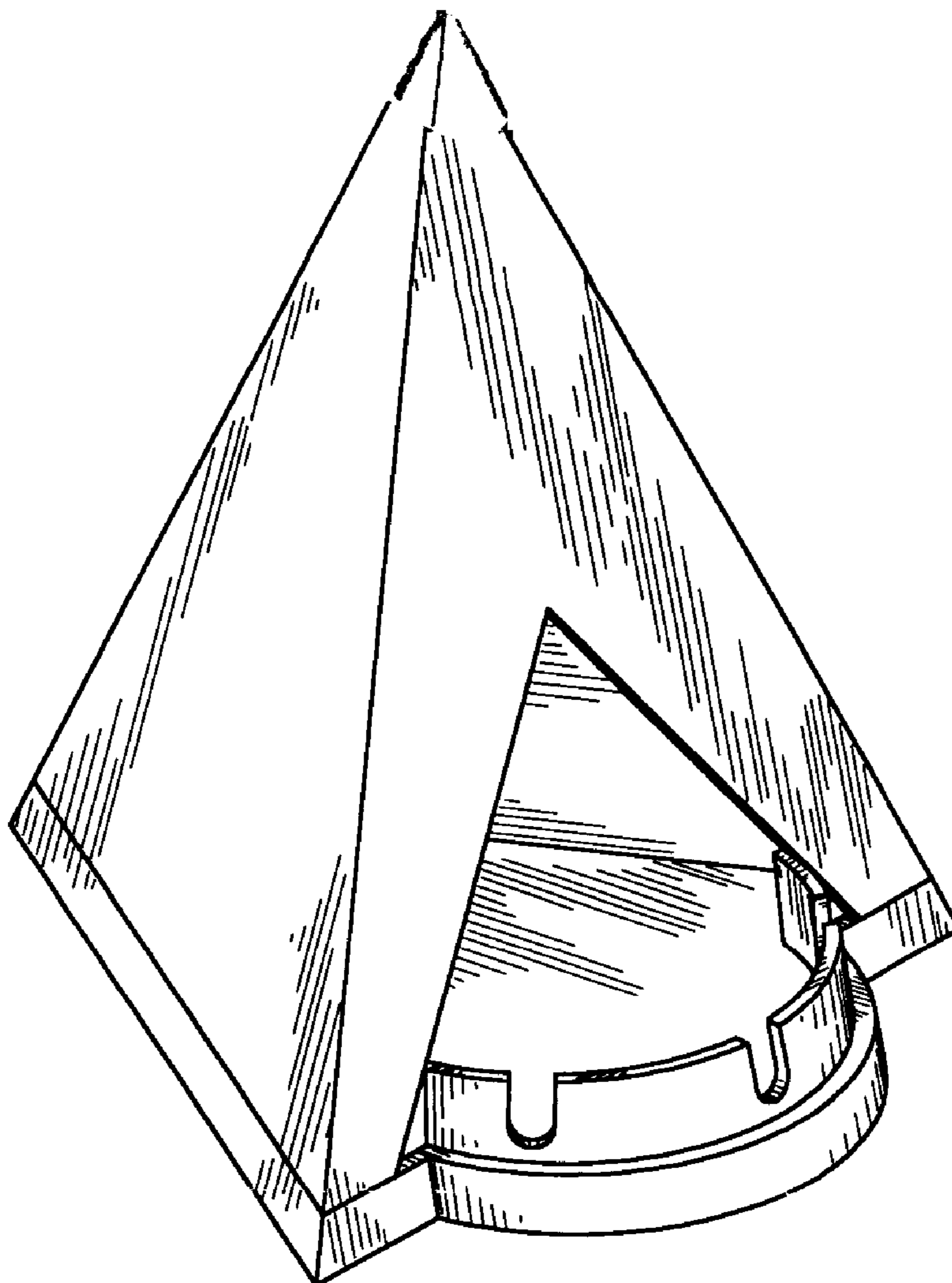

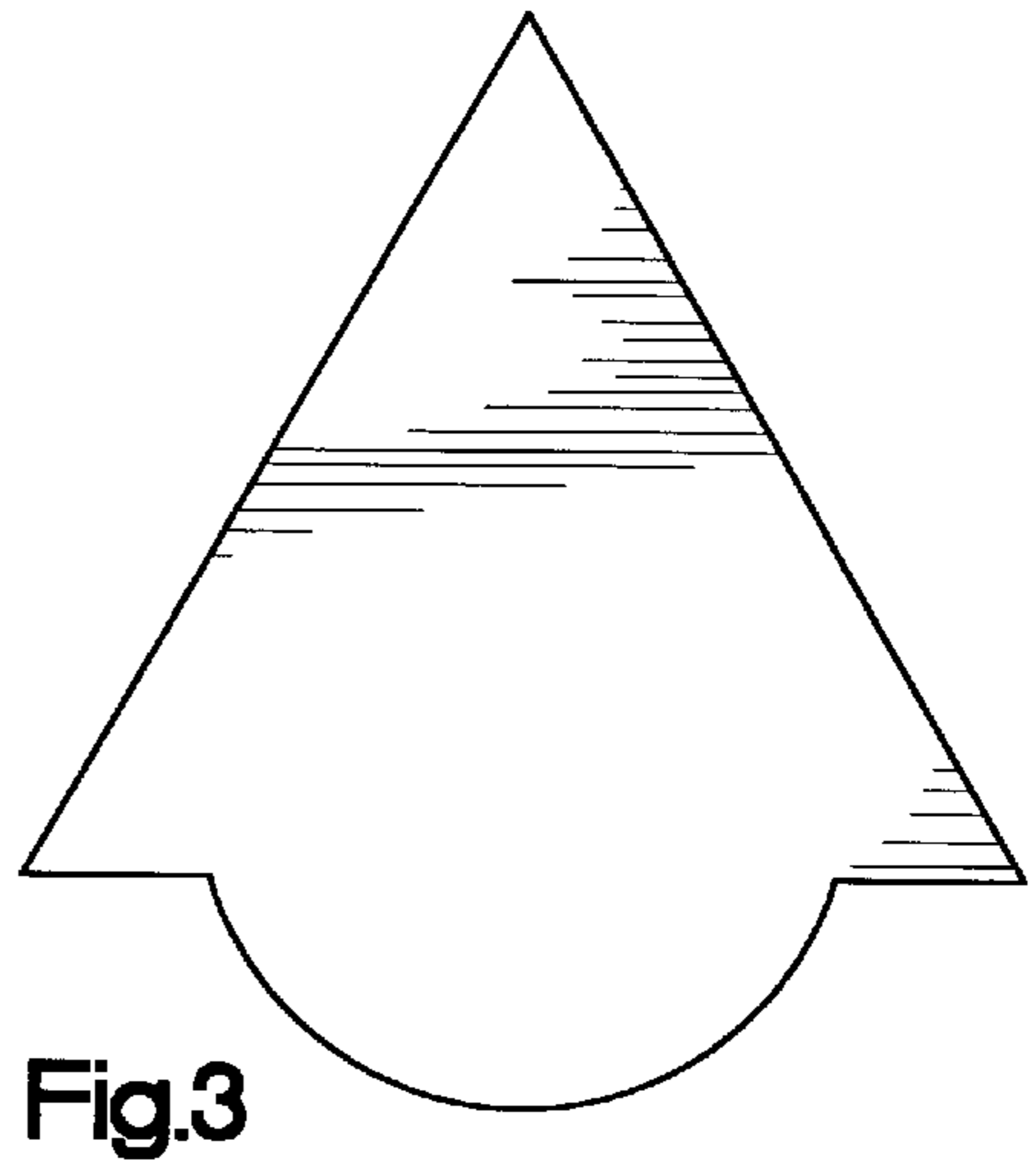
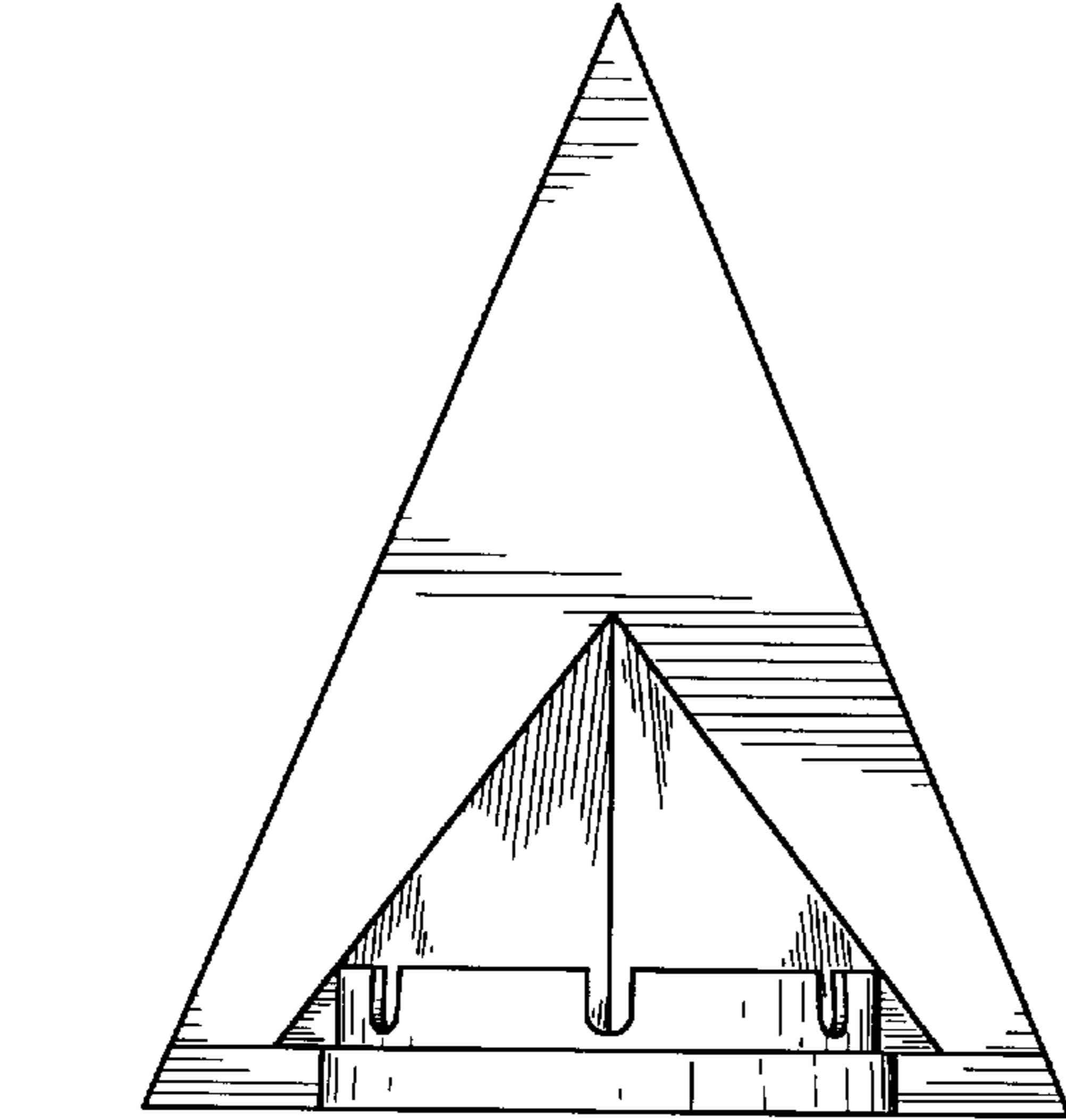
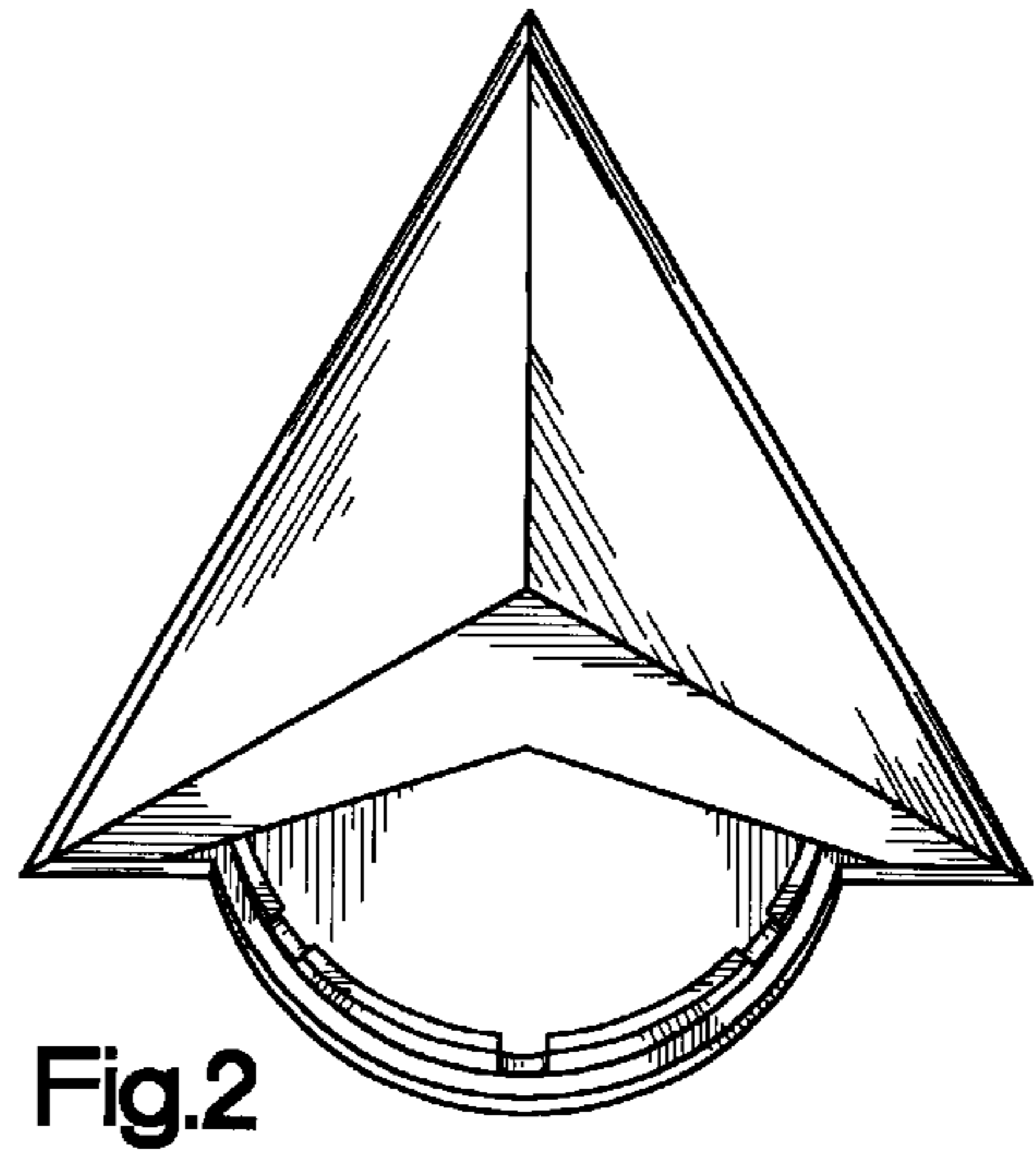
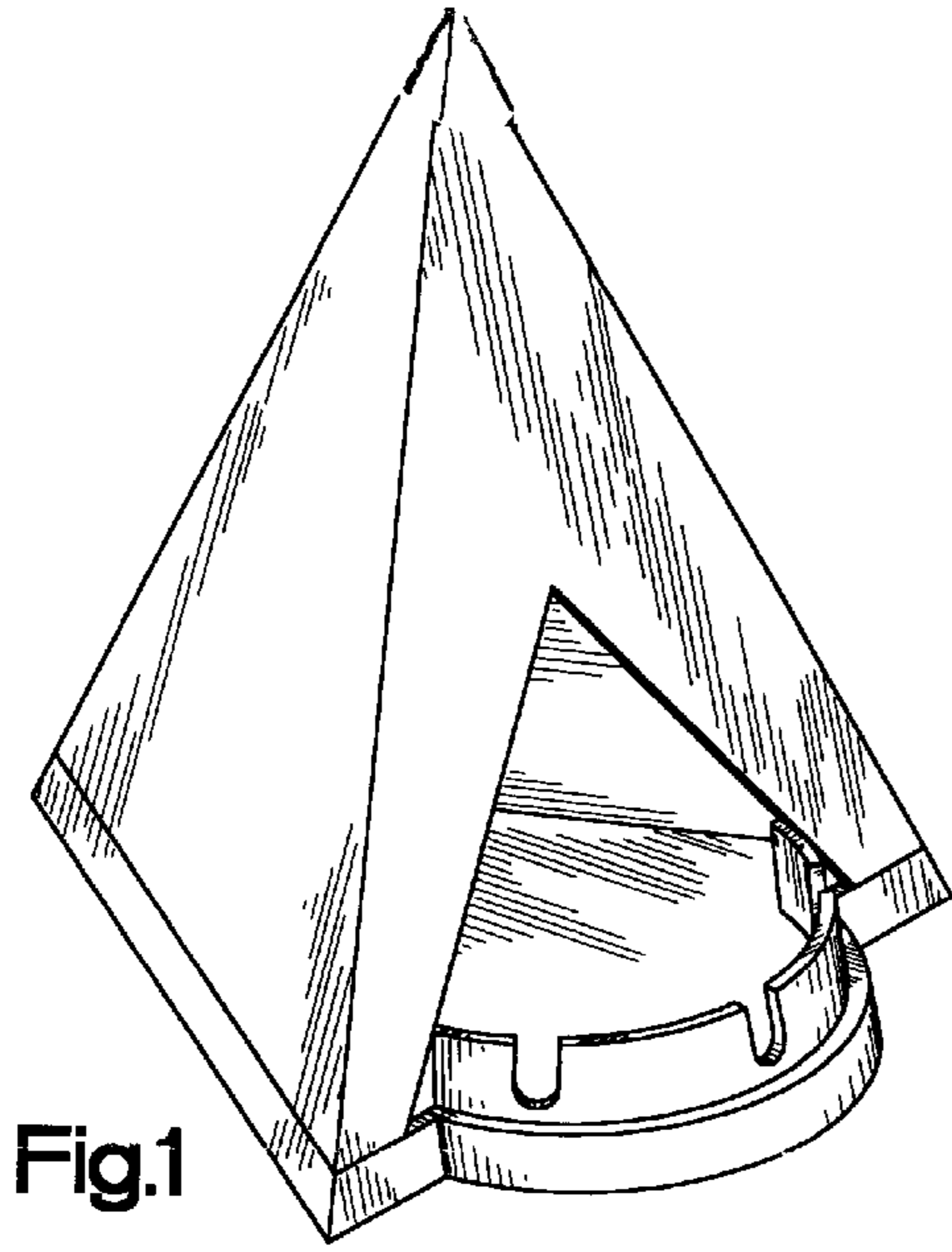

Fig. 4

Fig. 3

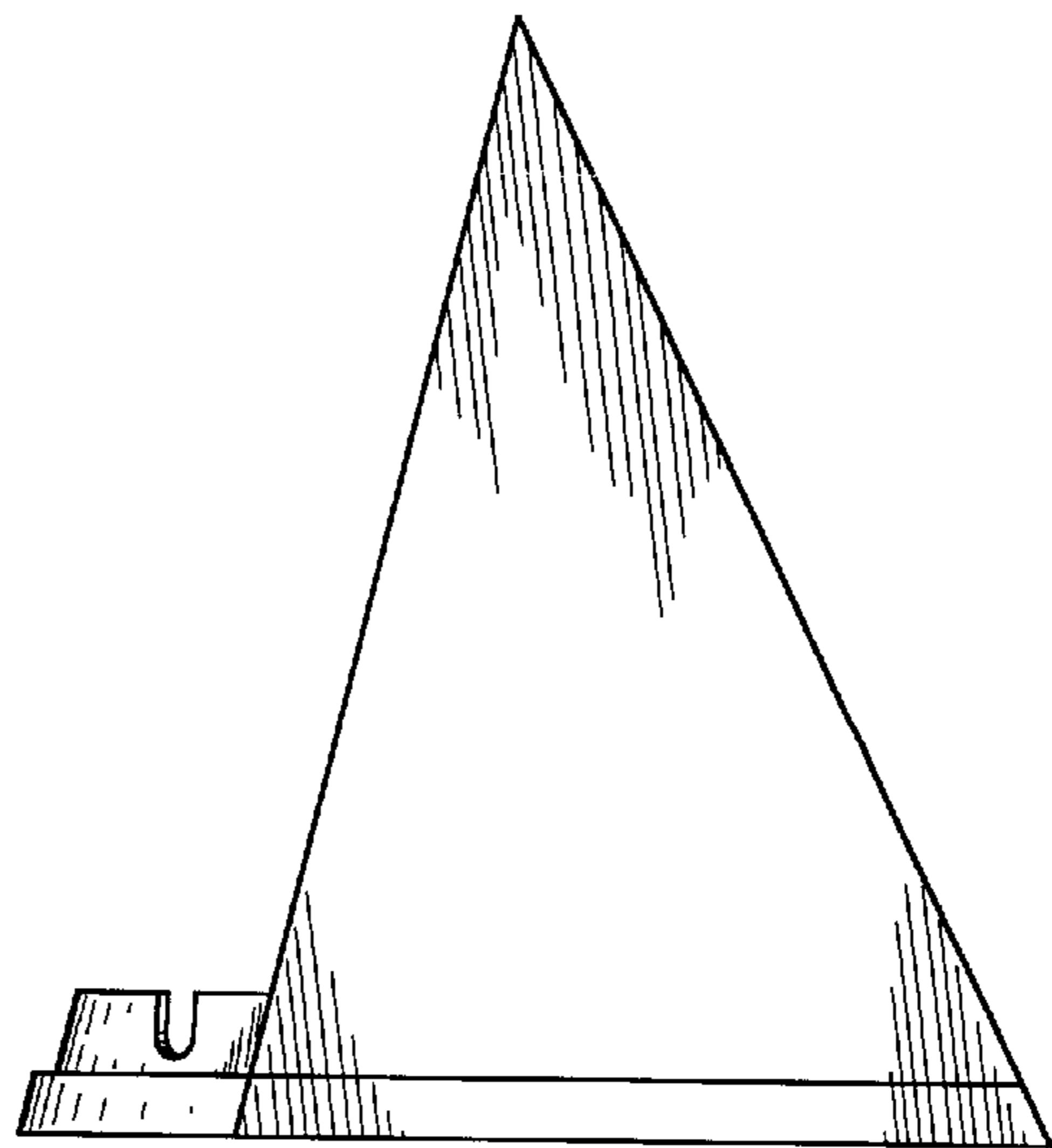
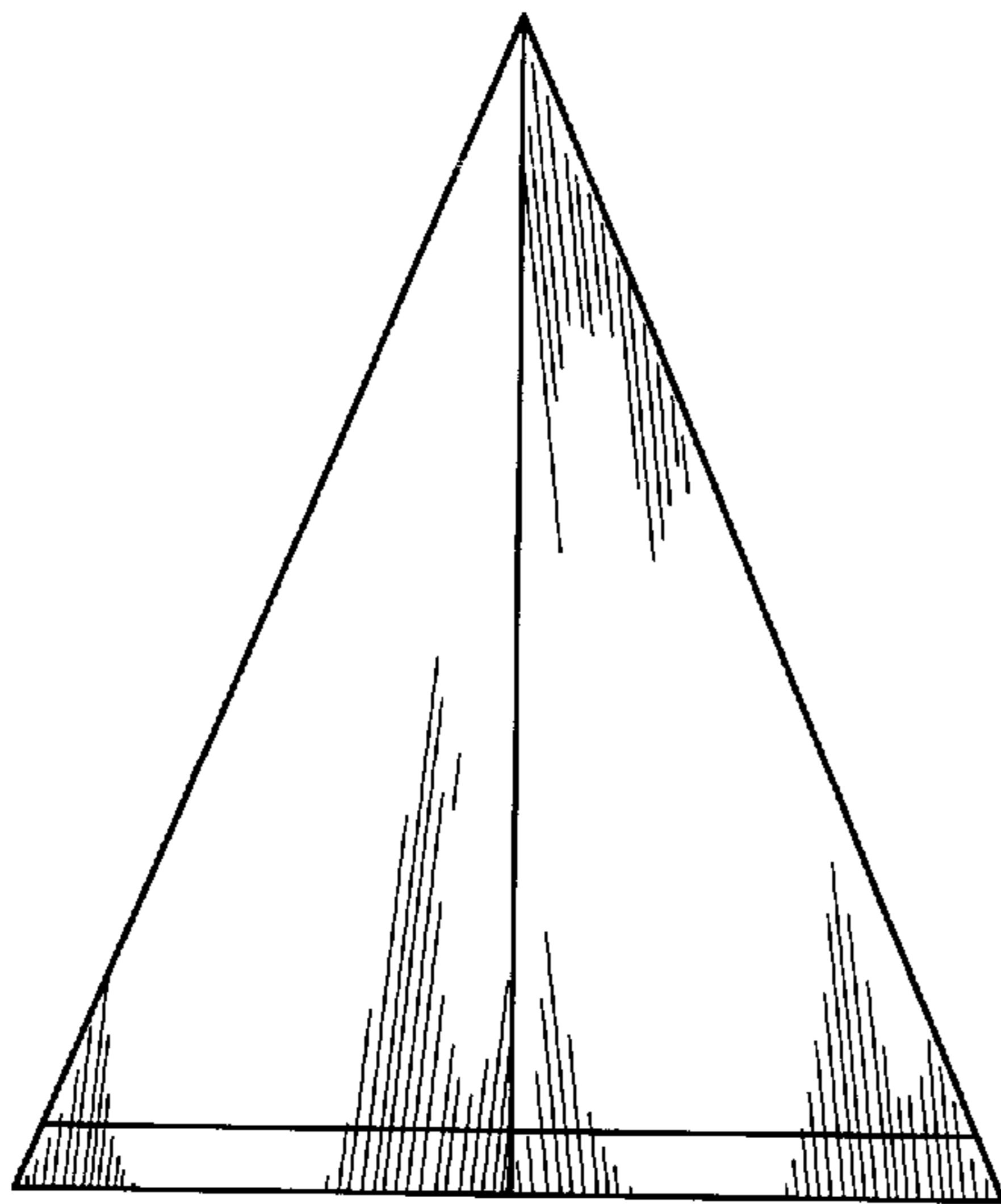

Fig. 5

Fig. 6