



US00D409405S

United States Patent [19]
Schultz et al.

[11] **Patent Number: Des. 409,405**

[45] **Date of Patent: ** May 11, 1999**

[54] **CHAIR**

[75] Inventors: **Craig H. Schultz; Douglass A. Schroeder**, both of Muscatine, Iowa

[73] Assignee: **HON Technology Inc.**, Muscatine, Iowa

[**] Term: **14 Years**

[21] Appl. No.: **29/082,913**

[22] Filed: **Jan. 30, 1998**

[51] **LOC (6) Cl.** **06-01**

[52] **U.S. Cl.** **D6/372; D6/379**

[58] **Field of Search** D6/334, 371, 372,
D6/373, 374, 375, 379, 500, 501, 502;
297/445.1, 451.3, 451.7

[56] **References Cited**

U.S. PATENT DOCUMENTS

D. 276,104 10/1984 Keeler D6/372

D. 277,907 3/1985 Keeler D6/372
D. 301,663 6/1989 Vonhausen D6/372
D. 326,371 5/1992 Buchacz D6/372
D. 388,270 12/1997 Schultz et al. D6/501
D. 390,384 2/1998 Schultz et al. D6/500

Primary Examiner—Gary D. Watson
Attorney, Agent, or Firm—Jones, Day, Reavis & Pogue

[57] **CLAIM**

The ornamental design for a chair, as shown and described.

DESCRIPTION

FIG. 1 is a right perspective view of a chair showing our new design;
FIG. 2 is a front view thereof;
FIG. 3 is a rear view thereof;
FIG. 4 is a top view thereof;
FIG. 5 is a left side view, the opposite side view being a mirror image thereof; and,
FIG. 6 is a bottom view thereof.

1 Claim, 3 Drawing Sheets

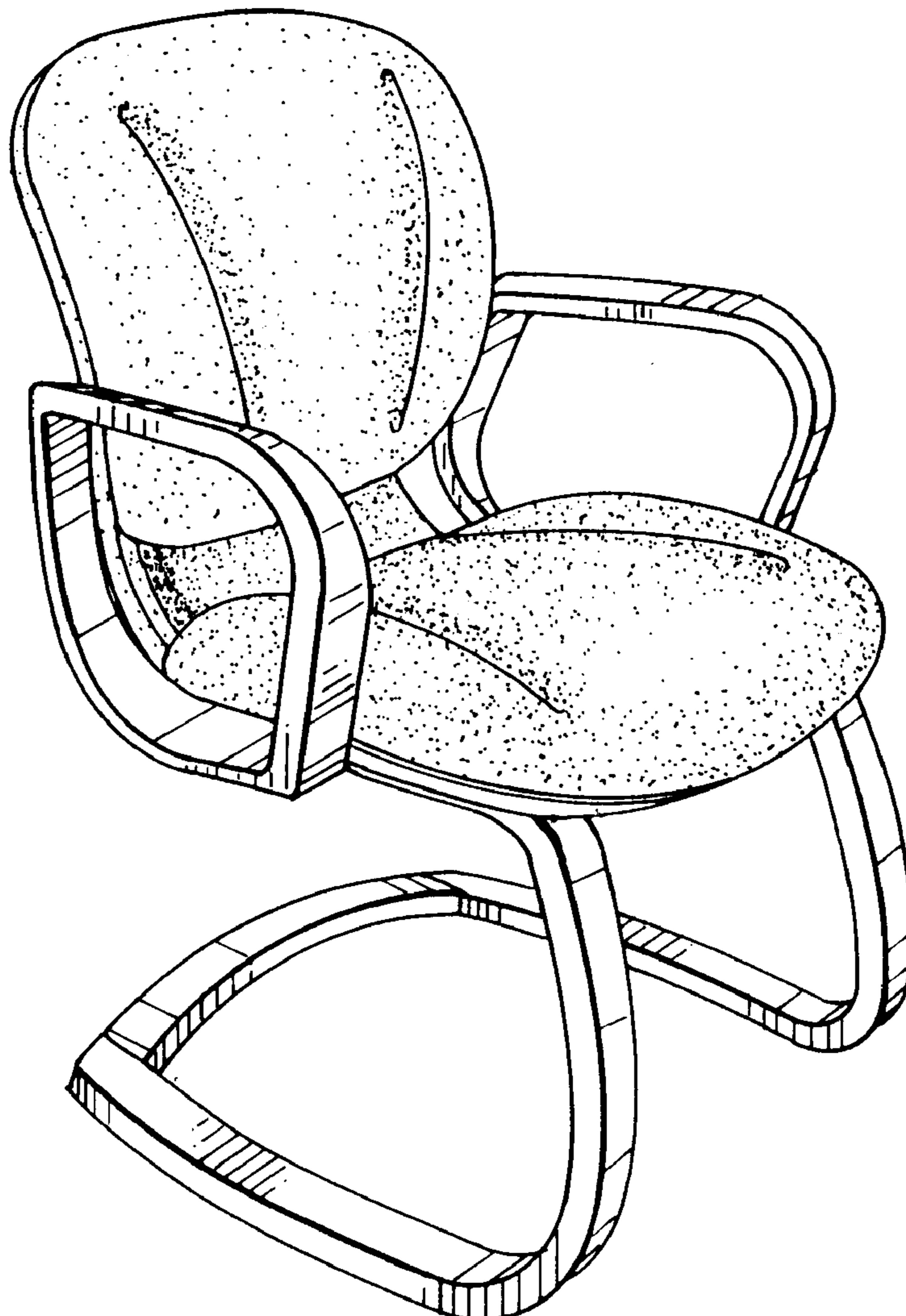

FIG. 1

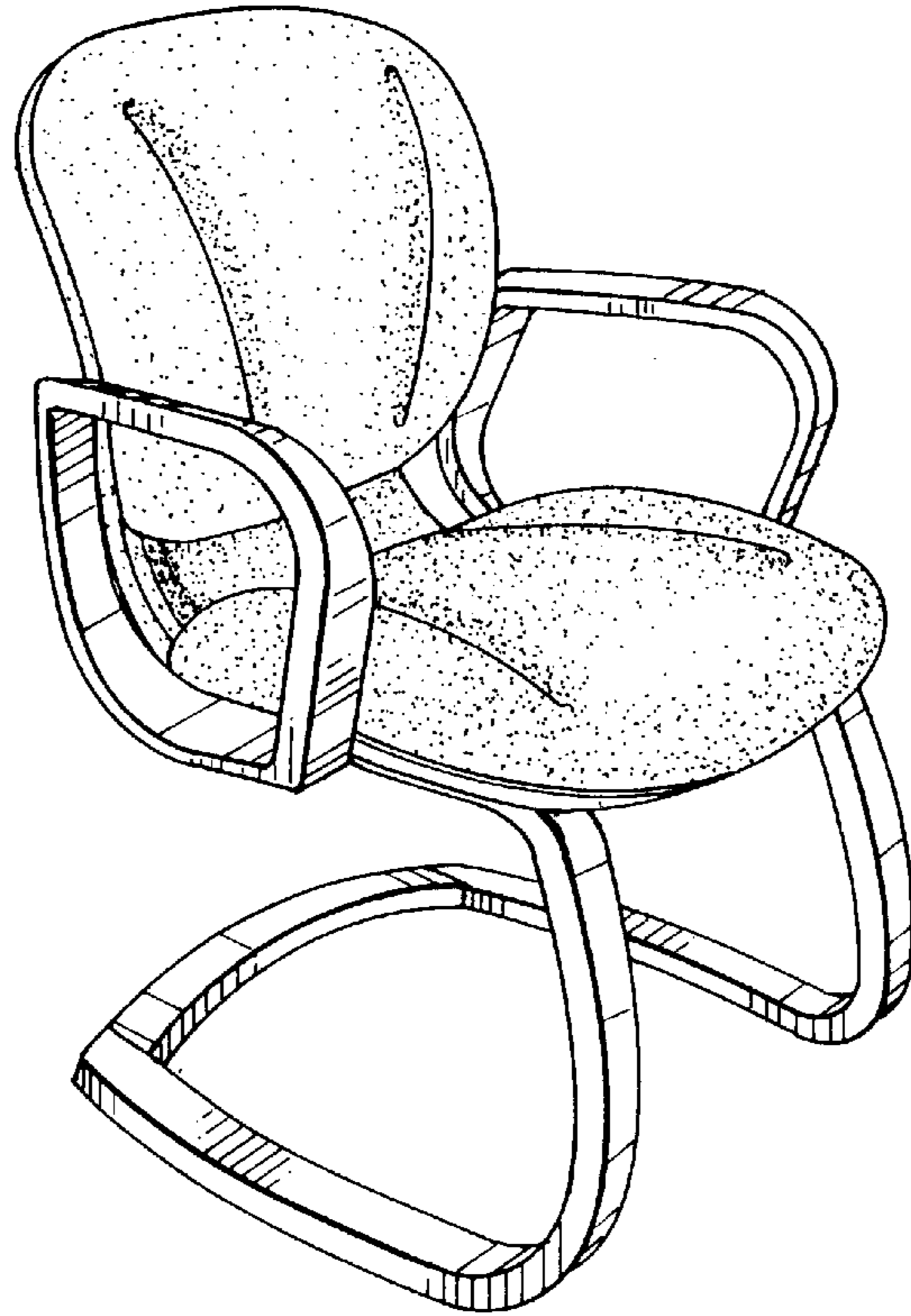

FIG. 2

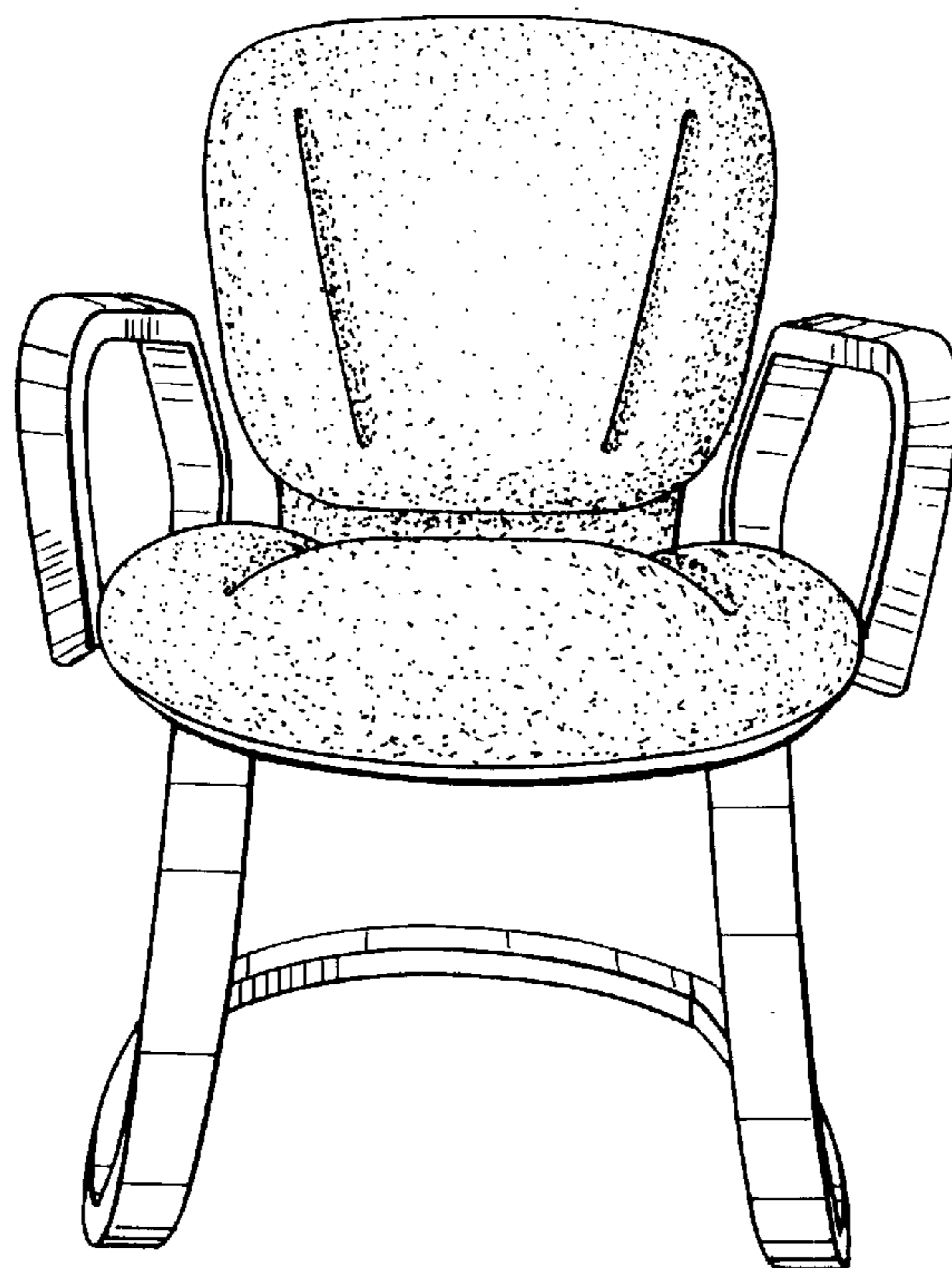

FIG. 3

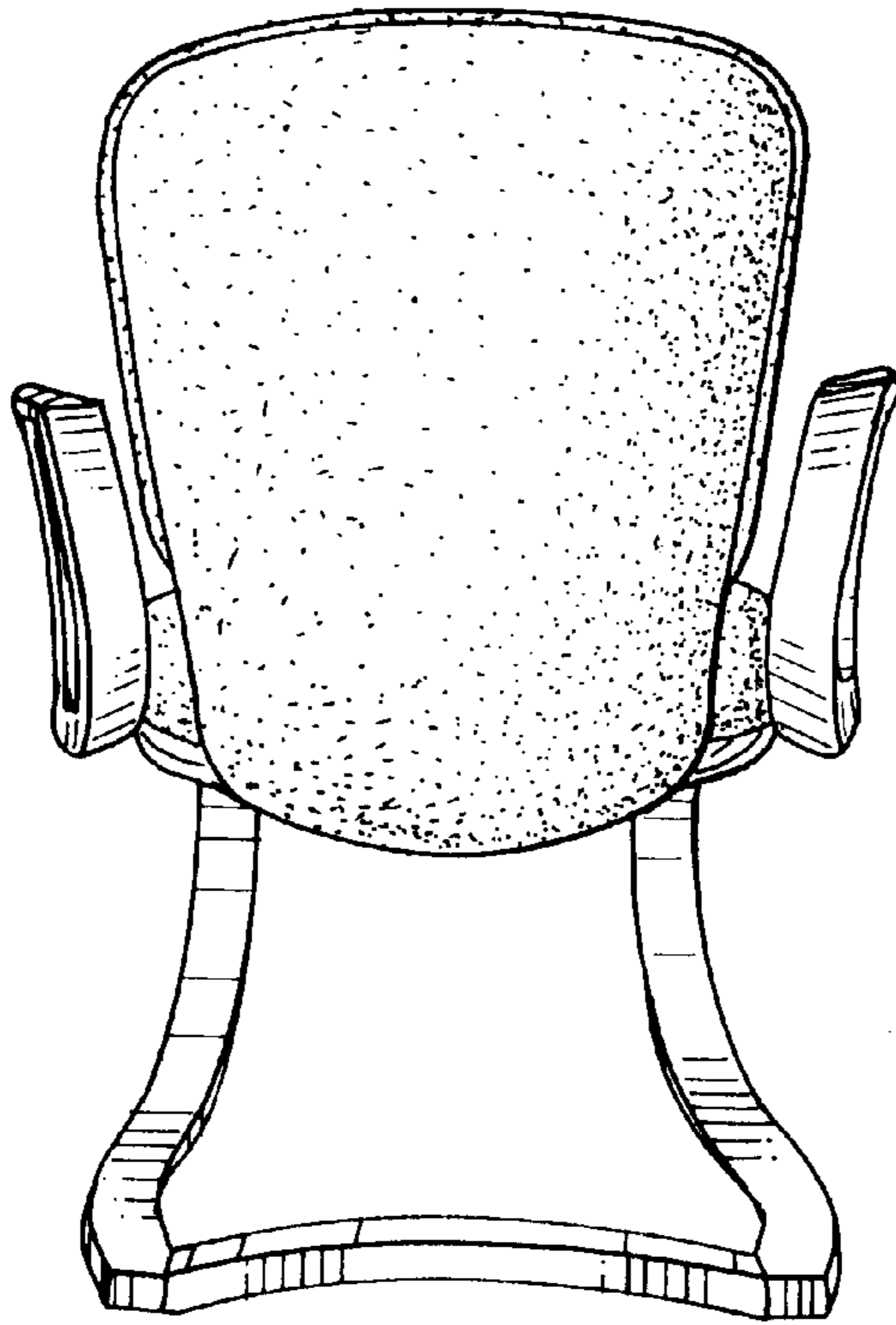

FIG. 4

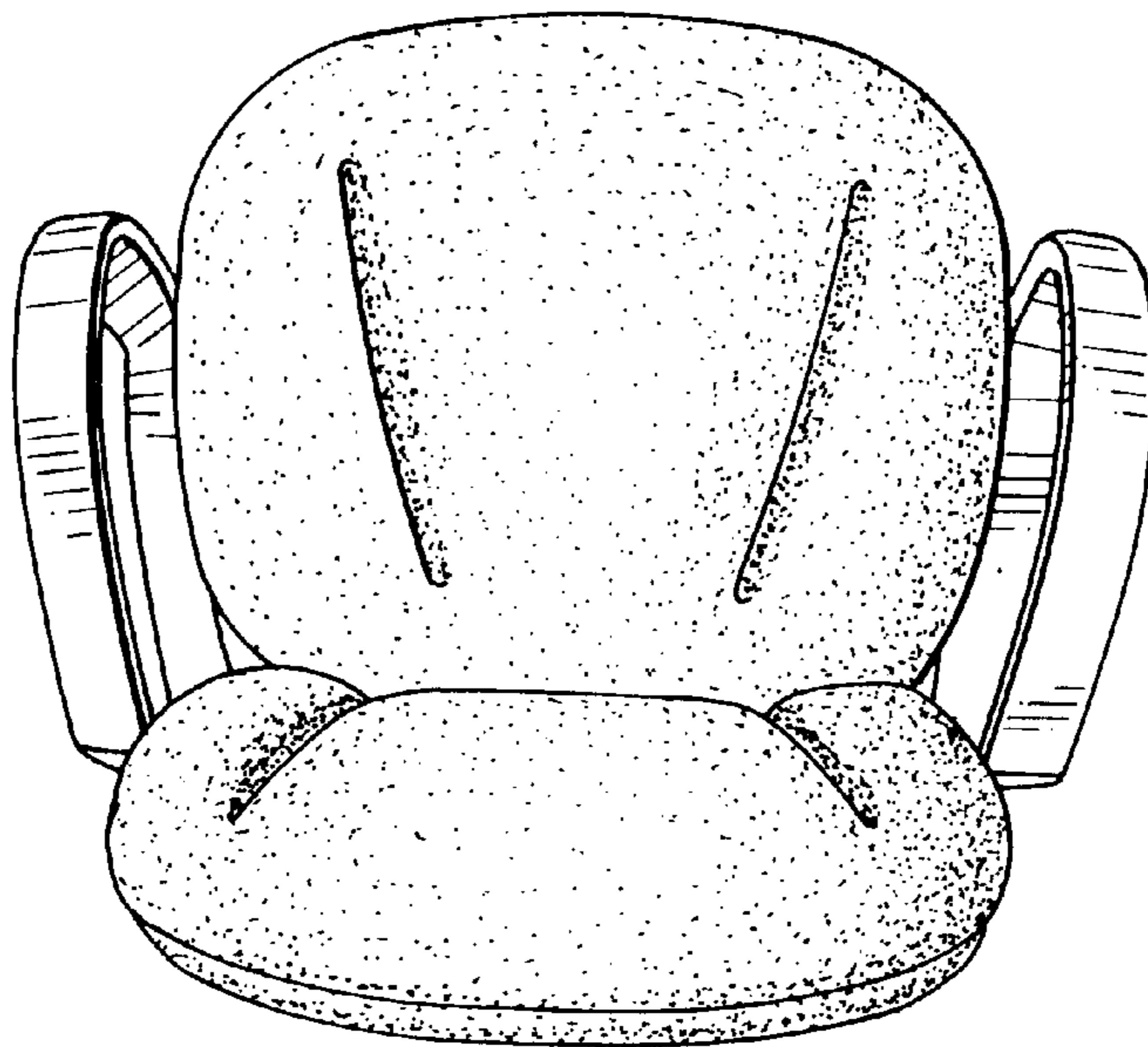

FIG. 5

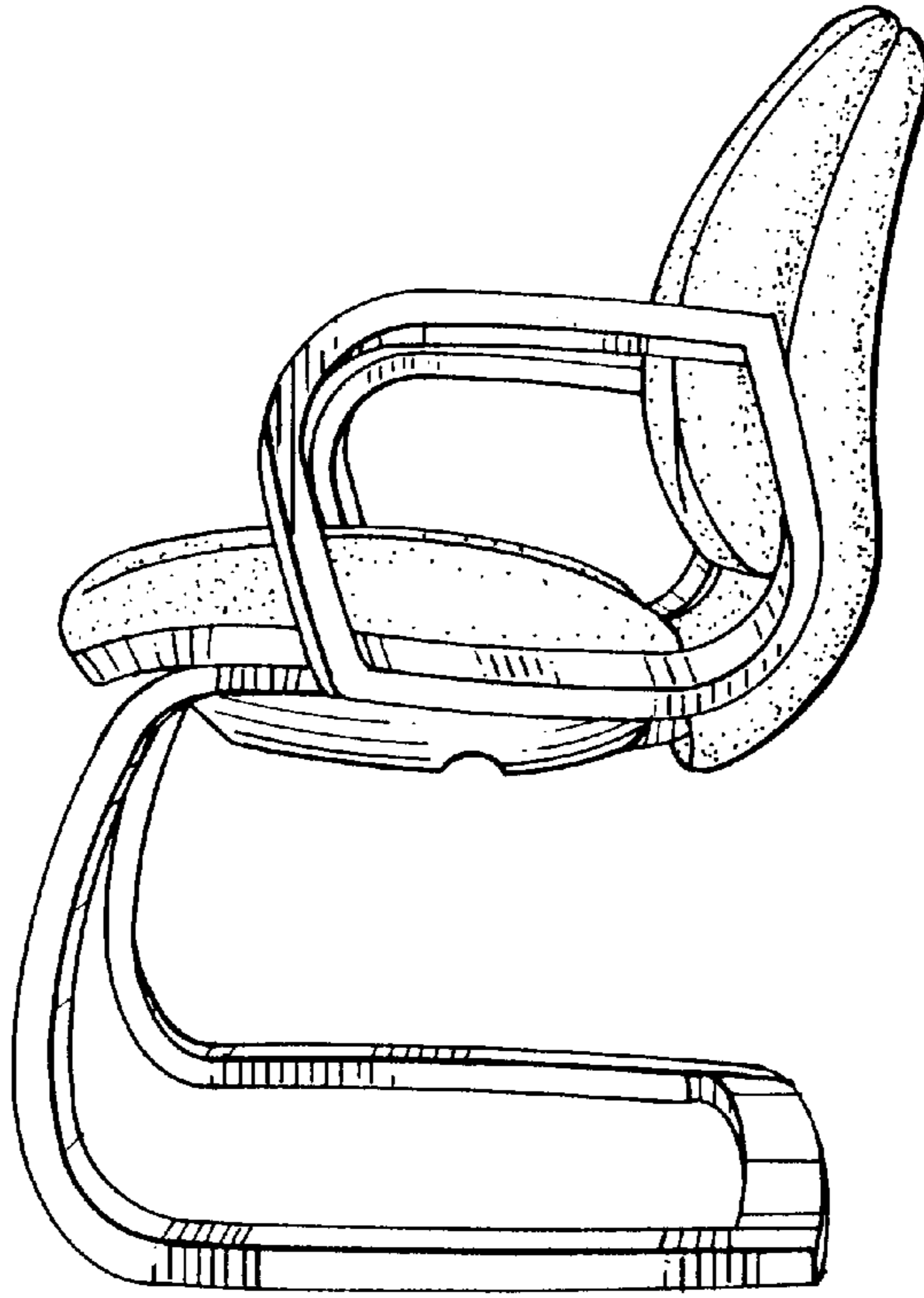
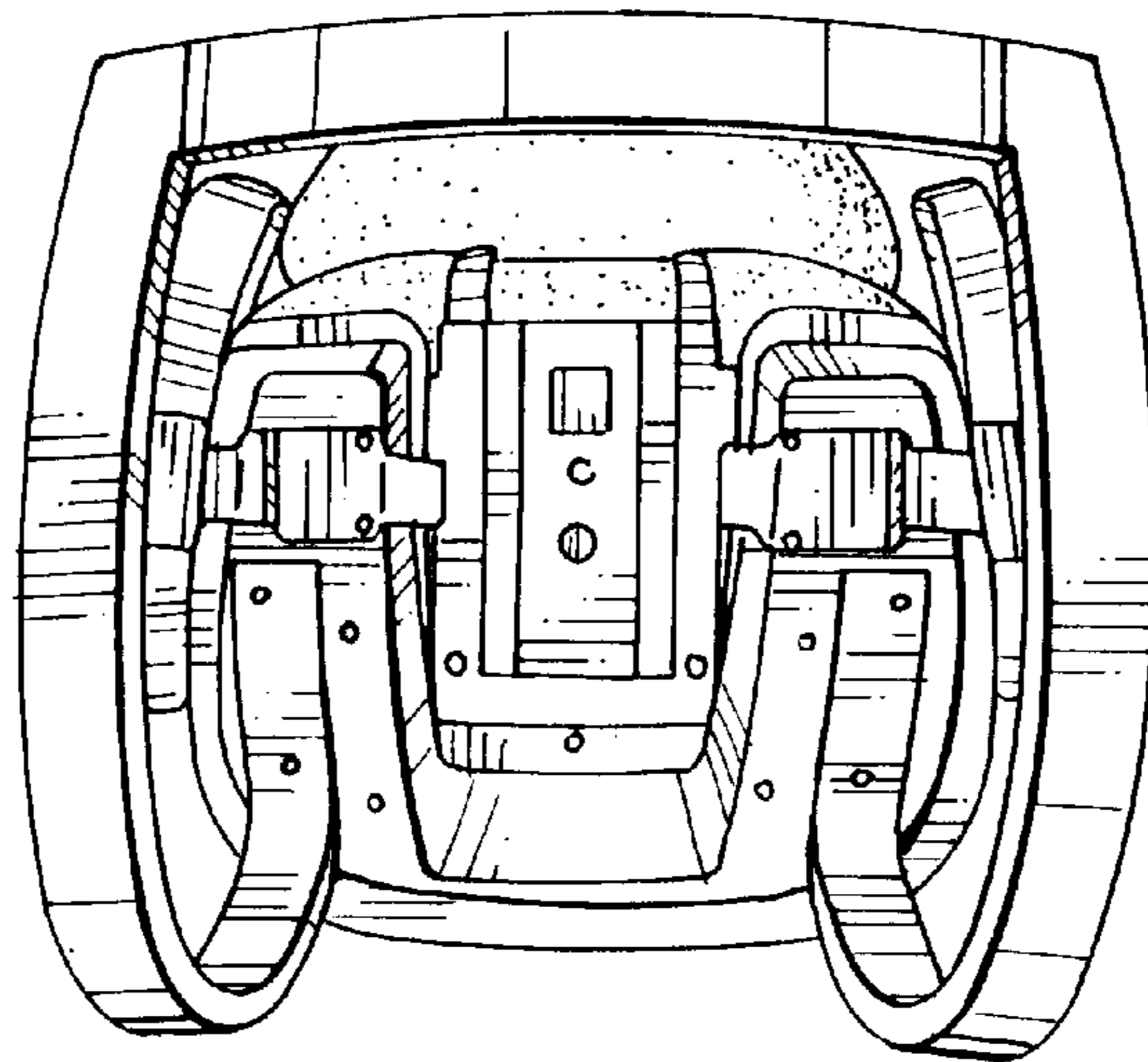

FIG. 6



UNITED STATES PATENT AND TRADEMARK OFFICE
CERTIFICATE OF CORRECTION

PATENT NO. : Des 409,405
DATED : May 11, 1999
INVENTOR(S) : Craig H. Schultz et al.

Page 1 of 1

It is certified that error appears in the above-identified patent and that said Letters Patent is hereby corrected as shown below:

Title page,
Item [75], change "**Douglass**" to -- **Douglas** --.

Signed and Sealed this

Third Day of September, 2002

Attest:

A handwritten signature in black ink, appearing to read "James E. Rogan", with a horizontal line drawn underneath it.

Attesting Officer

JAMES E. ROGAN
Director of the United States Patent and Trademark Office