



US00D409387S

# United States Patent [19] Yemini

[11] Patent Number: **Des. 409,387**

[45] Date of Patent: **\*\* May 11, 1999**

[54] **STACKABLE BIN**

[75] Inventor: **Zvi Yemini**, Tel Aviv, Israel

[73] Assignee: **ZAG Ltd.**, Rosh Haayin, Israel

[\*\*] Term: **14 Years**

[21] Appl. No.: **29/063,178**

[22] Filed: **Dec. 2, 1996**

[51] **LOC (6) Cl.** ..... **03-01**

[52] **U.S. Cl.** ..... **D3/307; D3/304; D3/312**

[58] **Field of Search** ..... D3/309, 314, 312,  
D3/304, 307, 308; D7/605, 708, 603, 602,  
550, 601, 354; D9/424, 425, 429; 220/669,  
671, 676

[56] **References Cited**

**U.S. PATENT DOCUMENTS**

D. 186,819 12/1959 Schaeffer ..... D7/602

D. 188,613 8/1960 Gottsegen ..... D7/602  
D. 314,279 2/1991 Hotchkiss ..... D3/309  
D. 329,135 9/1992 Embree ..... D3/308  
D. 346,741 5/1994 McIntire ..... D9/425 X  
3,379,339 4/1968 Asenbauer ..... D3/314 X

*Primary Examiner*—M. N. Pandozzi  
*Attorney, Agent, or Firm*—Pillsbury Madison & Sutro LLP

[57] **CLAIM**

The ornamental design for a stackable bin, as shown.

**DESCRIPTION**

FIG. 1 is a perspective view showing the stackable bin;  
FIG. 2 is a top view of the stackable bin;  
FIG. 3 is a bottom view of the stackable bin;  
FIG. 4 is a left side view of the stackable bin;  
FIG. 5 is a right side view of the stackable bin; and,  
FIG. 6 is an end view of the stackable bin.

**1 Claim, 6 Drawing Sheets**

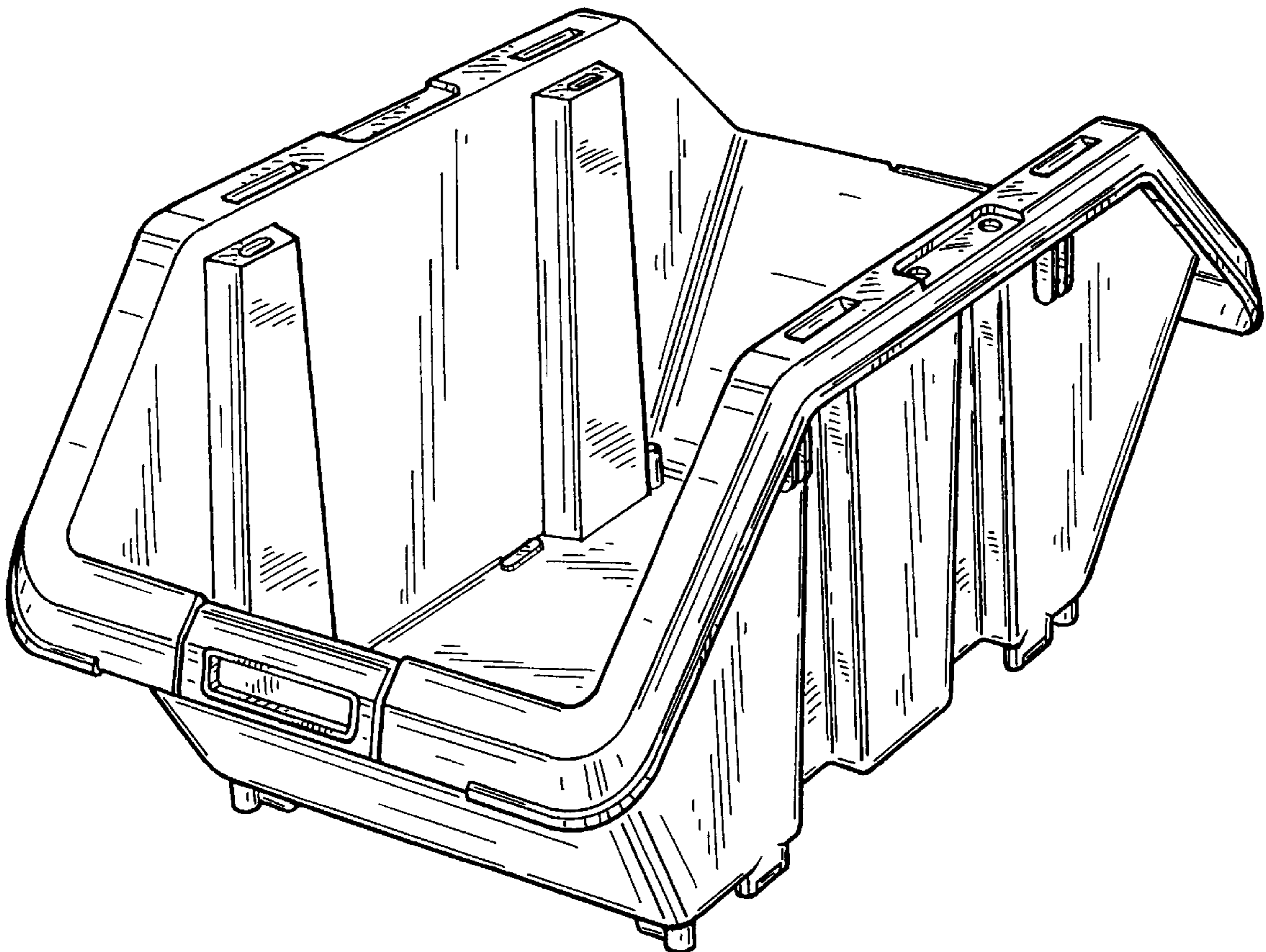

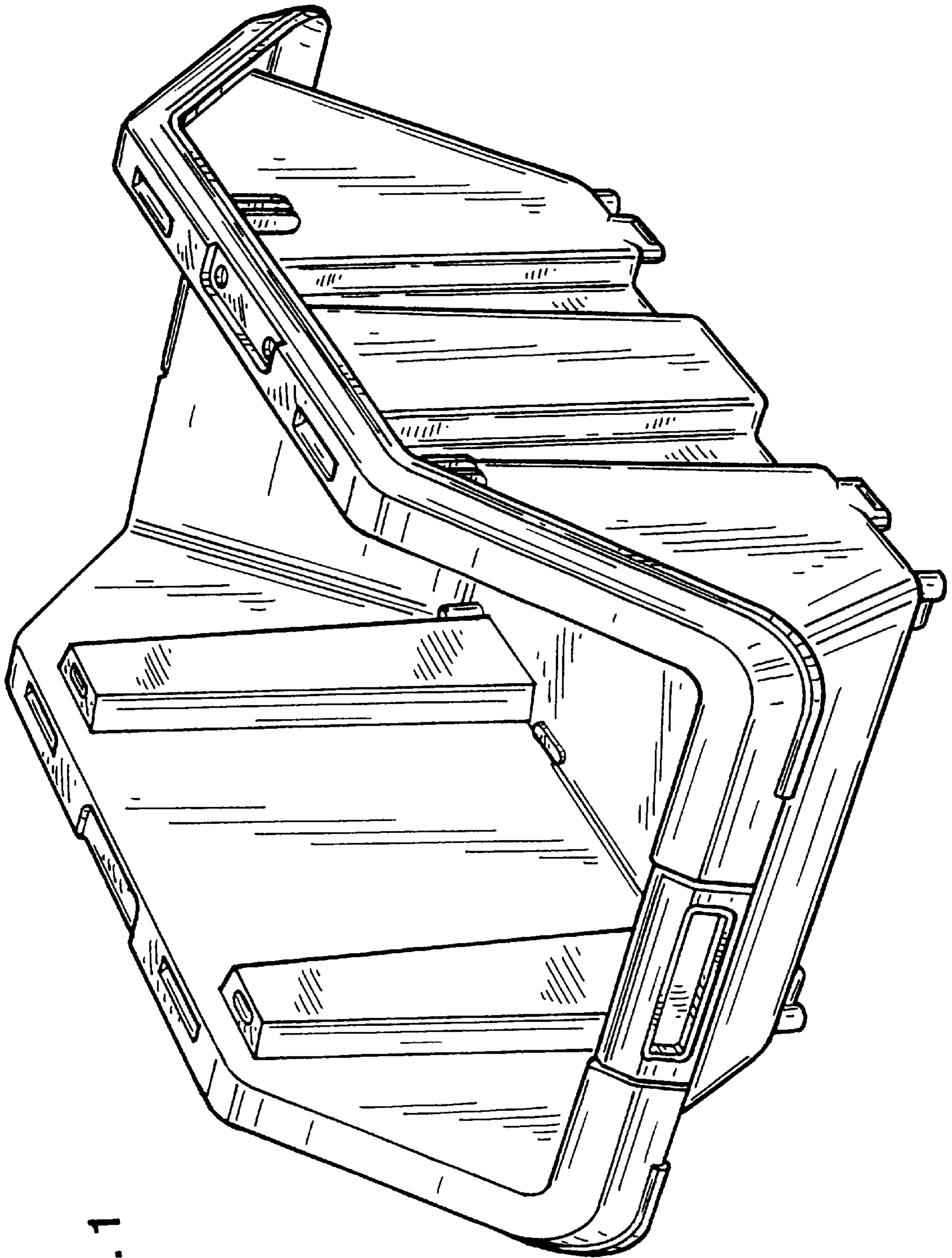

FIG. 1

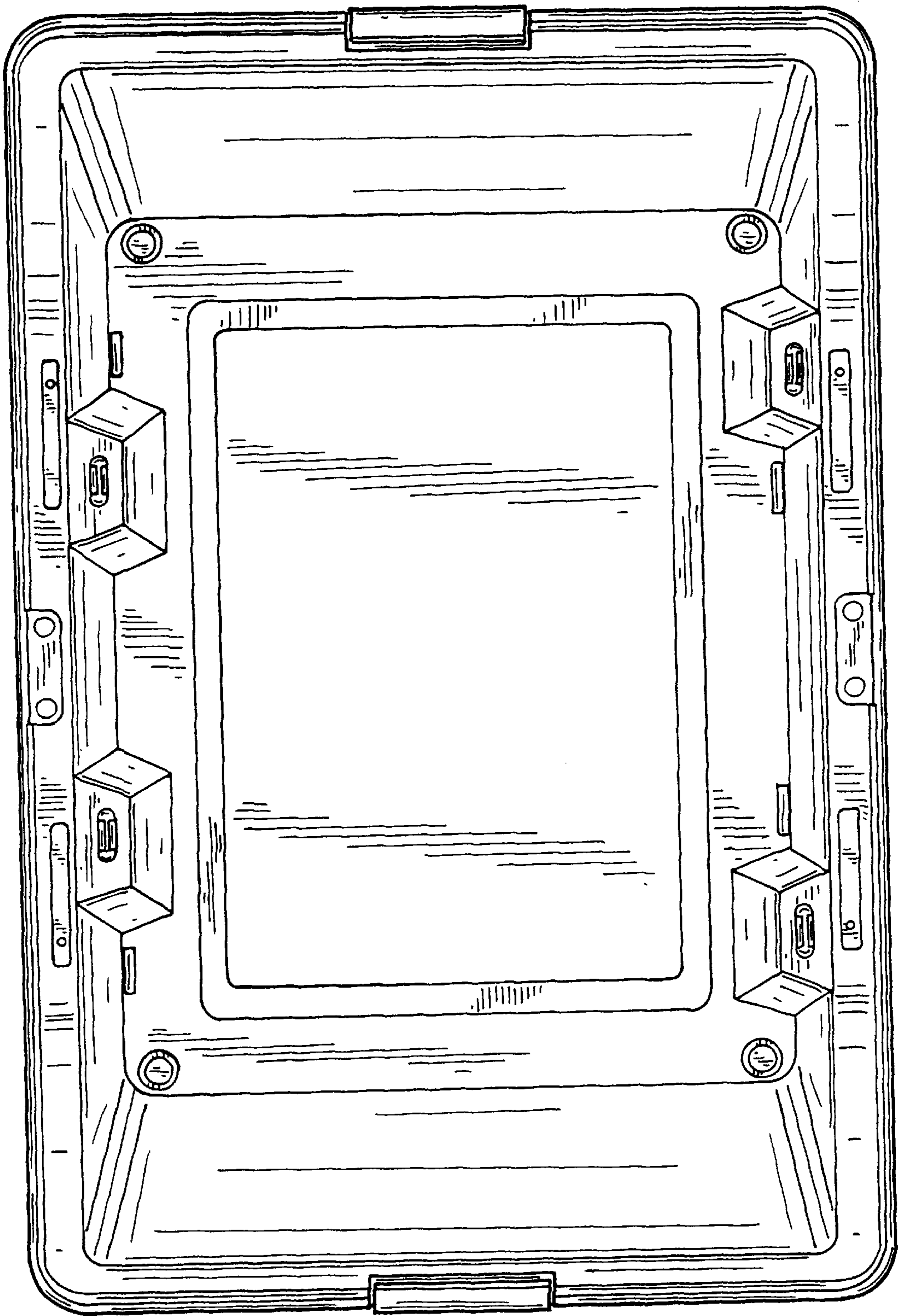

FIG. 2

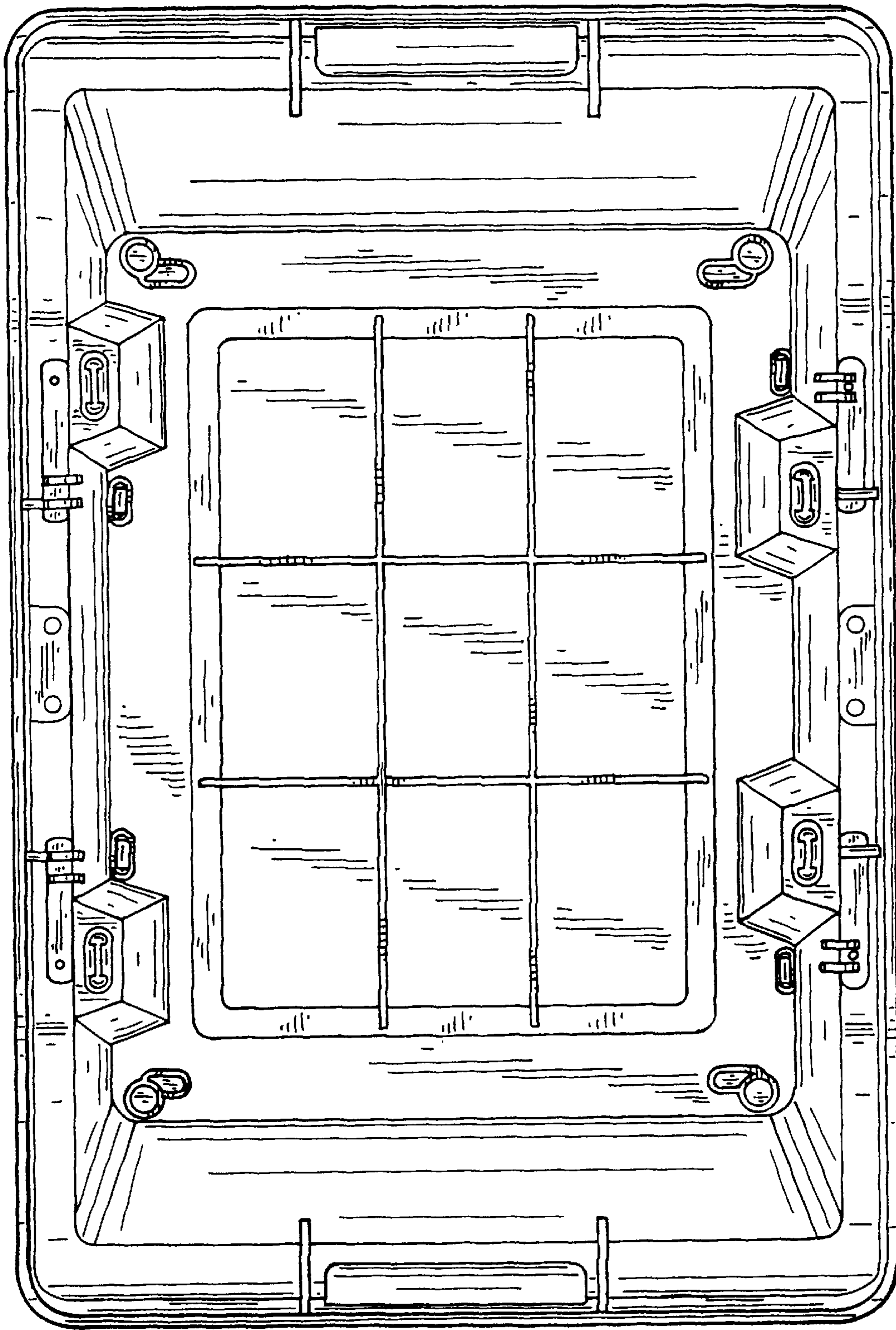

FIG. 3

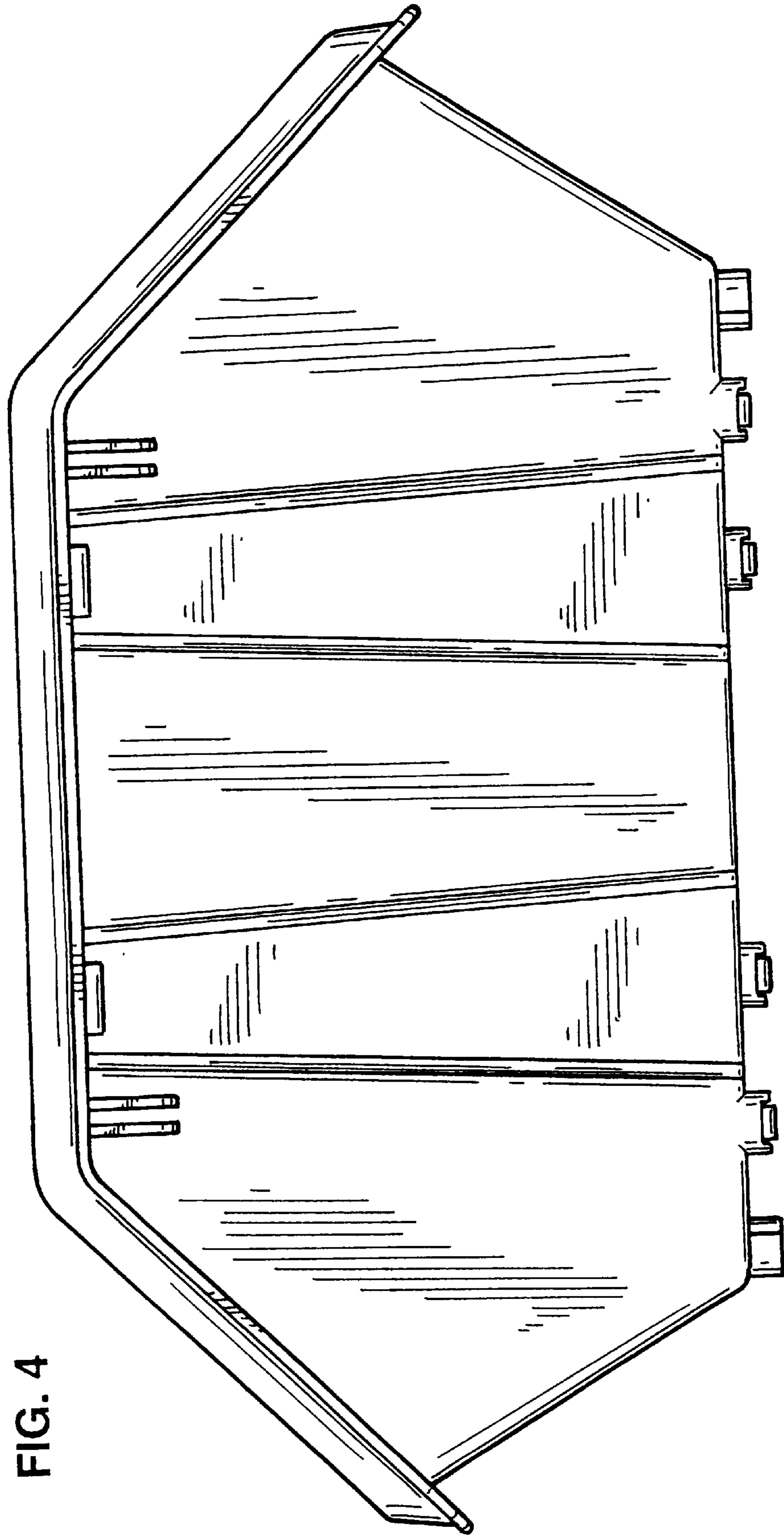

FIG. 4

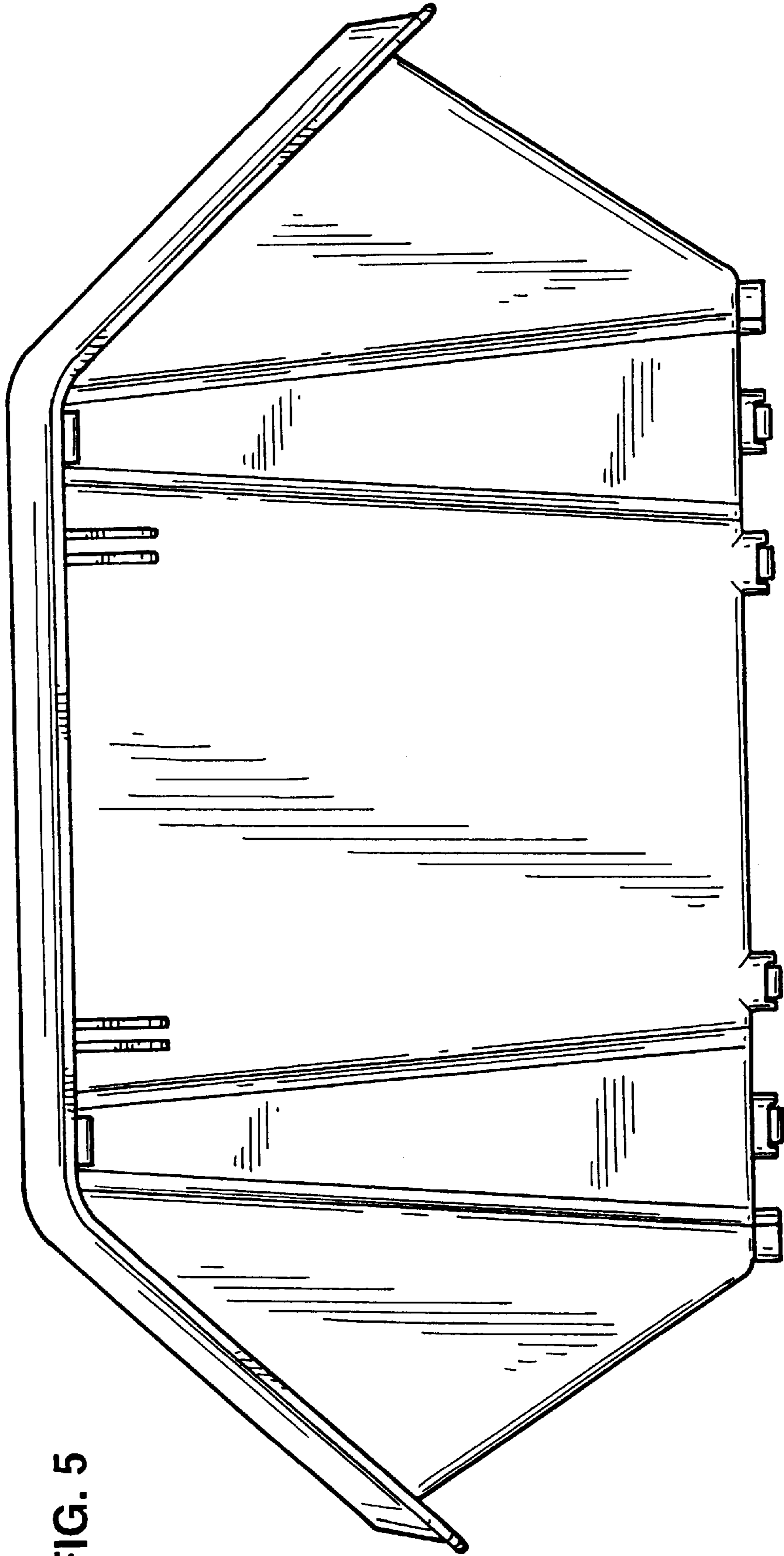

FIG. 5

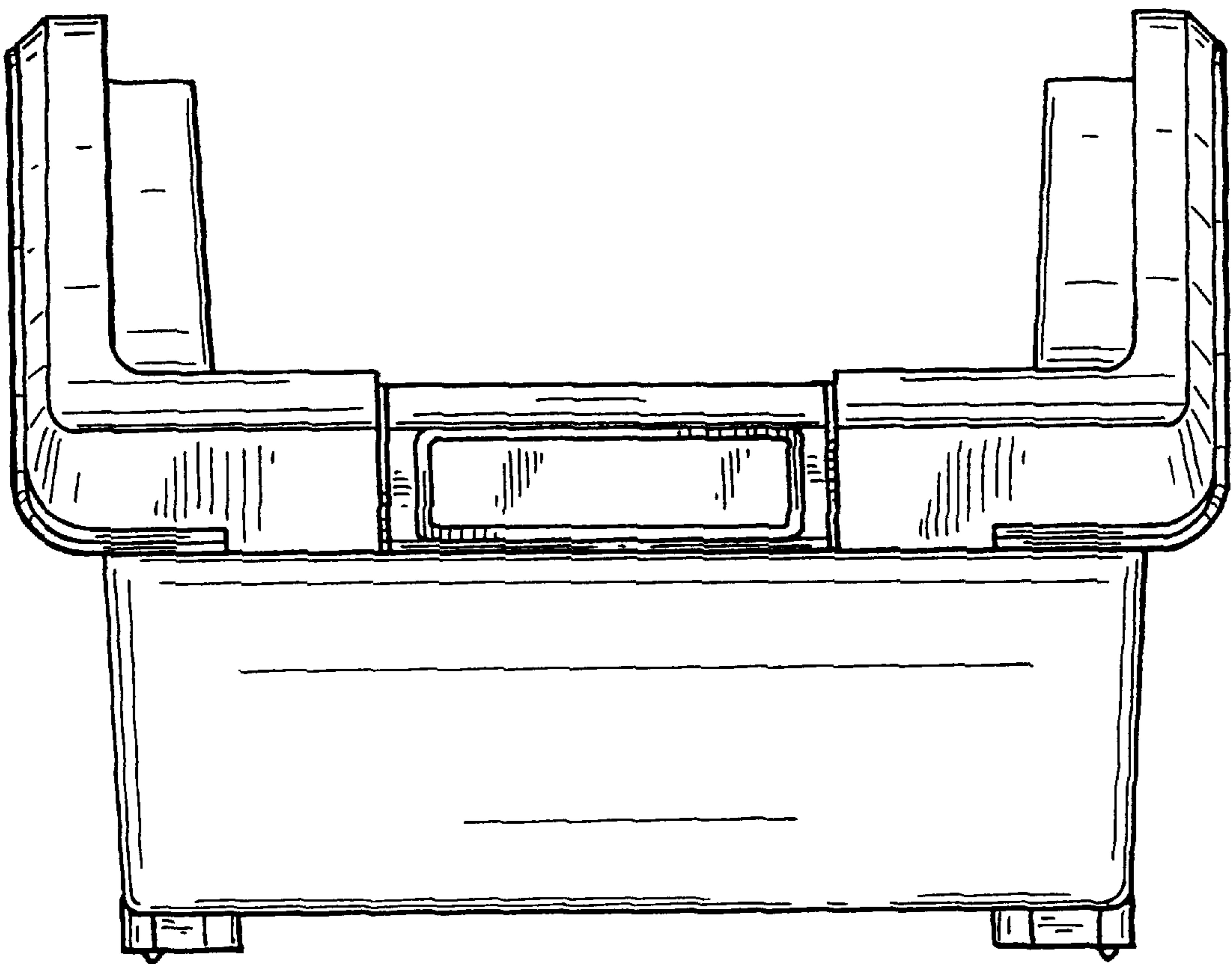

FIG. 6