



US00D409331S

United States Patent [19] Minami

[11] Patent Number: **Des. 409,331**

[45] Date of Patent: **** May 4, 1999**

[54] **HAIR TREATMENT PROMOTING DEVICE**

[75] Inventor: **Nobuyuki Minami**, Osaka, Japan

[73] Assignee: **Oohiro Works Ltd.**, Osaka, Japan

[**] Term: **14 Years**

[21] Appl. No.: **29/062,105**

[22] Filed: **Nov. 7, 1996**

[30] **Foreign Application Priority Data**

Sep. 25, 1996 [JP] Japan 8-28772

[51] **LOC (6) Cl.** **28-03**

[52] **U.S. Cl.** **D28/17**

[58] **Field of Search** D28/9, 10-12,
D28/15, 17, 18, 19; 132/212, 271, 272;
34/96-100; 392/380-383

[56] **References Cited**

U.S. PATENT DOCUMENTS

D. 235,383	6/1975	McNair	D28/18
D. 314,065	1/1991	Kakuya	D28/17
D. 321,411	11/1991	Moll	D28/17
2,208,675	7/1940	Keany	132/212
4,541,442	9/1985	Hollmann et al.	132/212
4,910,382	3/1990	Kakuya et al.	219/222
5,063,688	11/1991	Moll et al.	34/97
5,231,770	8/1993	Fertig	34/96 X
5,268,988	12/1993	Miyamoto et al.	132/212 X

FOREIGN PATENT DOCUMENTS

537635	11/1930	Germany	34/99
4235436	4/1993	Germany	392/392
26449	11/1932	Netherlands	392/380
276864	7/1951	Switzerland	34/99

Primary Examiner—Ted Shooman

Assistant Examiner—C. Tuttle

Attorney, Agent, or Firm—Wenderoth Lind & Ponack L.L.P.

[57] **CLAIM**

The ornamental design for a hair treatment promoting device, as shown and described.

DESCRIPTION

FIG. 1 is a front view of a hair treatment promoting device in accordance with the present design;

FIG. 2 is a back view thereof;

FIG. 3 is a top plan view thereof;

FIG. 4 is a right side view thereof;

FIG. 5 is a left side view thereof;

FIG. 6 is a bottom plan view thereof;

FIG. 7 is an enlarged sectional view taken along line 7—7 of FIG. 1;

FIG. 8 is an enlarged sectional view taken along line 8—8 of FIG. 2;

FIG. 9 is a perspective view thereof;

FIG. 10 is a right side view showing the present design in a first position in its intended environment;

FIG. 11 is a view similar to FIG. 10 but showing the present design in a second position; and,

FIG. 12 is a view similar to FIGS. 10 and 11 but showing the present design in a third position.

The broken lines showing the stand and human form are for illustrative purposes only and form no part of the claimed design.

The present design is intended to be used at a beauty salon or a barber shop to promote or accelerate such hair treatment as perming, drying and hair drying. The design is intended to be mounted on a stand and electrically operated.

1 Claim, 3 Drawing Sheets

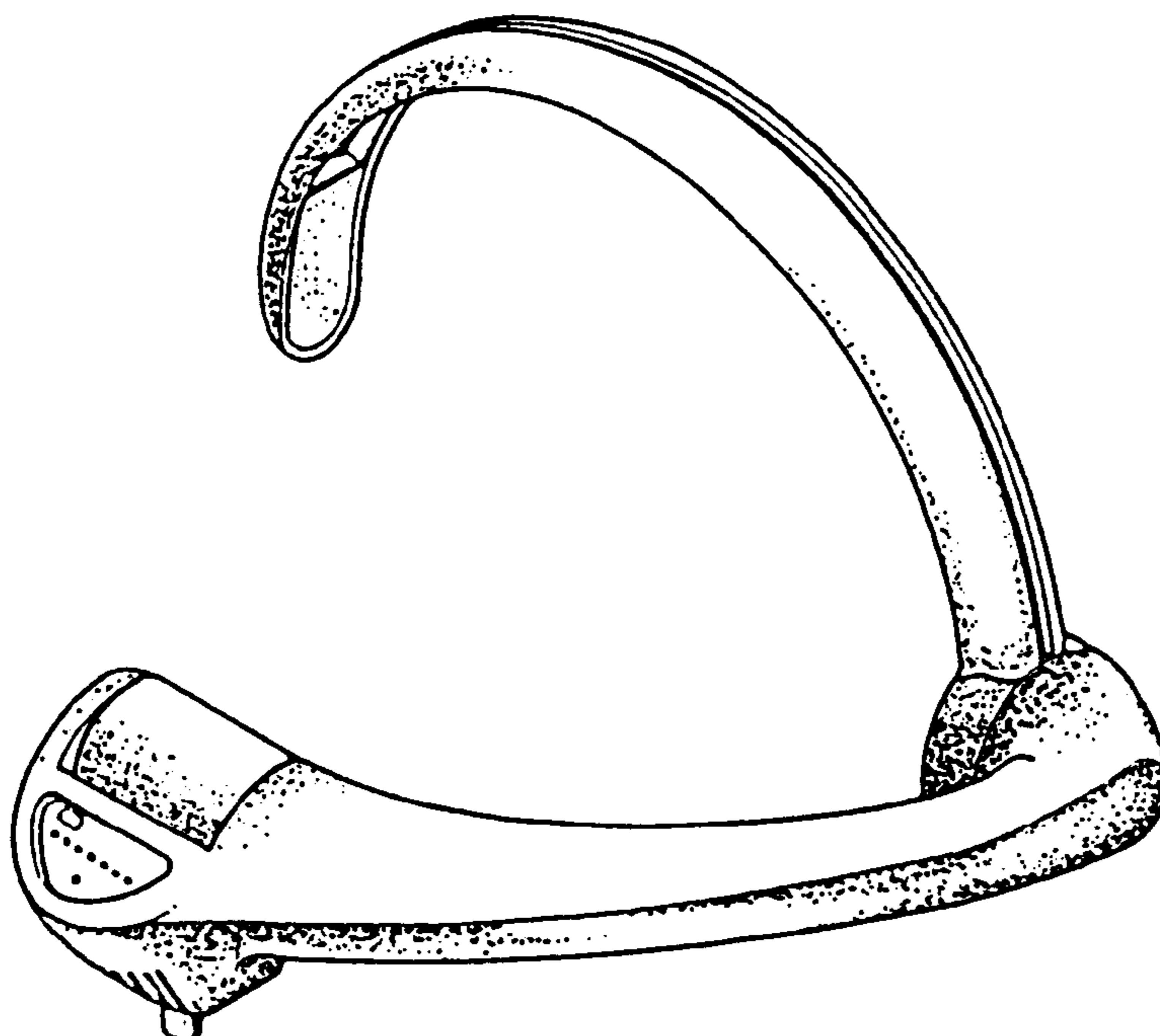

FIG. 1

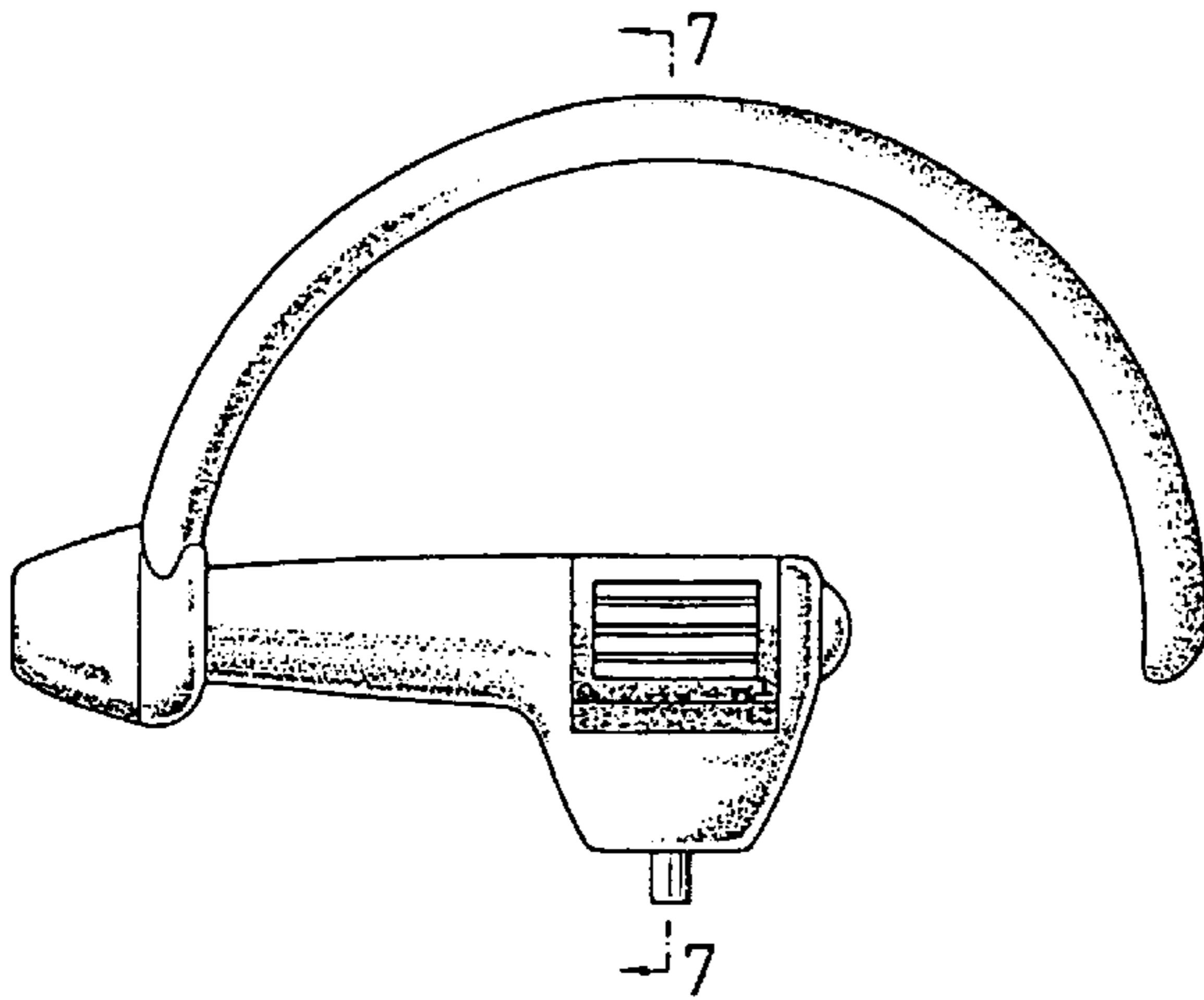

FIG. 2

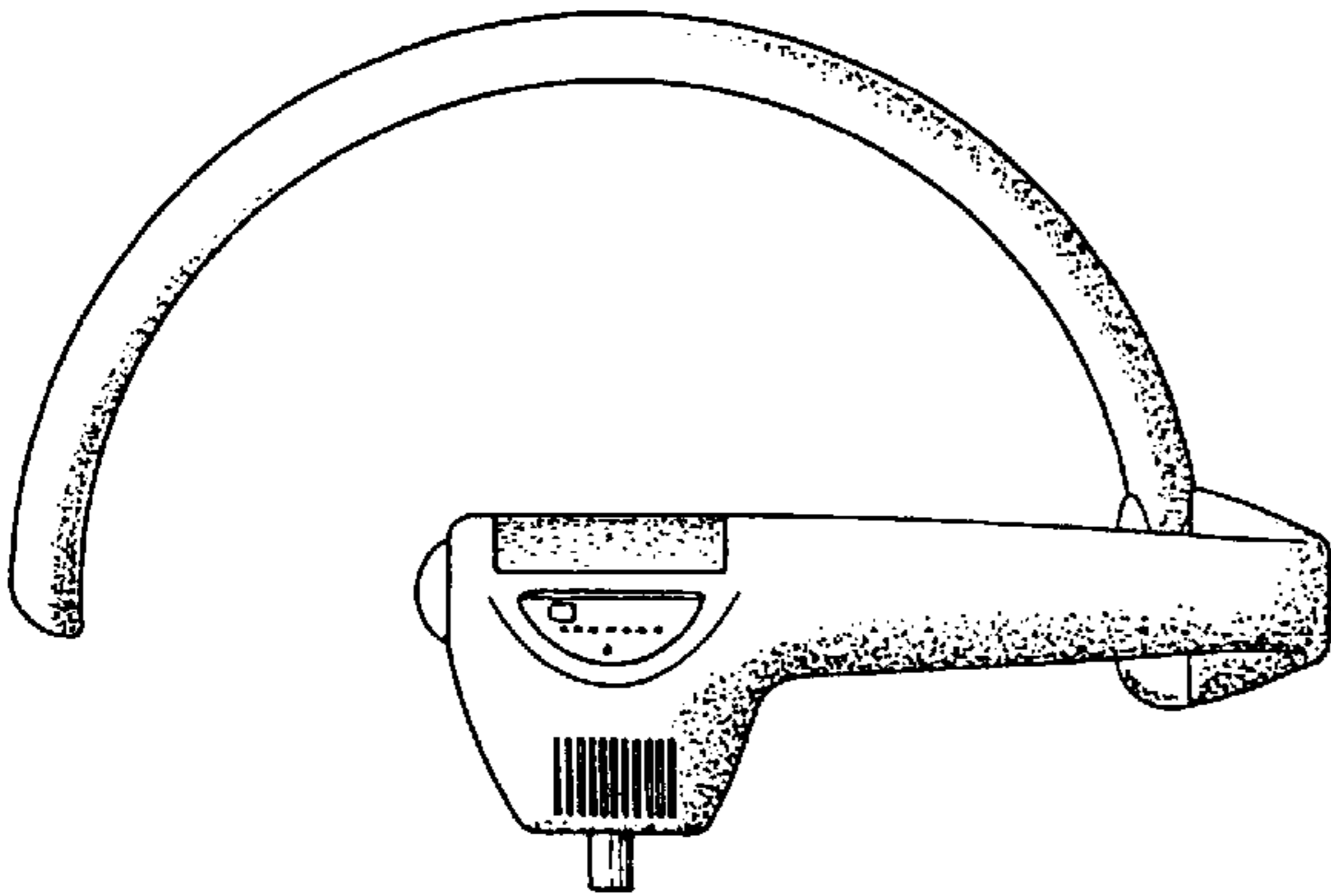

FIG. 3

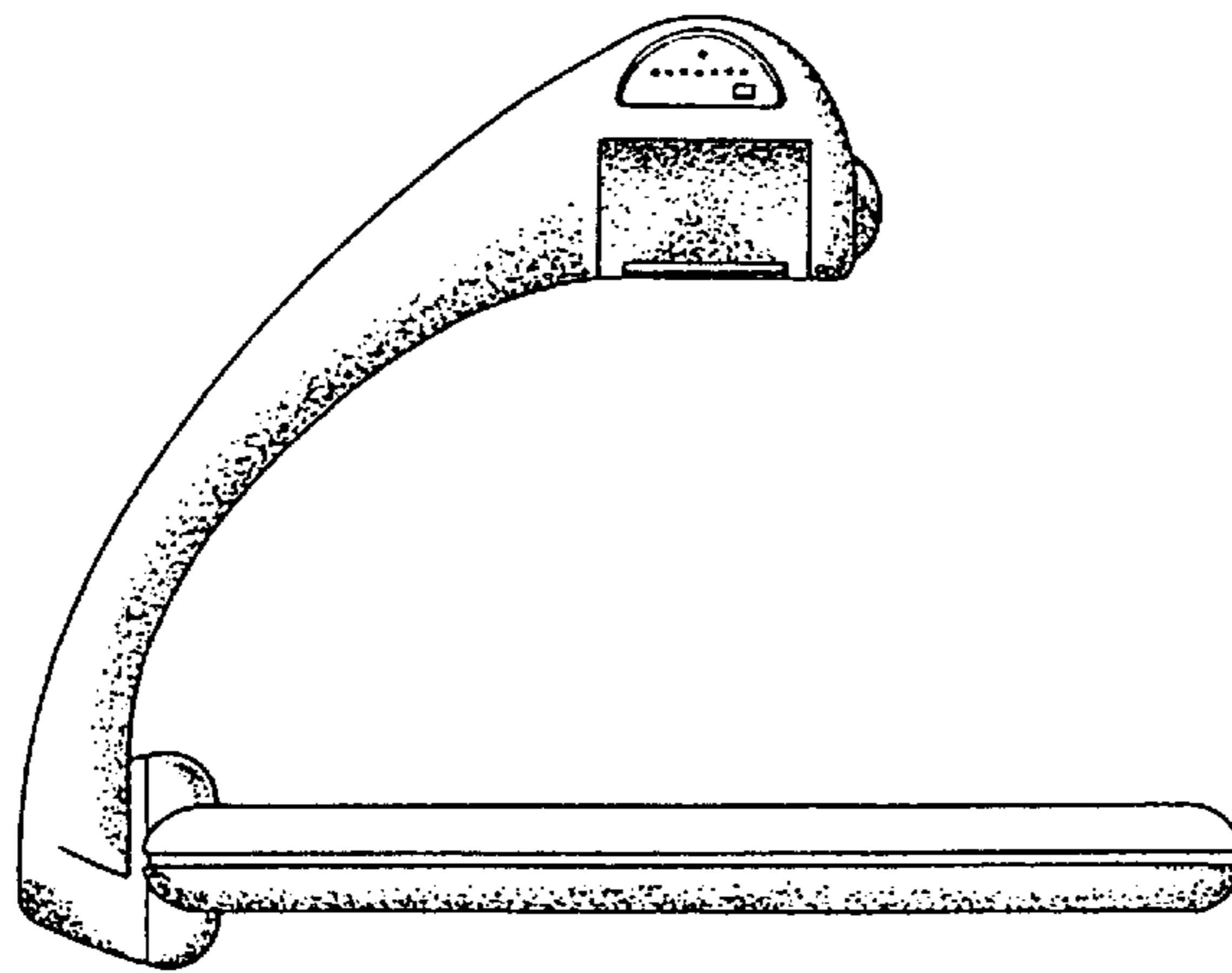

FIG. 4

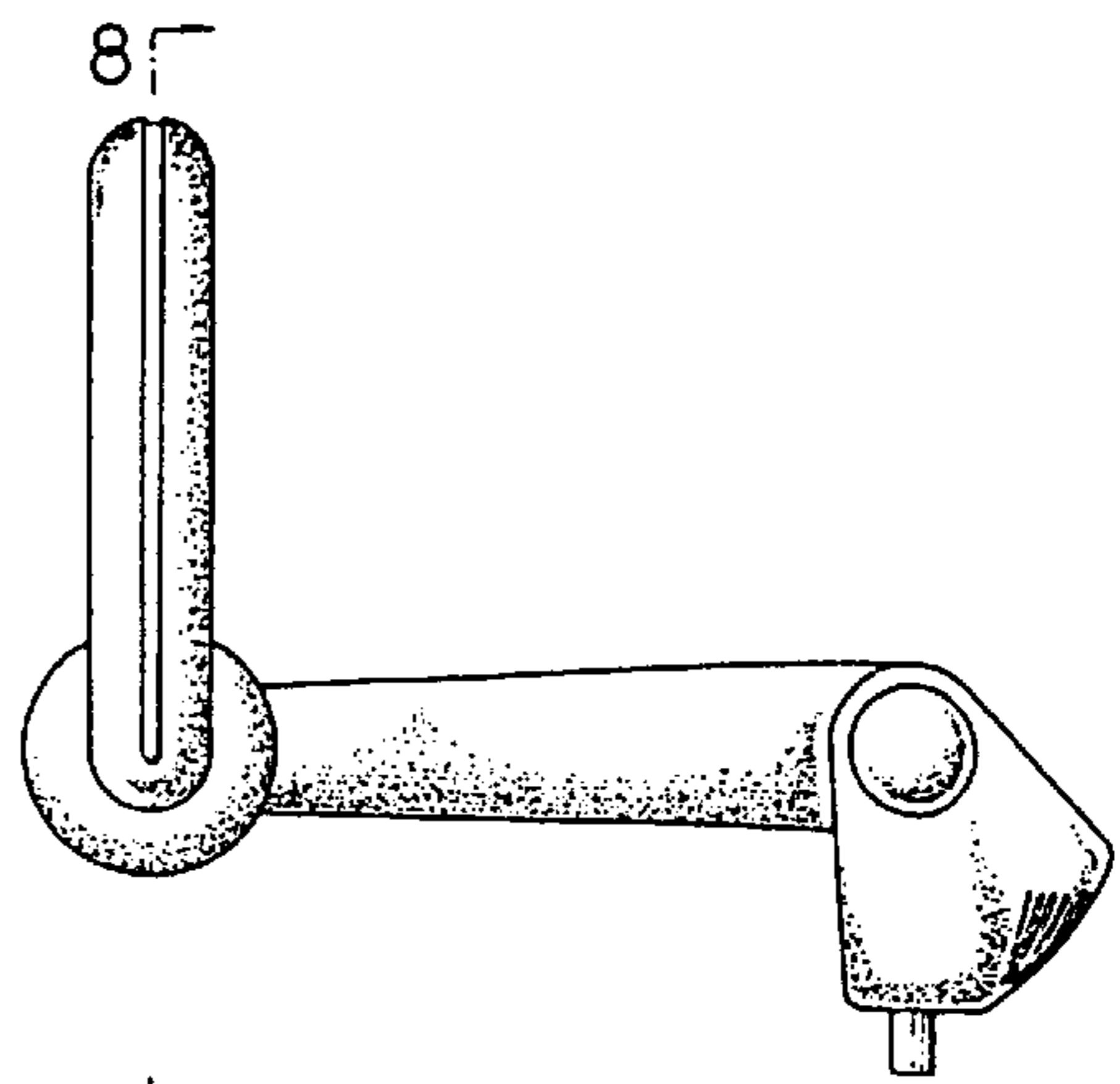

FIG. 5

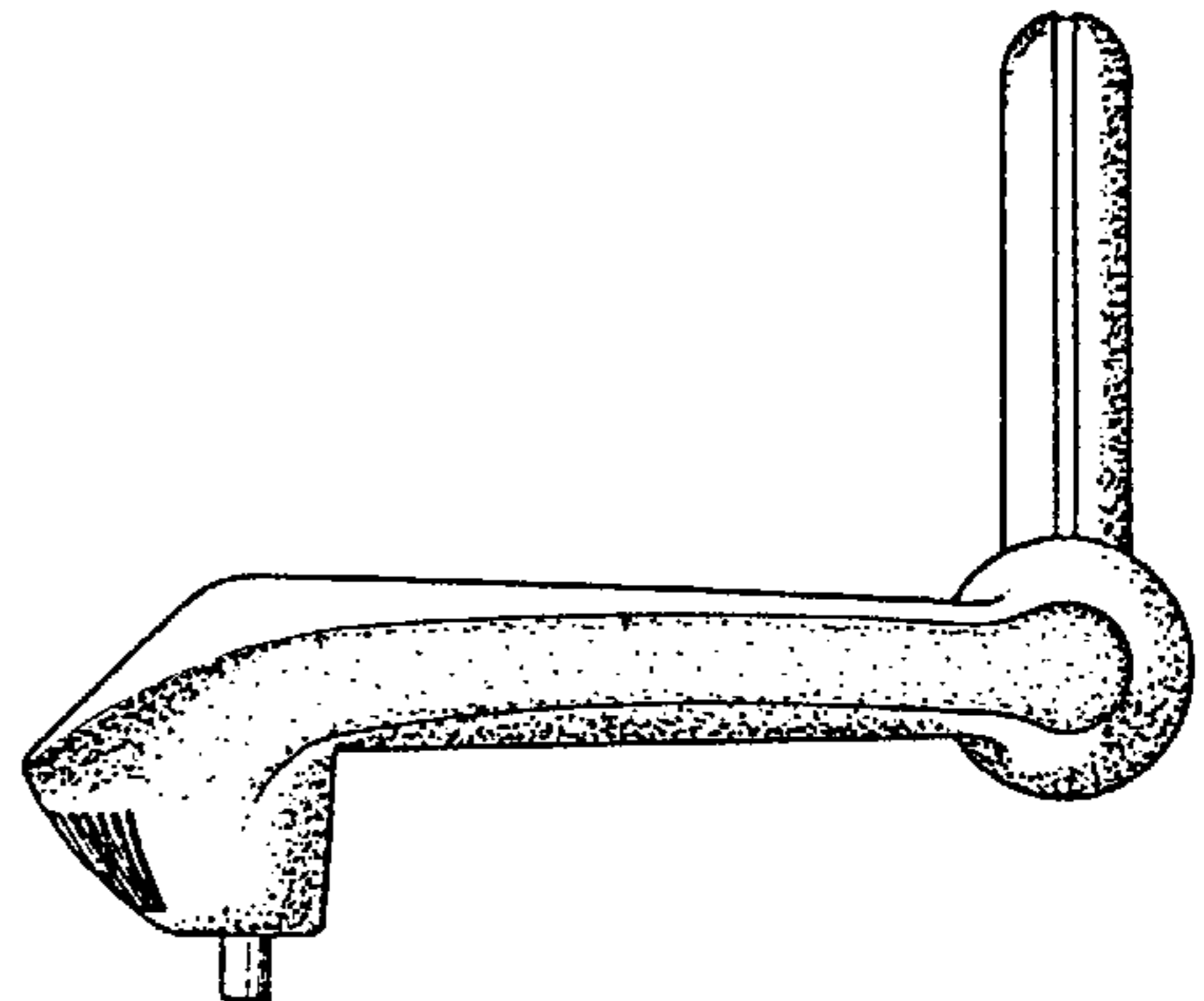

FIG. 6

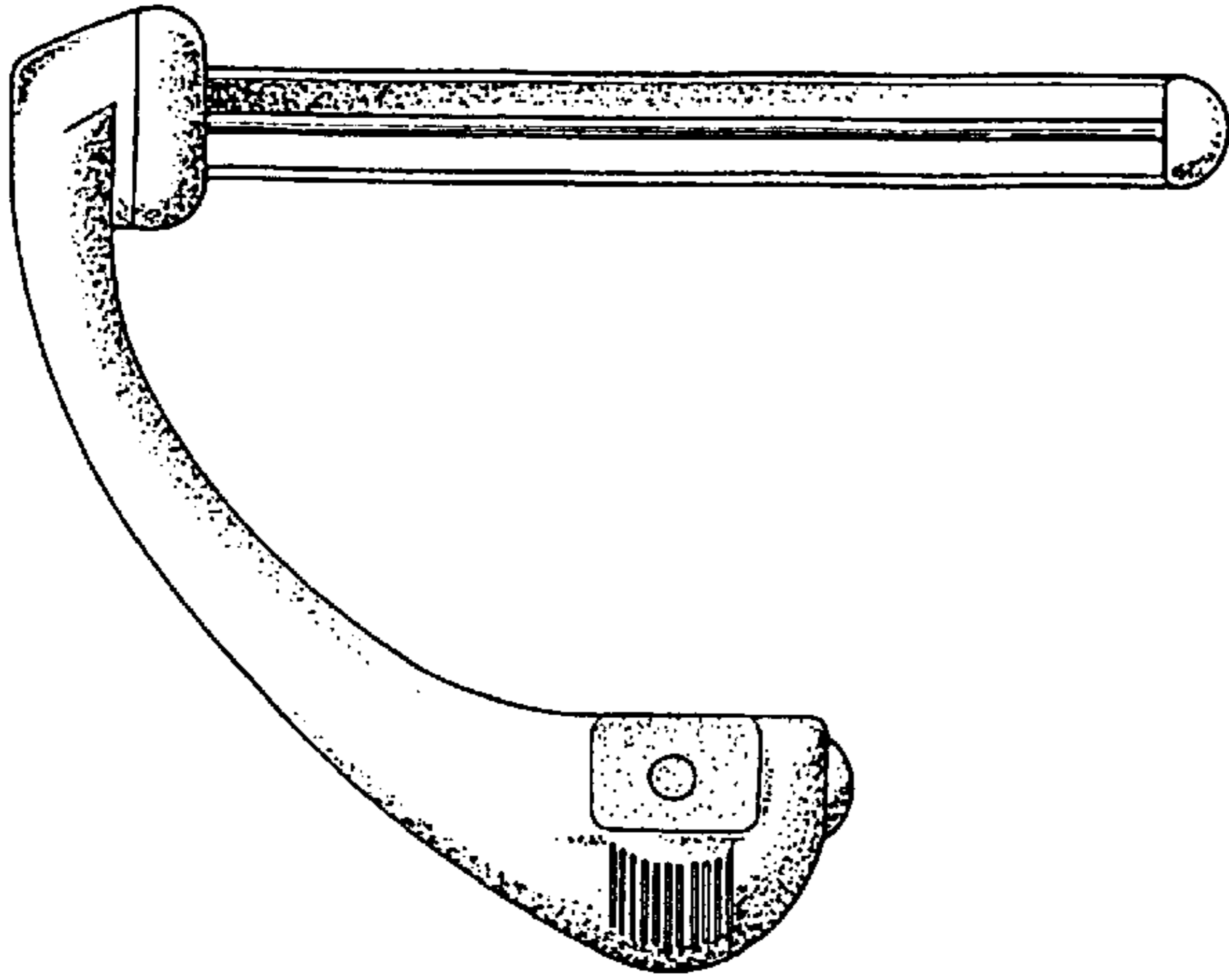

FIG. 9

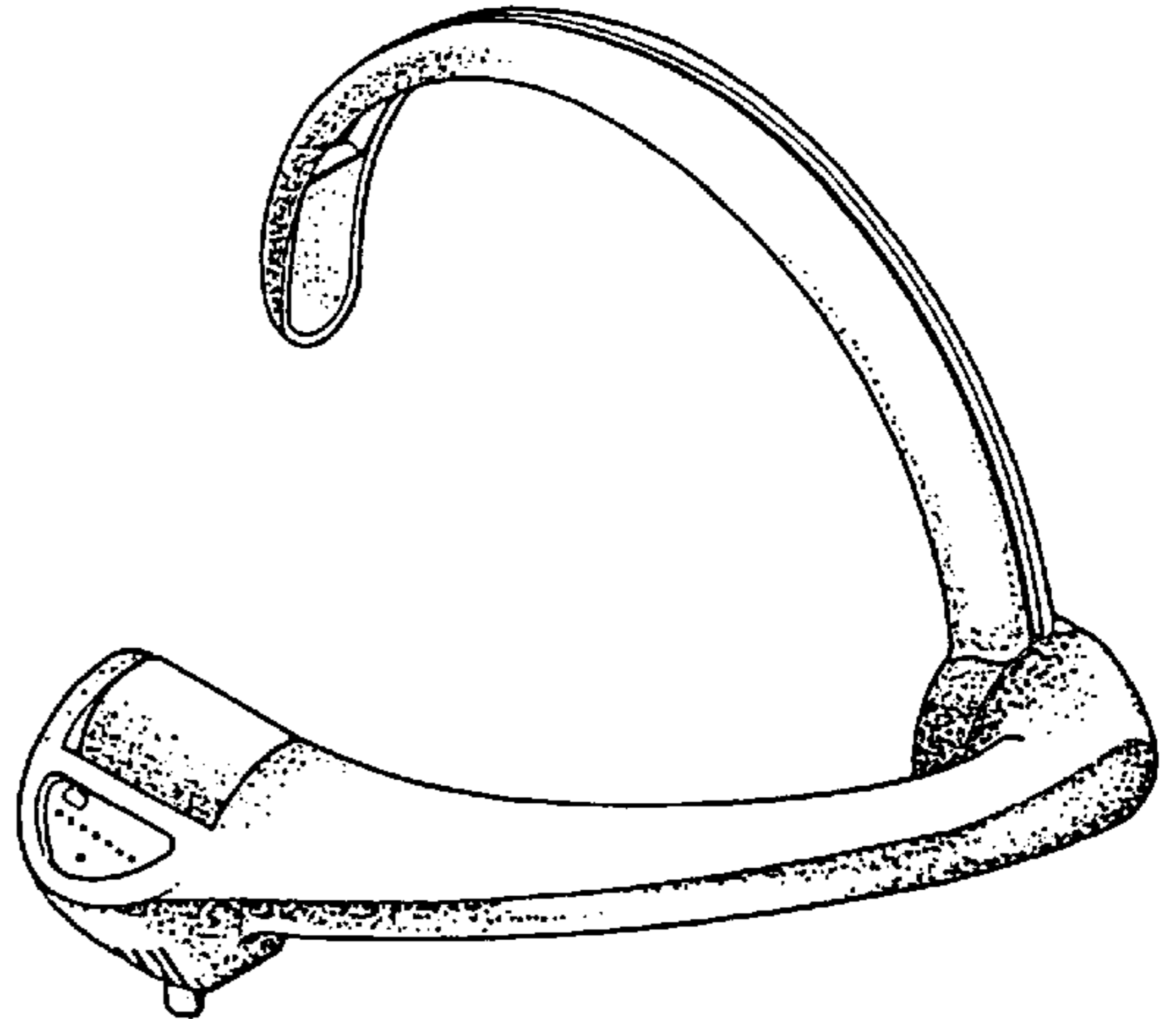

FIG. 7

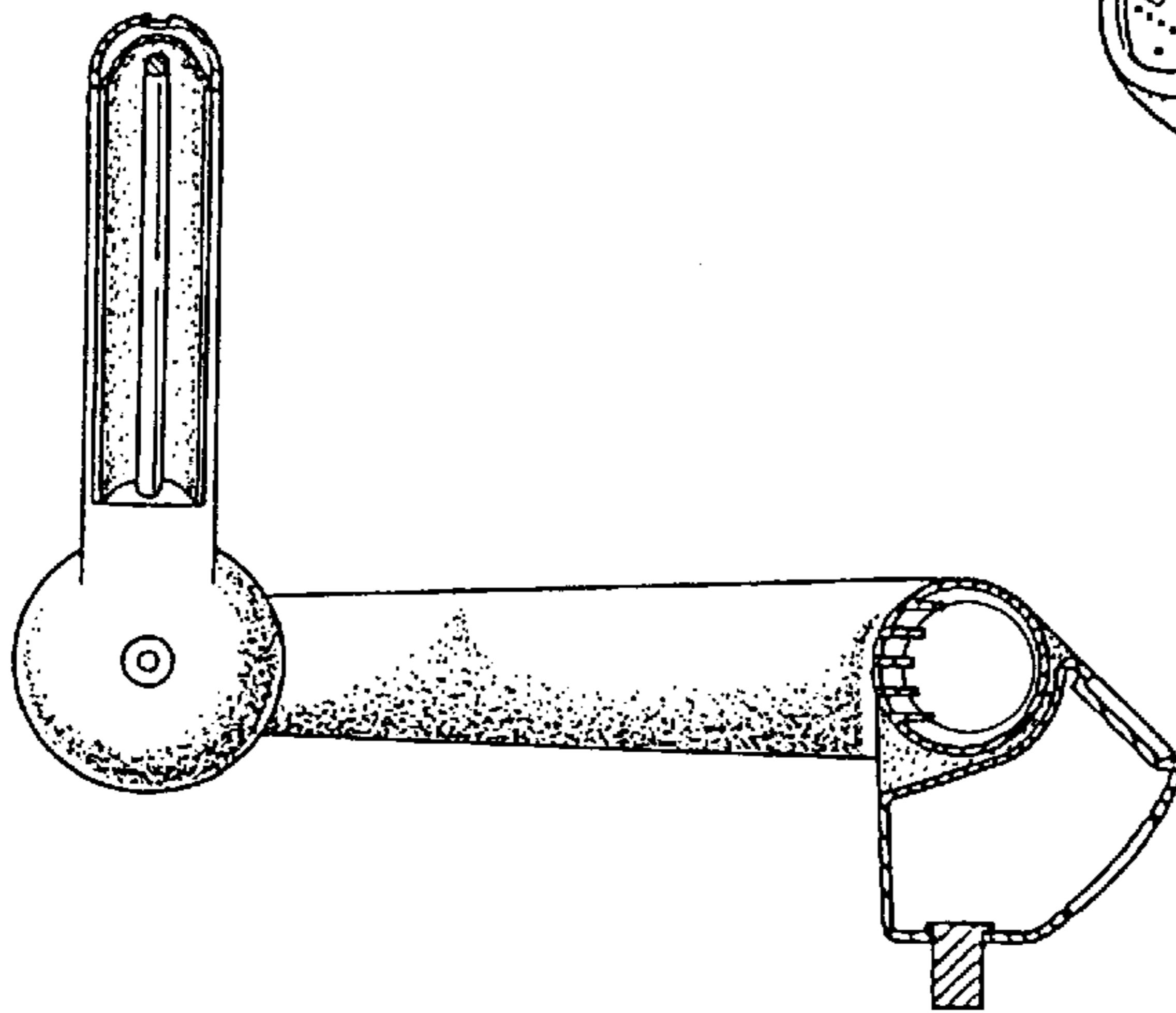

FIG. 8

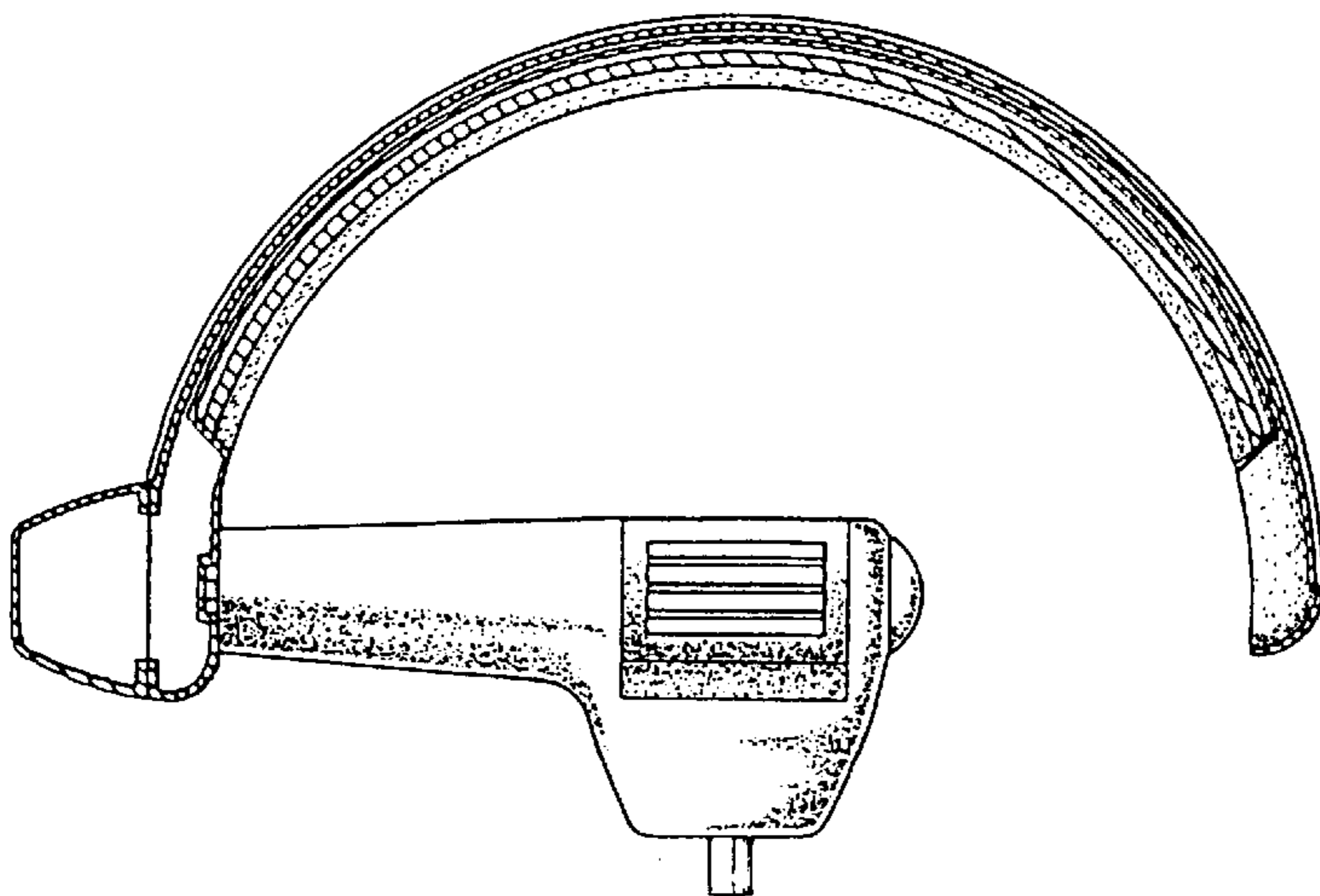

FIG. 10

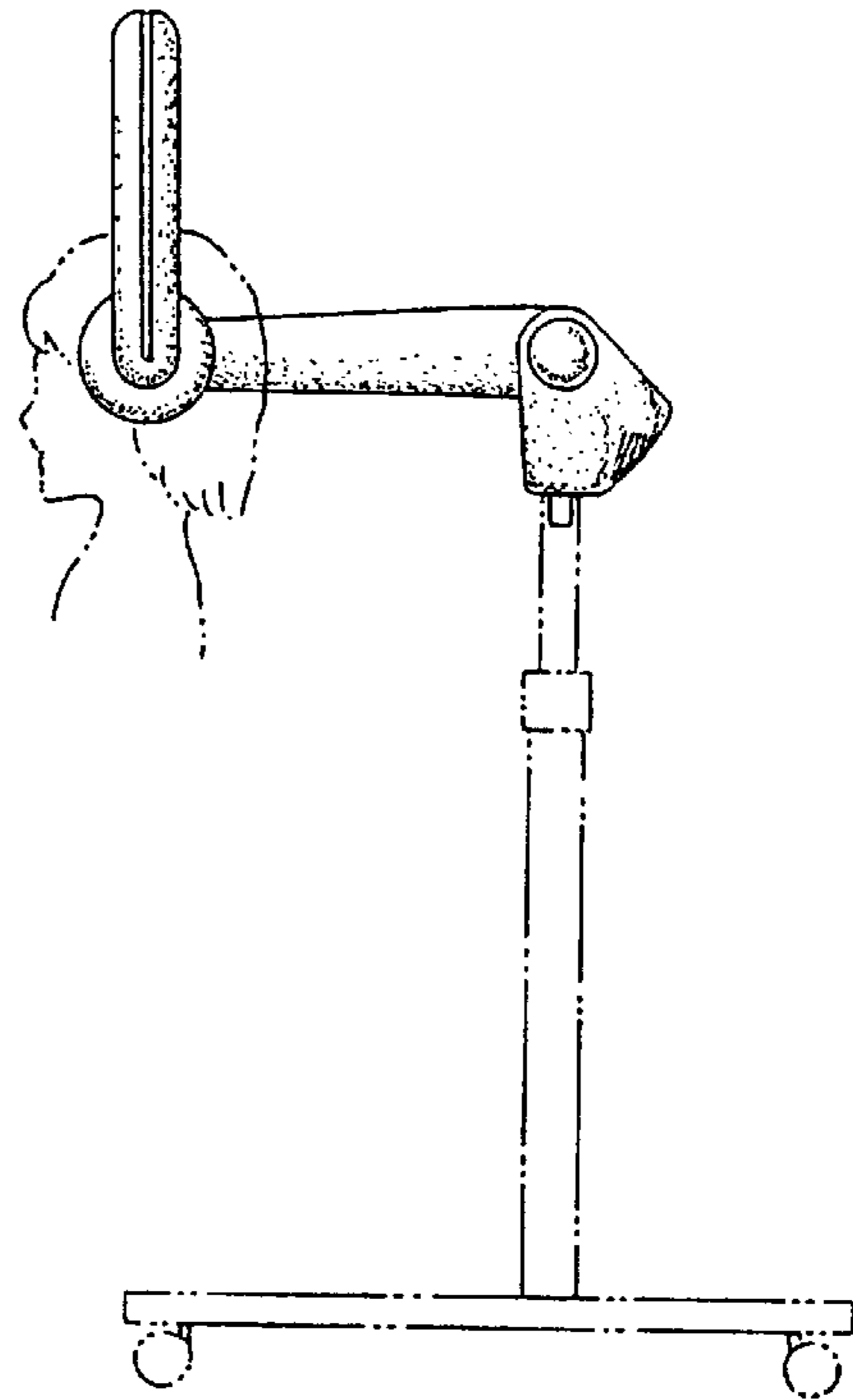

FIG. 11

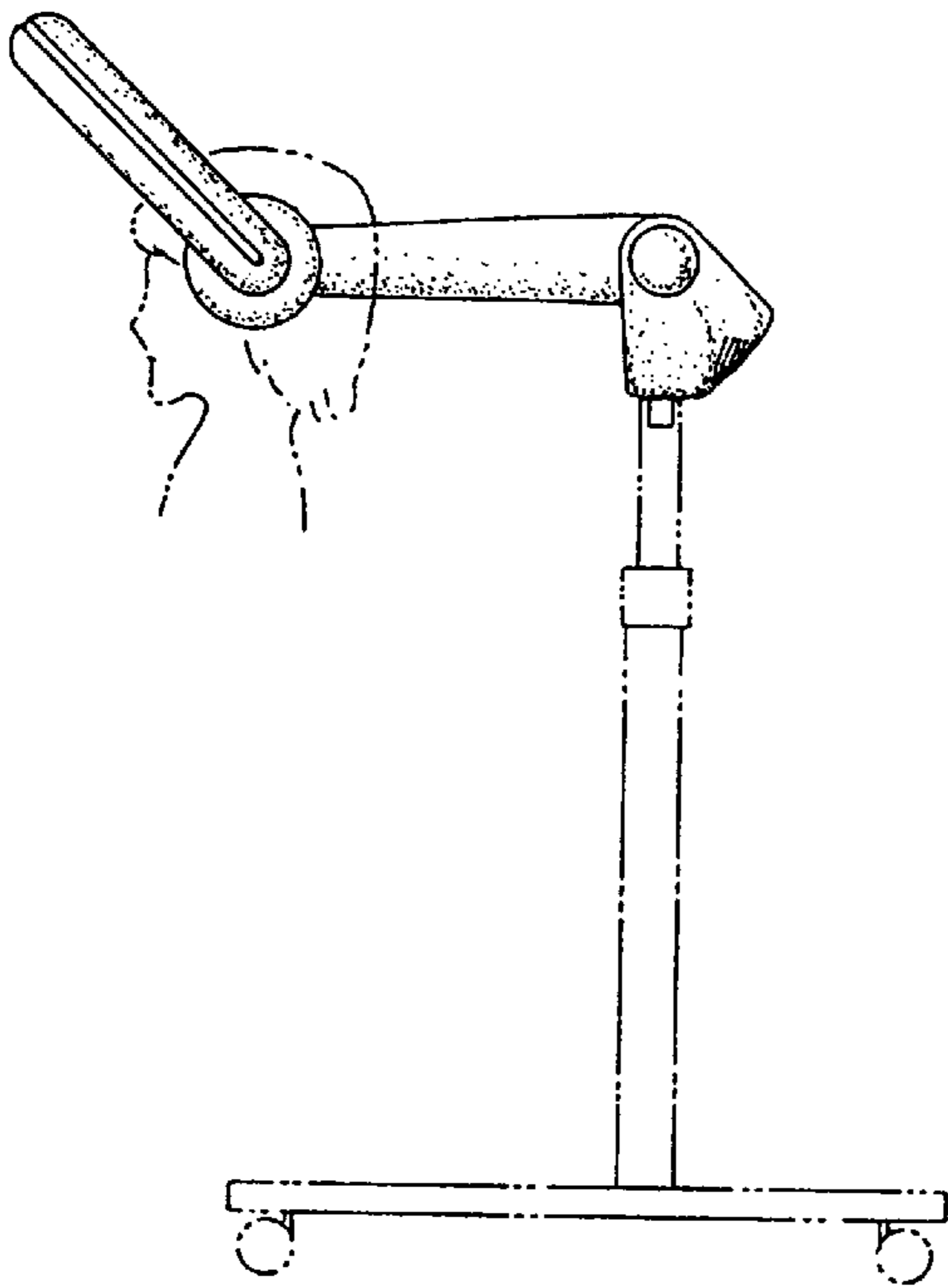

FIG. 12

