



US00D409302S

United States Patent [19]

[11] Patent Number: Des. 409,302

Zuege

[45] Date of Patent: ** May 4, 1999

[54] **COMBINED MOTOR HOUSING, SWITCH HOUSING AND BLADE IRONS UNIT FOR A CEILING FAN**

[75] Inventor: **Bradford C. Zuege**, Memphis, Tenn.

[73] Assignee: **Hunter Fan Company**, Memphis, Tenn.

[**] Term: **14 Years**

[21] Appl. No.: **29/091,022**

[22] Filed: **Jul. 22, 1998**

[51] **LOC (6) Cl.** **23-04**

[52] **U.S. Cl.** **D23/411; D23/377**

[58] **Field of Search** **D23/377, 379, D23/385, 411; 416/5, 210 R; 392/364; 364/96; D26/81-86, 88, 51, 59**

[56] References Cited

U.S. PATENT DOCUMENTS

- D. 326,905 6/1992 Scofield D23/411
- D. 358,878 5/1995 Tsuji D23/377

OTHER PUBLICATIONS

Hunter Fan Co. Catalog Sheet, Copyright 1997, 52" Coastal Breeze.

Primary Examiner—Lisa Lichtenstein

Attorney, Agent, or Firm—Baker, Donelson, Bearman & Caldwell

[57] CLAIM

The ornamental design for a combined motor housing, switch housing and blade irons unit for a ceiling fan, as shown and described.

DESCRIPTION

FIG. 1 is a perspective view of a combined motor housing, switch housing and blade irons unit for a ceiling fan showing my new design;

FIG. 2 is a perspective view of the design shown in FIG. 1 with the environmental structure removed therefrom;

FIG. 3 is a front view thereof;

FIG. 4 is a right-side view thereof;

FIG. 5 is a rear view thereof;

FIG. 6 is a left-side view thereof;

FIG. 7 is a top view thereof;

FIG. 8 is a bottom view thereof;

FIG. 9 is a perspective view of a second embodiment of the design shown in FIGS. 1-8;

FIG. 10 is a front view of FIG. 9;

FIG. 11 is a right-side view of FIG. 9;

FIG. 12 is a rear view of FIG. 9;

FIG. 13 is a left-side view of FIG. 9; and,

FIG. 14 is a top view of FIG. 9, the bottom view being identical to the bottom view illustrated in FIG. 8.

The broken-line showing of environmental structure in FIG. 1 is for illustrative purposes only and forms no part of the claimed design.

1 Claim, 14 Drawing Sheets

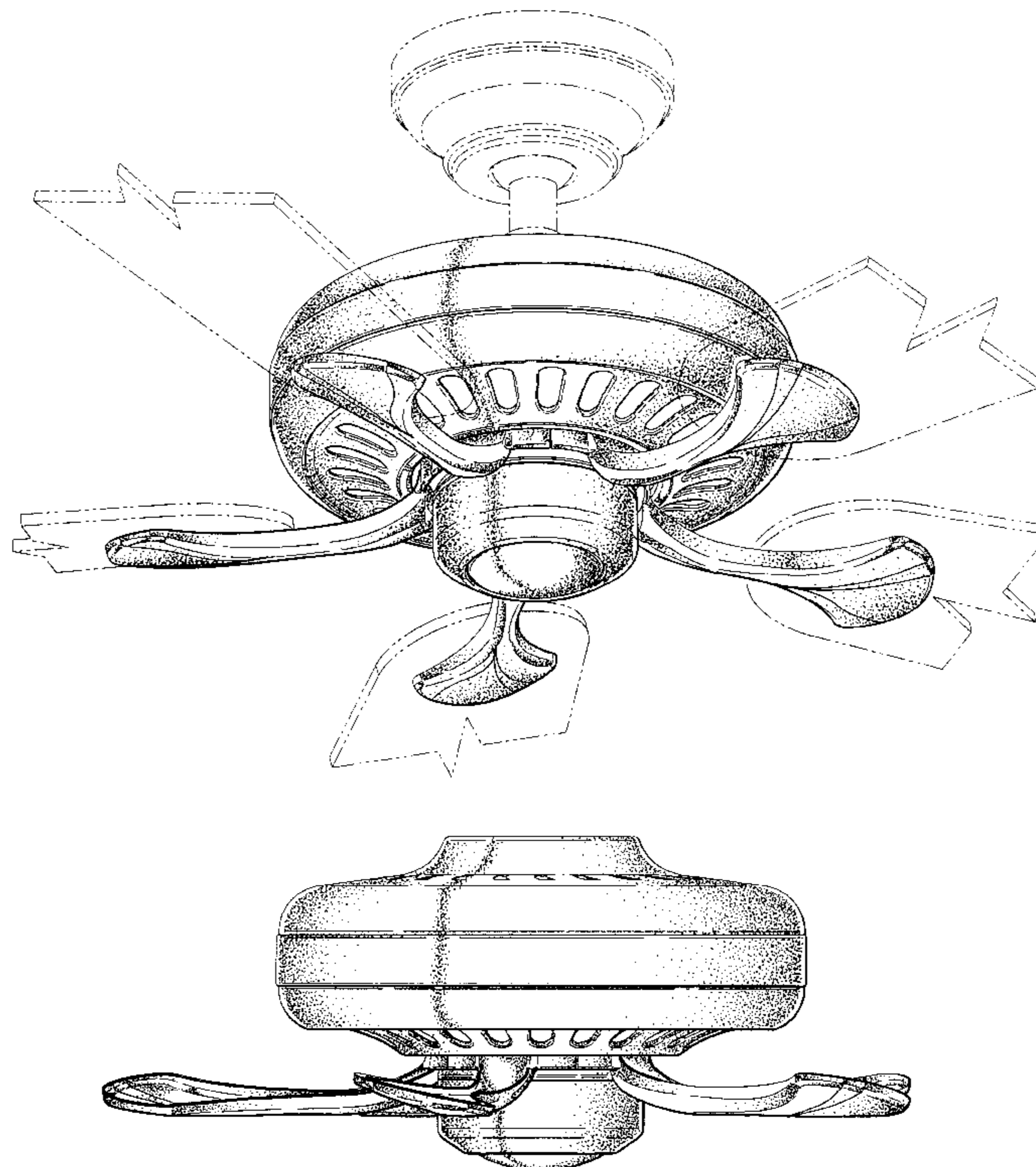

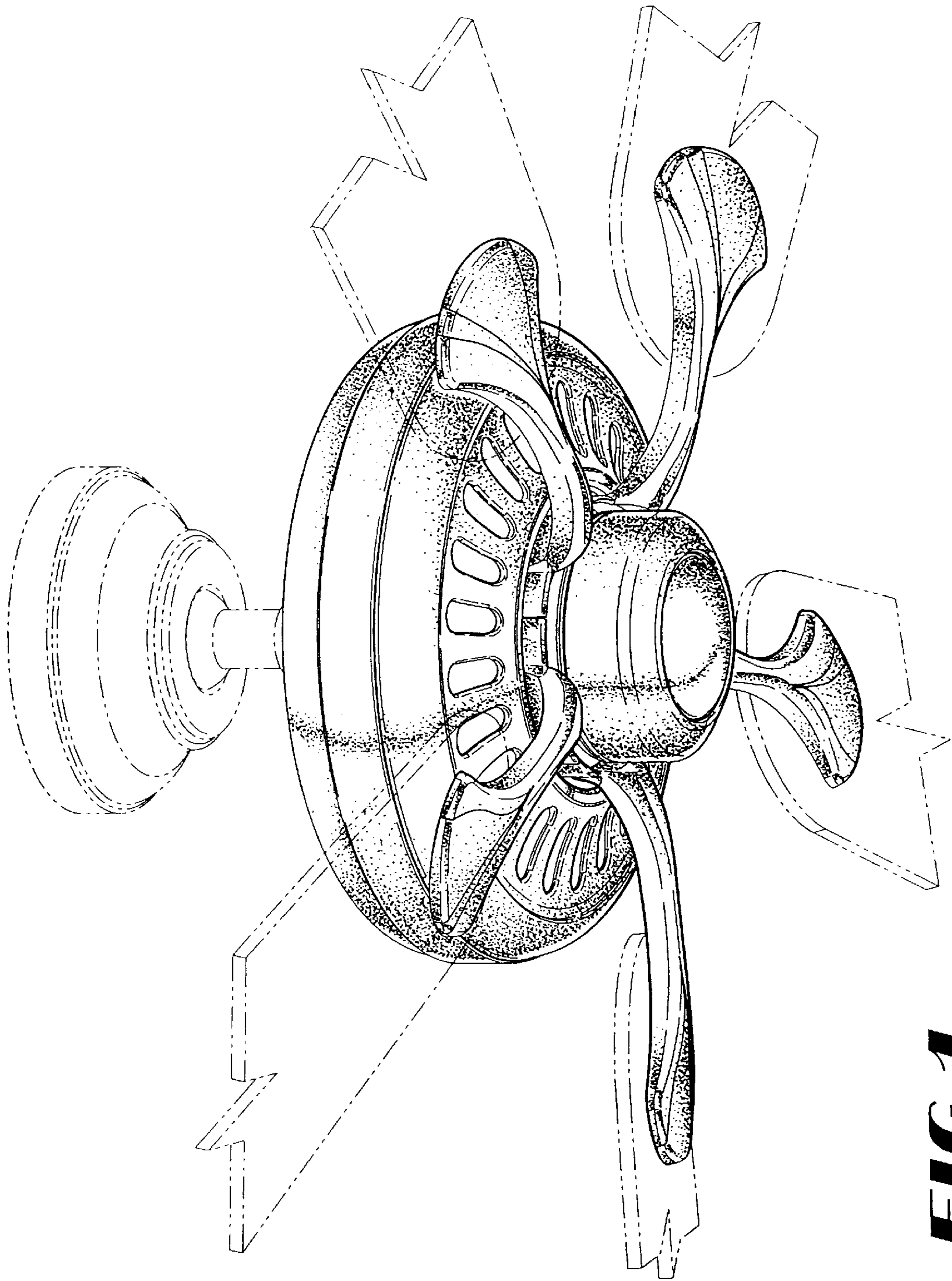

FIG 1

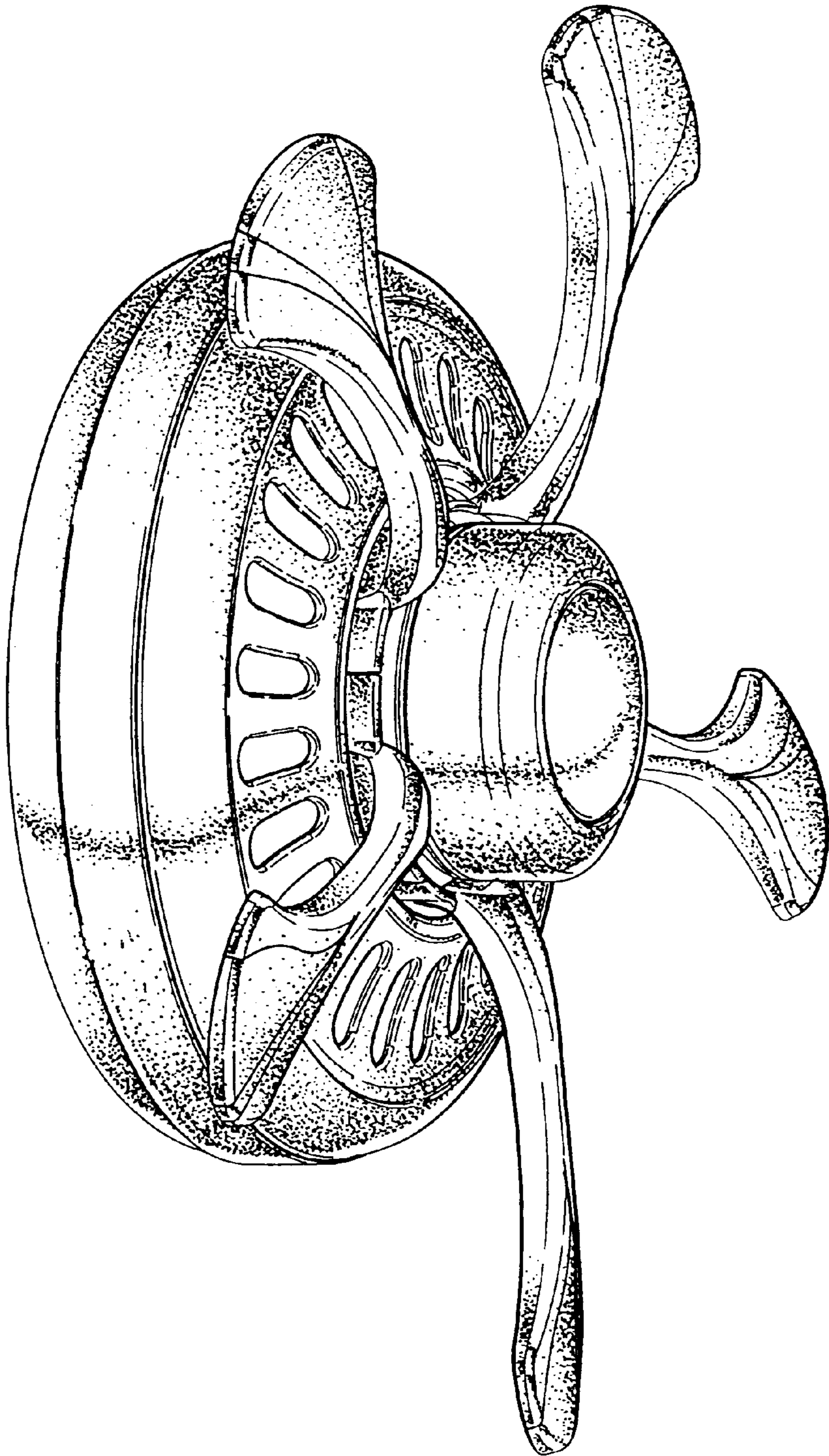

FIG 2

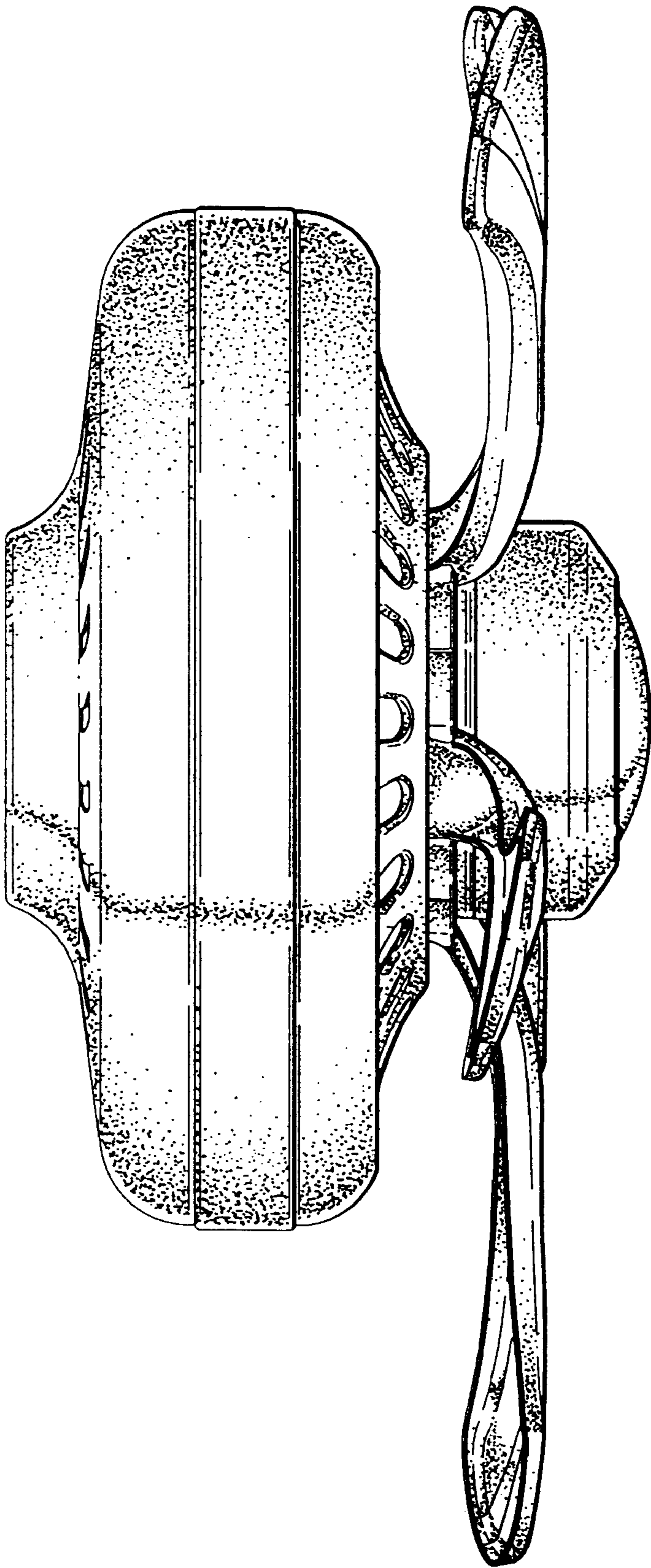

FIG 3

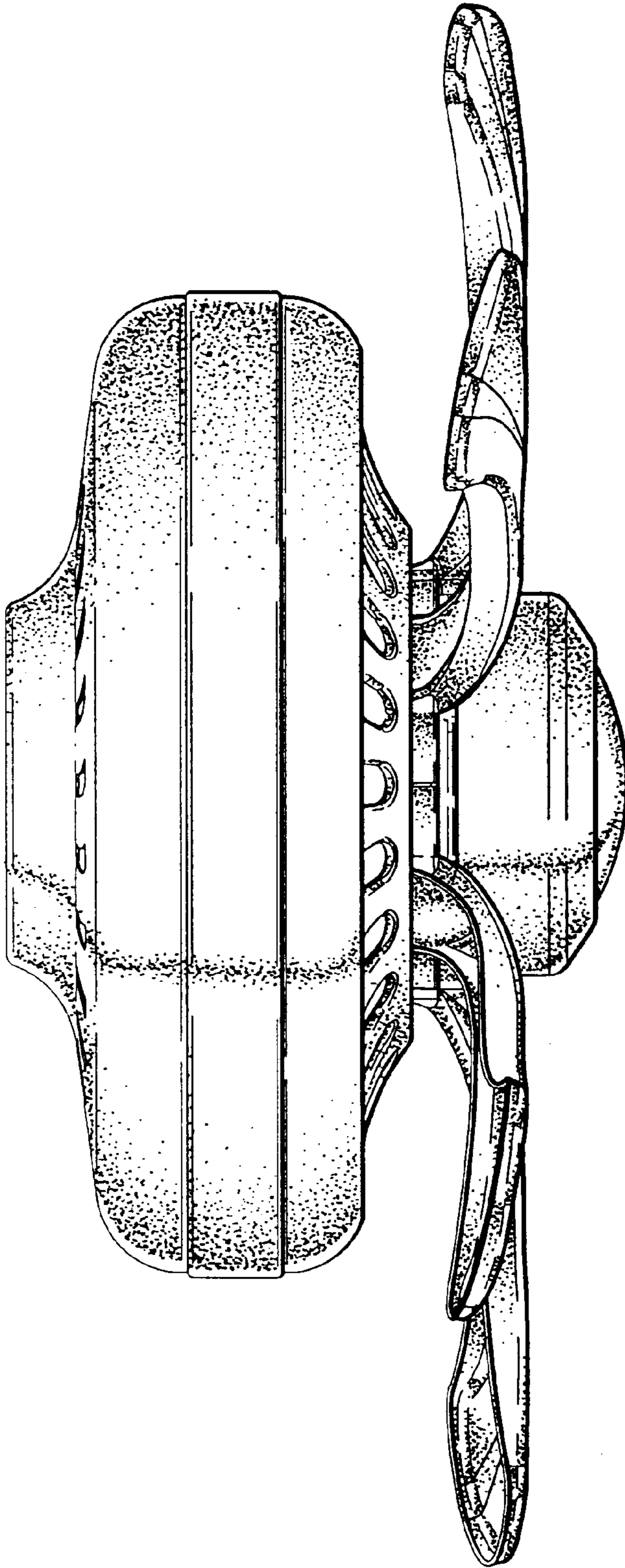

FIG 4

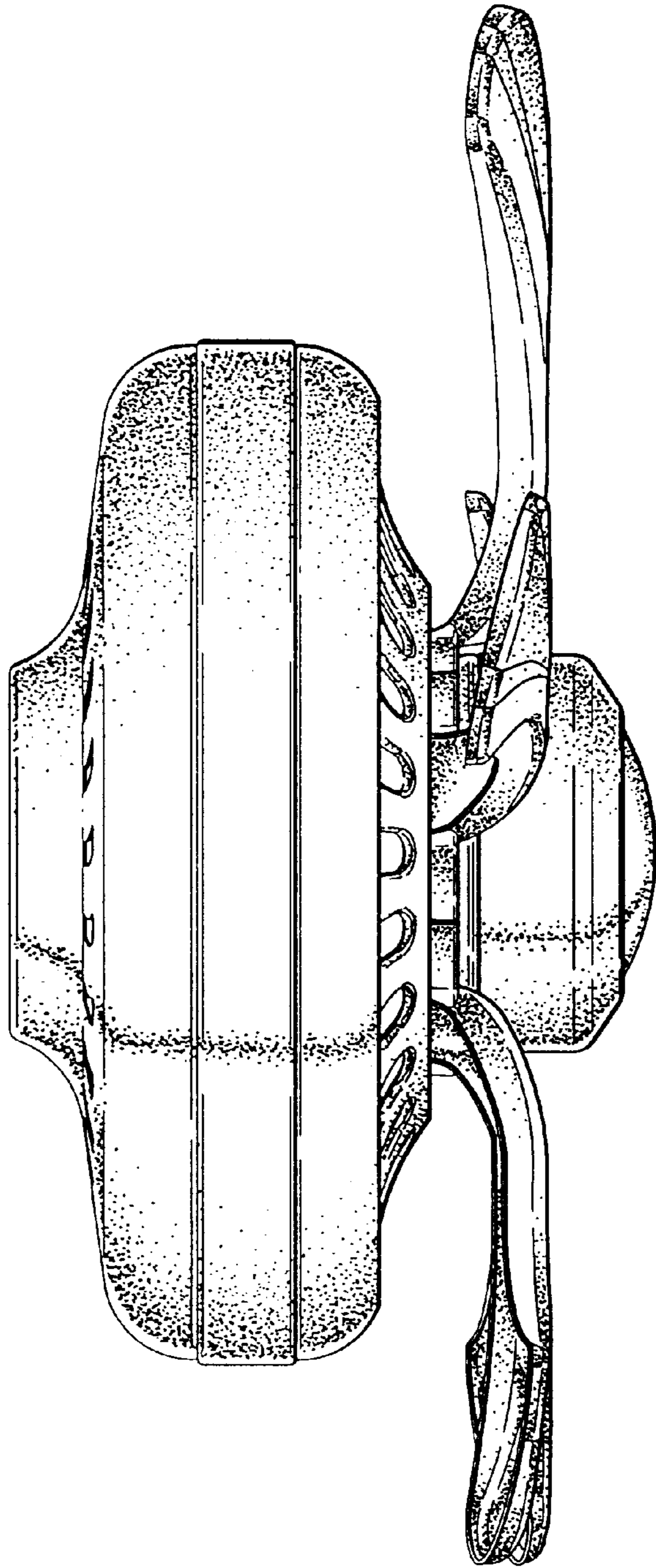

FIG 5

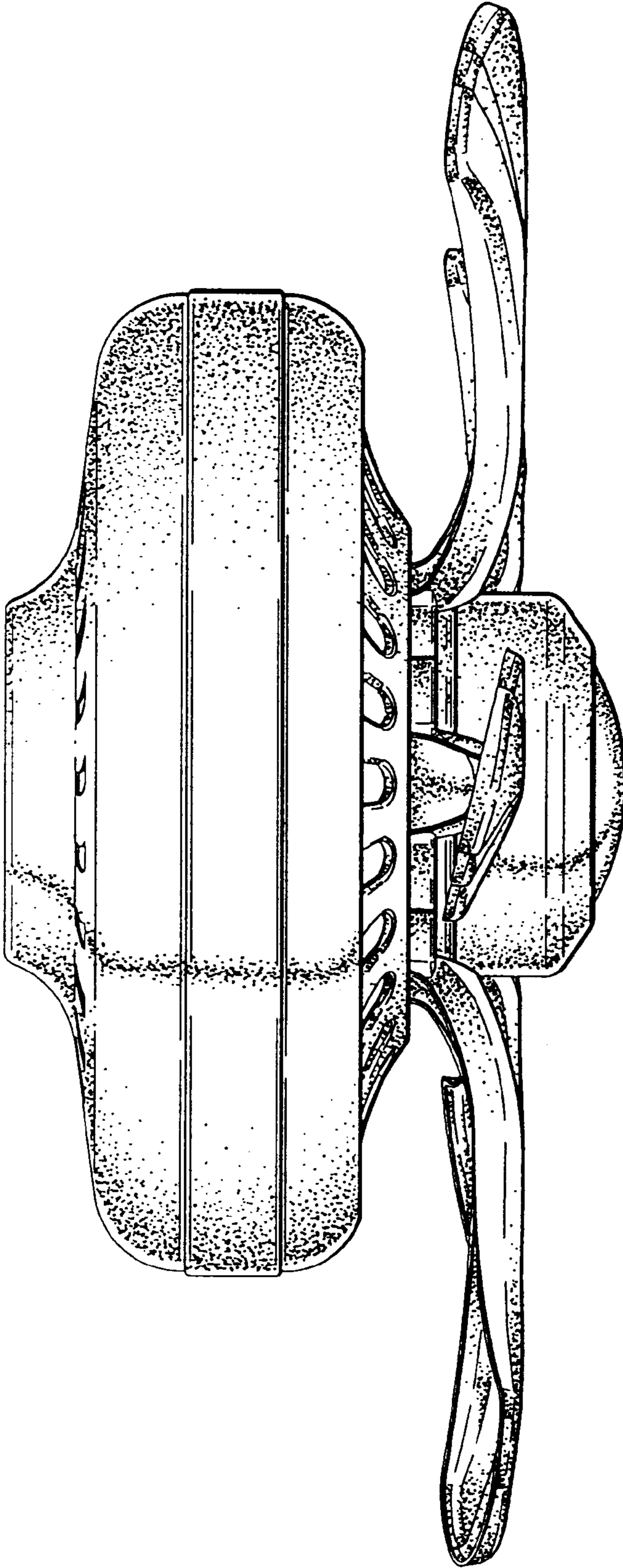

FIG 6

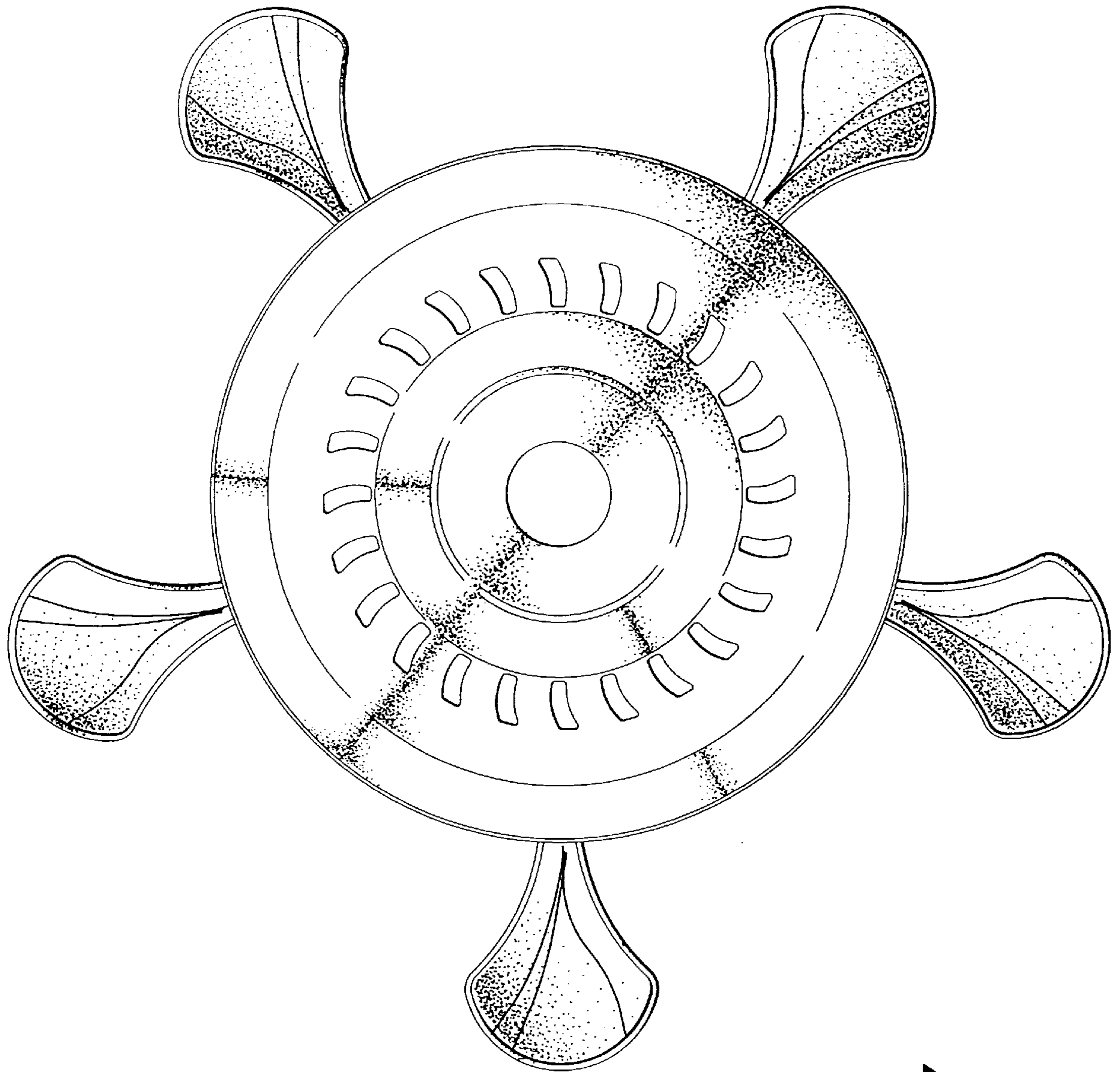

FIG 7

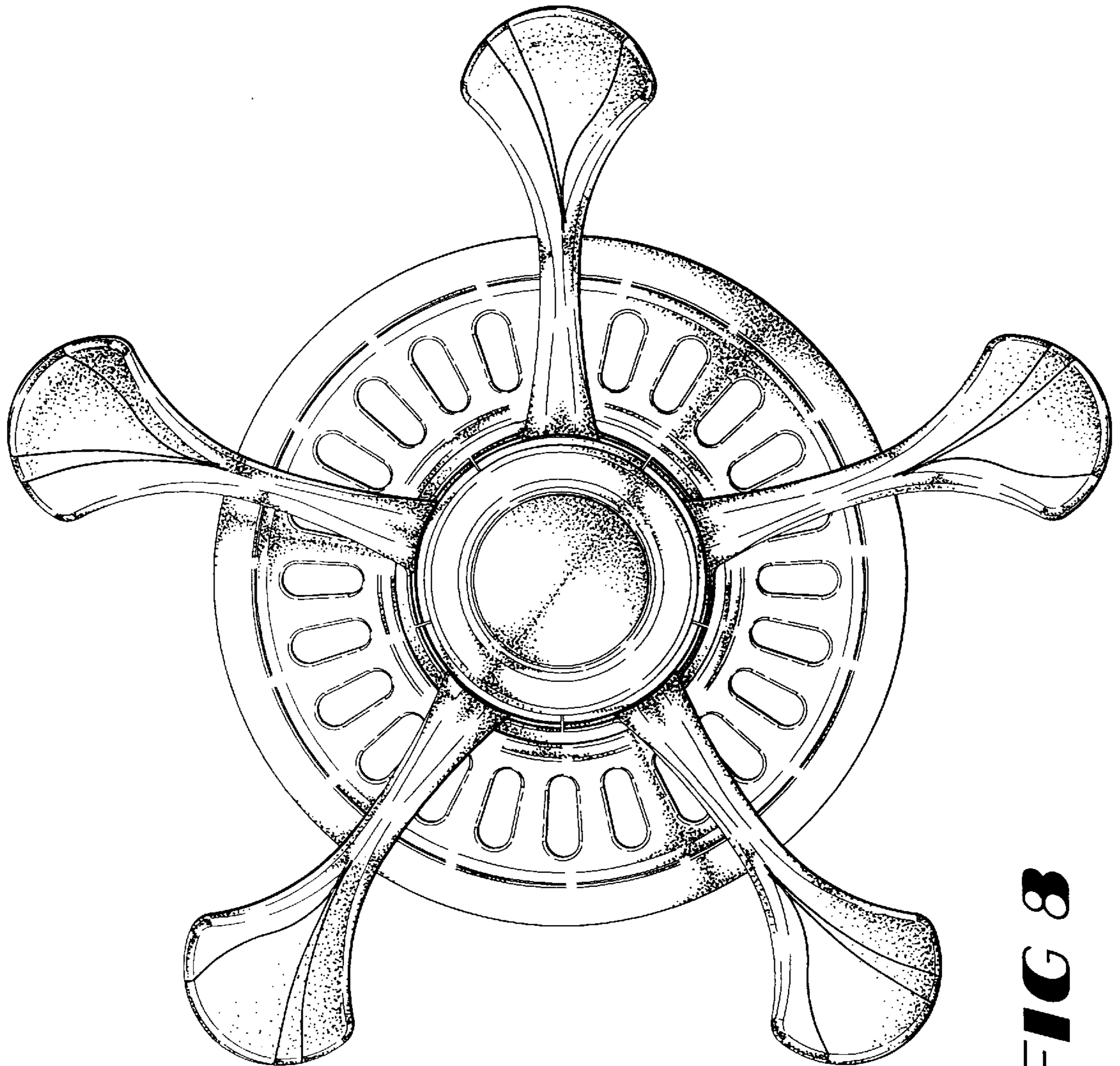

FIG 8

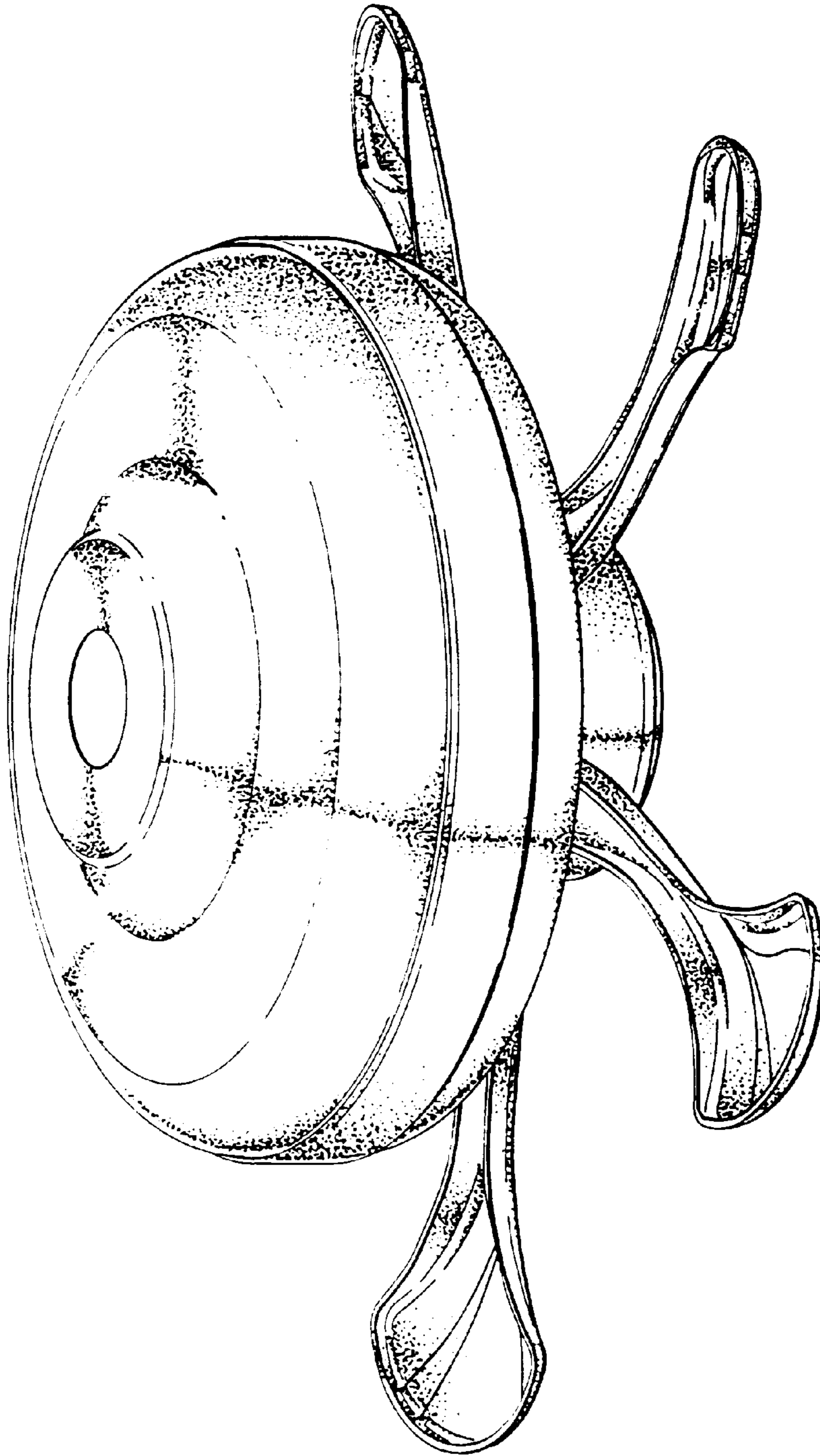

FIG 9

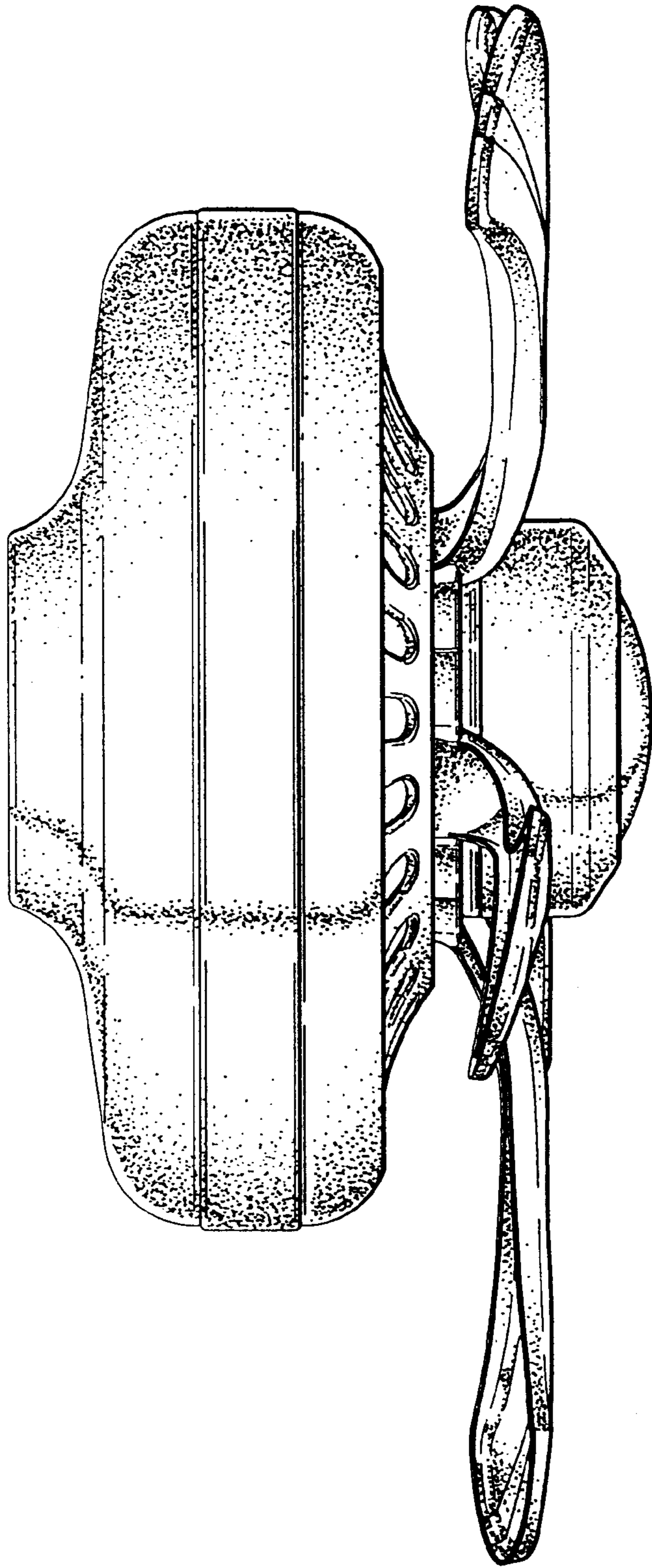

FIG 10

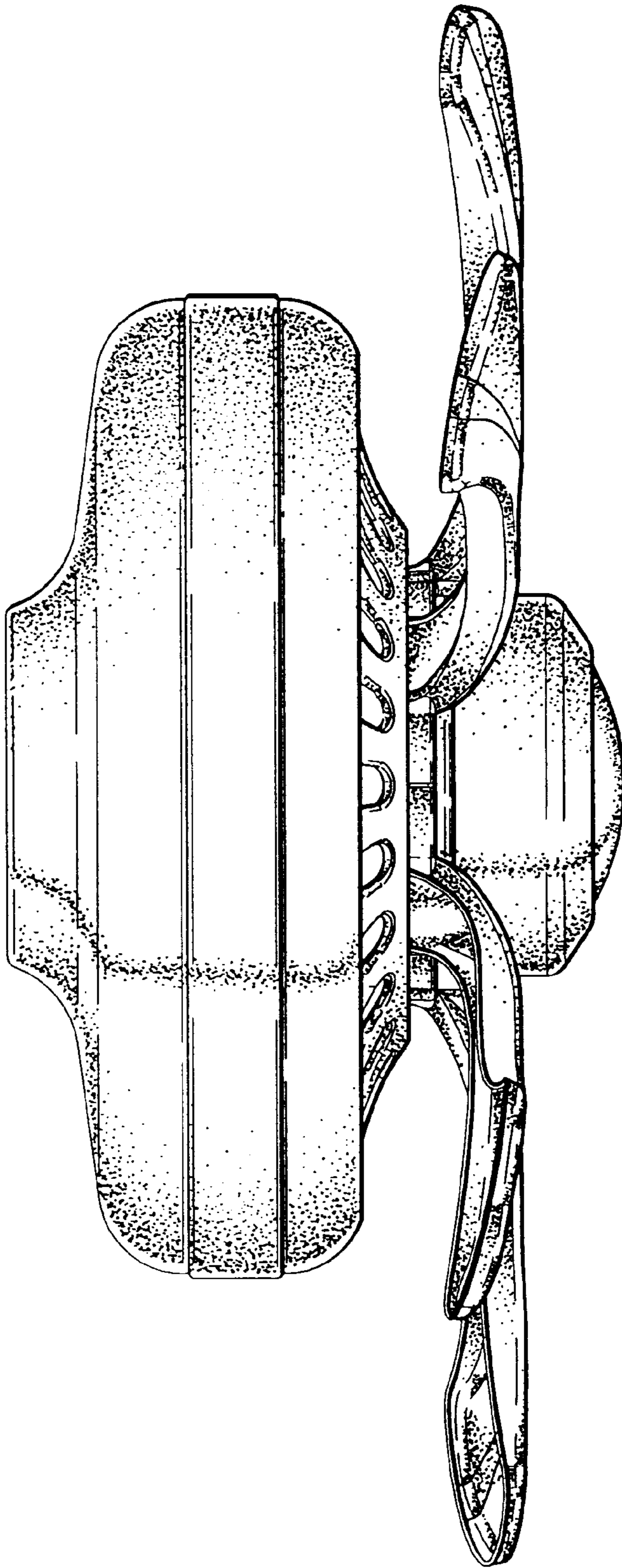

FIG 11

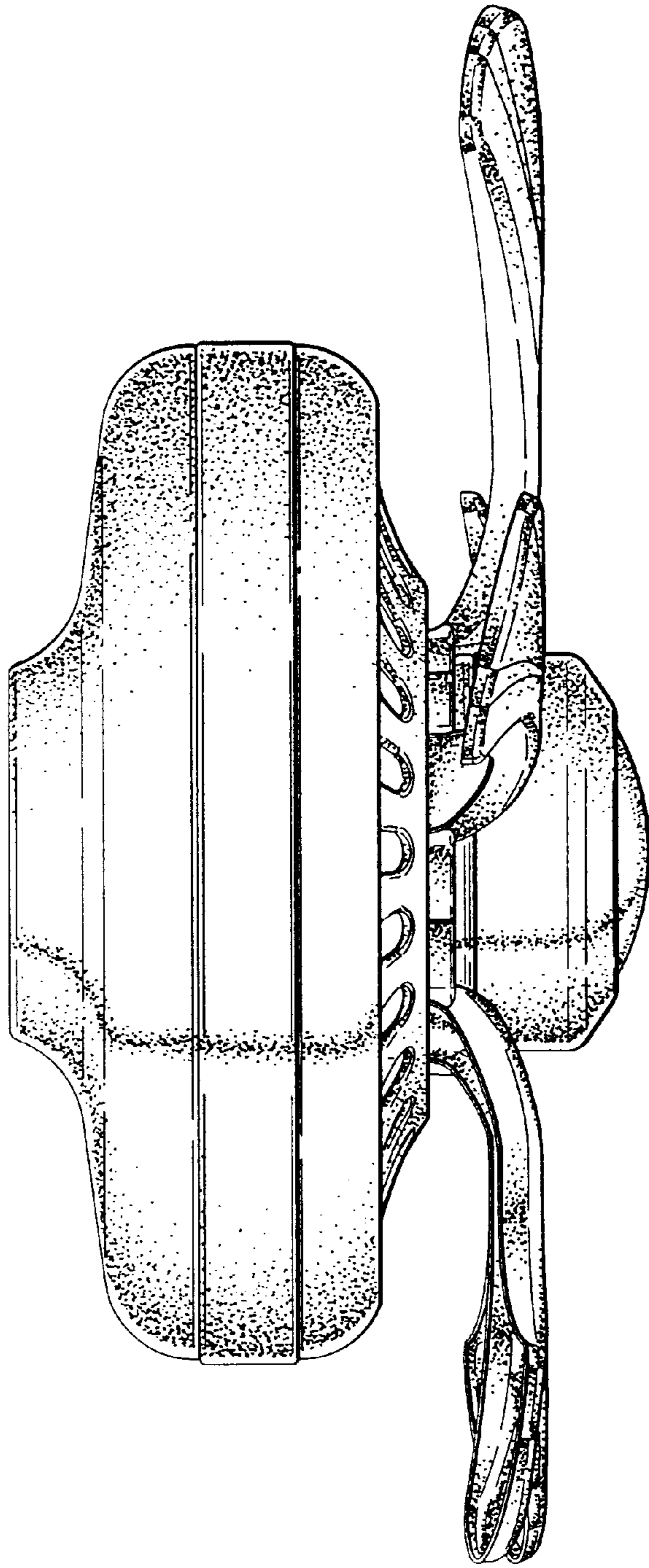

FIG 12

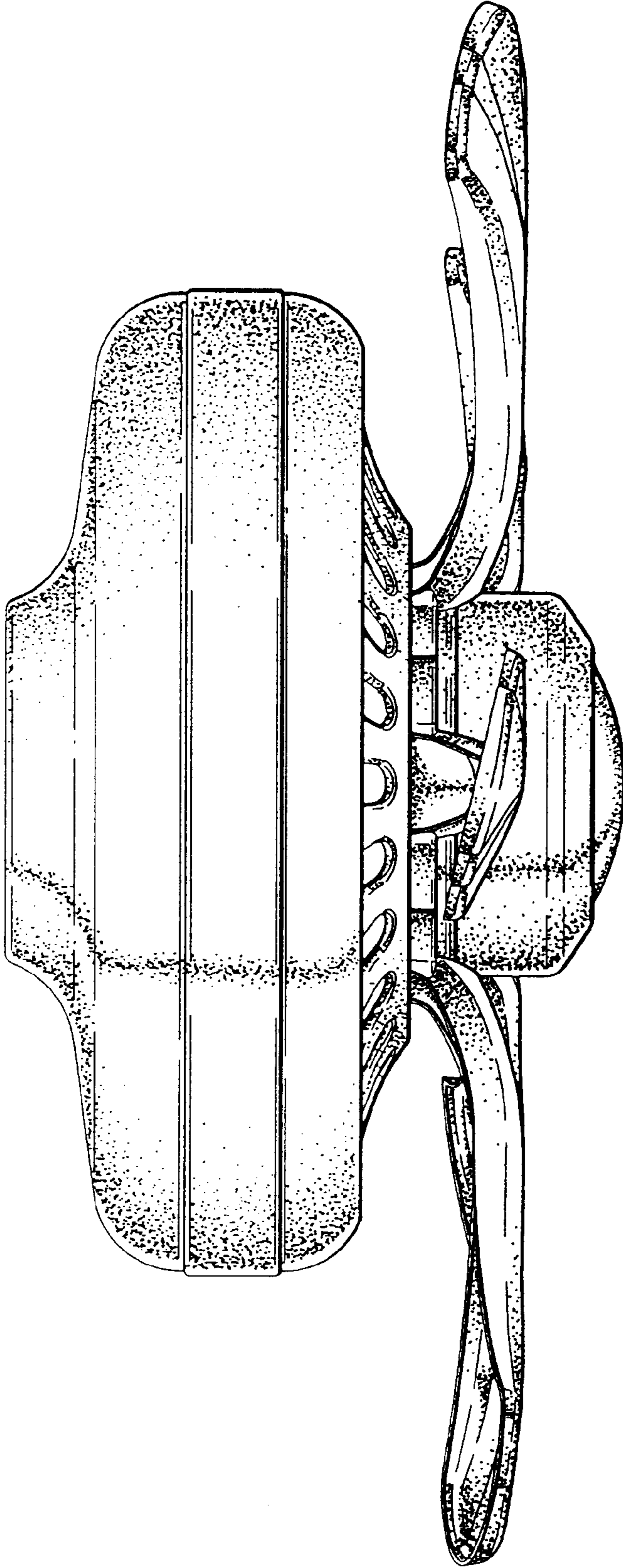

FIG 13

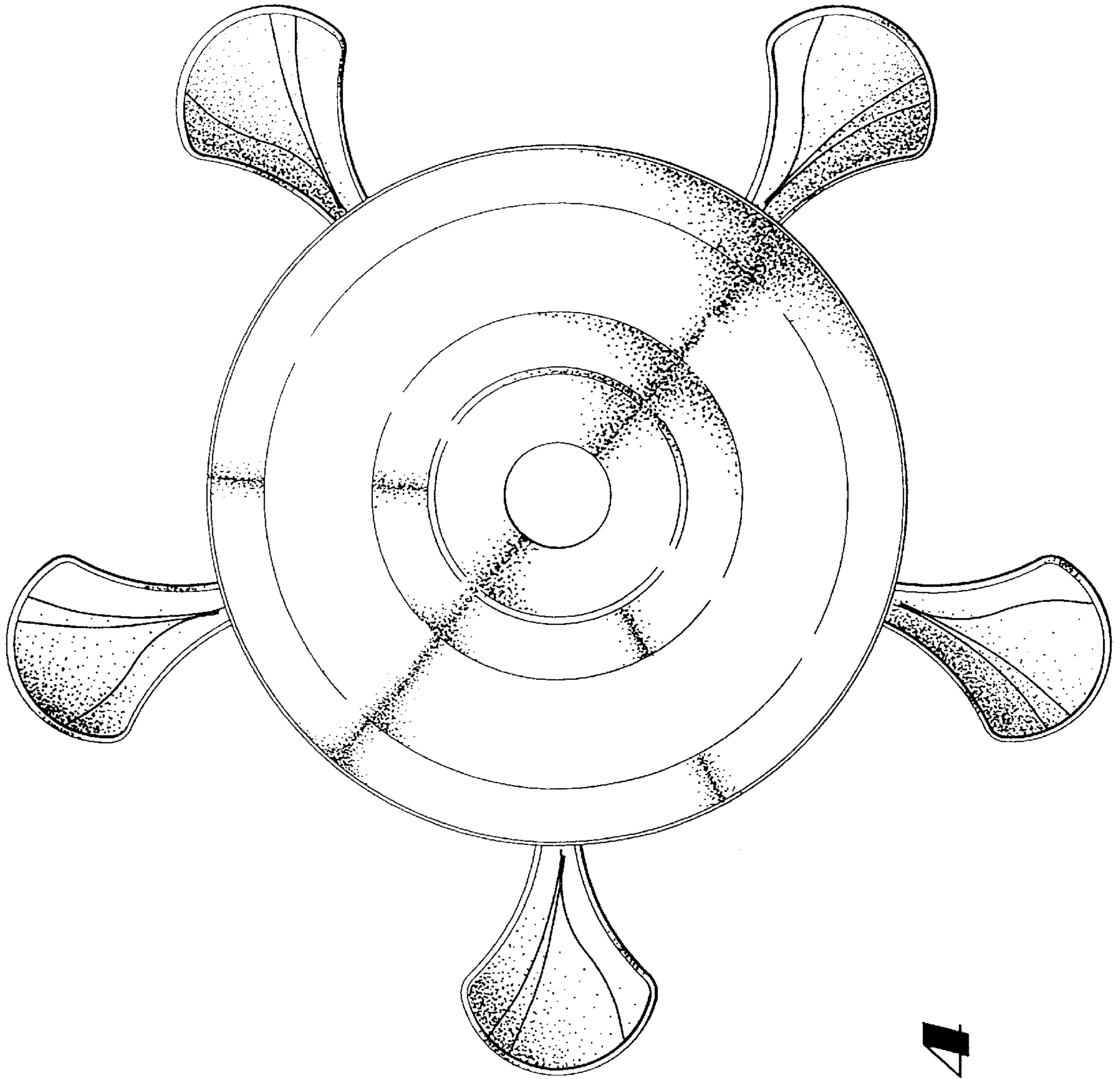

FIG 14