



US00D409279S

United States Patent [19]

Hayashi et al.

[11] Patent Number: **Des. 409,279**

[45] Date of Patent: **** May 4, 1999**

[54] **AIR SUPPLY AND DISCHARGE BLOCK FOR AN ELECTROMAGNETIC VALVE ASSEMBLY**

5,462,087 10/1995 Fukano et al. 137/884
5,664,604 9/1997 Sato et al. 137/884

[75] Inventors: **Bunya Hayashi; Takumi Matsumoto; Masaru Narita**, all of Yawara-mura, Japan

FOREIGN PATENT DOCUMENTS

189487 8/1991 Japan 137/884

[73] Assignee: **SMC Corporation**, Tokyo, Japan

Primary Examiner—Ted Shooman
Assistant Examiner—C. Tuttle
Attorney, Agent, or Firm—Oblon, Spivak, McClelland, Maier & Neustadt, P.C.

[**] Term: **14 Years**

[57] CLAIM

[21] Appl. No.: **29/064,831**

The ornamental design for air supply and discharge block for an electromagnetic valve assembly, as shown and described.

[22] Filed: **Jan. 10, 1997**

DESCRIPTION

[30] Foreign Application Priority Data

Jul. 10, 1996 [JP] Japan 8-20562

FIG. 1 is a front elevational view of air supply and discharge block for an electromagnetic valve assembly embodying our new design;

[51] **LOC (6) Cl.** **23-01**

FIG. 2 is a rear elevational view thereof;

[52] **U.S. Cl.** **D23/233**

FIG. 3 is a top plan view thereof;

[58] **Field of Search** D23/233, 248, D23/249; 137/884, 625.64, 271, 269

FIG. 4 is a bottom plan view thereof;

FIG. 5 is a right side elevational view thereof;

[56] References Cited

U.S. PATENT DOCUMENTS

D. 271,587 11/1983 Ise D15/7
D. 295,050 4/1988 Kanno D15/7
4,815,496 3/1989 Nishitani et al. 137/884
5,333,647 8/1994 Fukano et al. 137/884
5,459,953 10/1995 Fukano et al. 137/625.64

FIG. 6 is a left side elevational view thereof;

FIG. 7 is a top, front and left side perspective view thereof; and,

FIG. 8 is a bottom, rear and right side perspective view thereof.

1 Claim, 4 Drawing Sheets

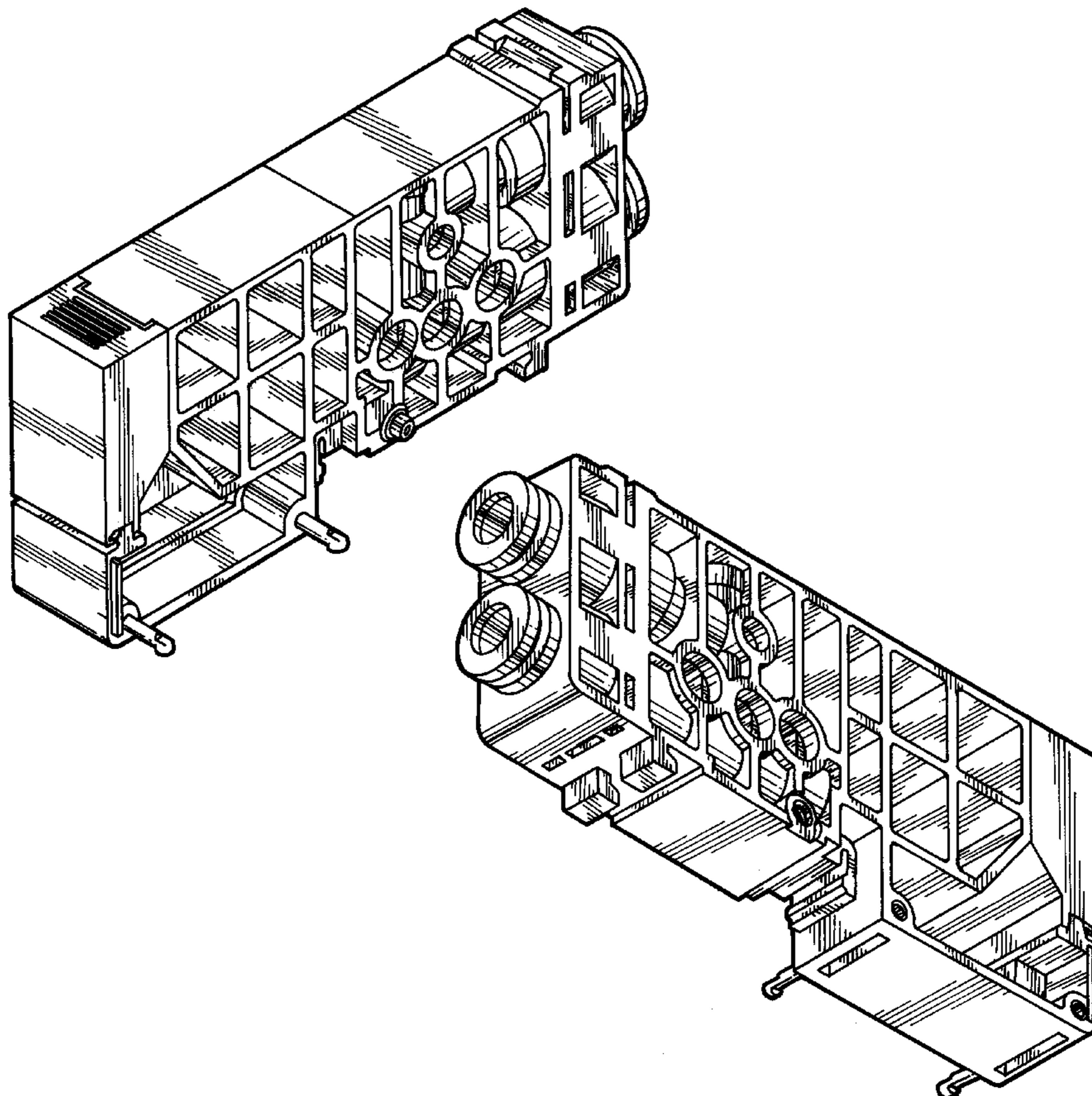

FIG. 1

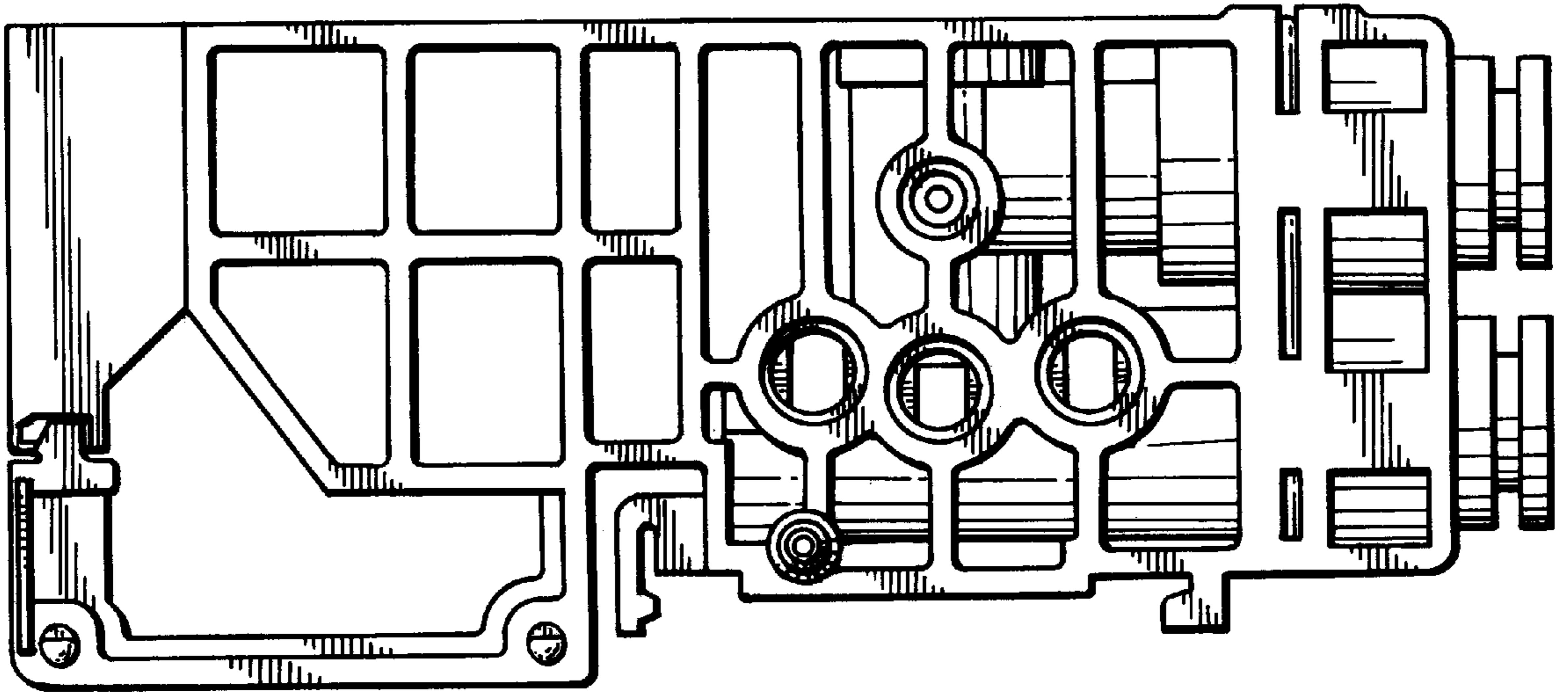

FIG. 2

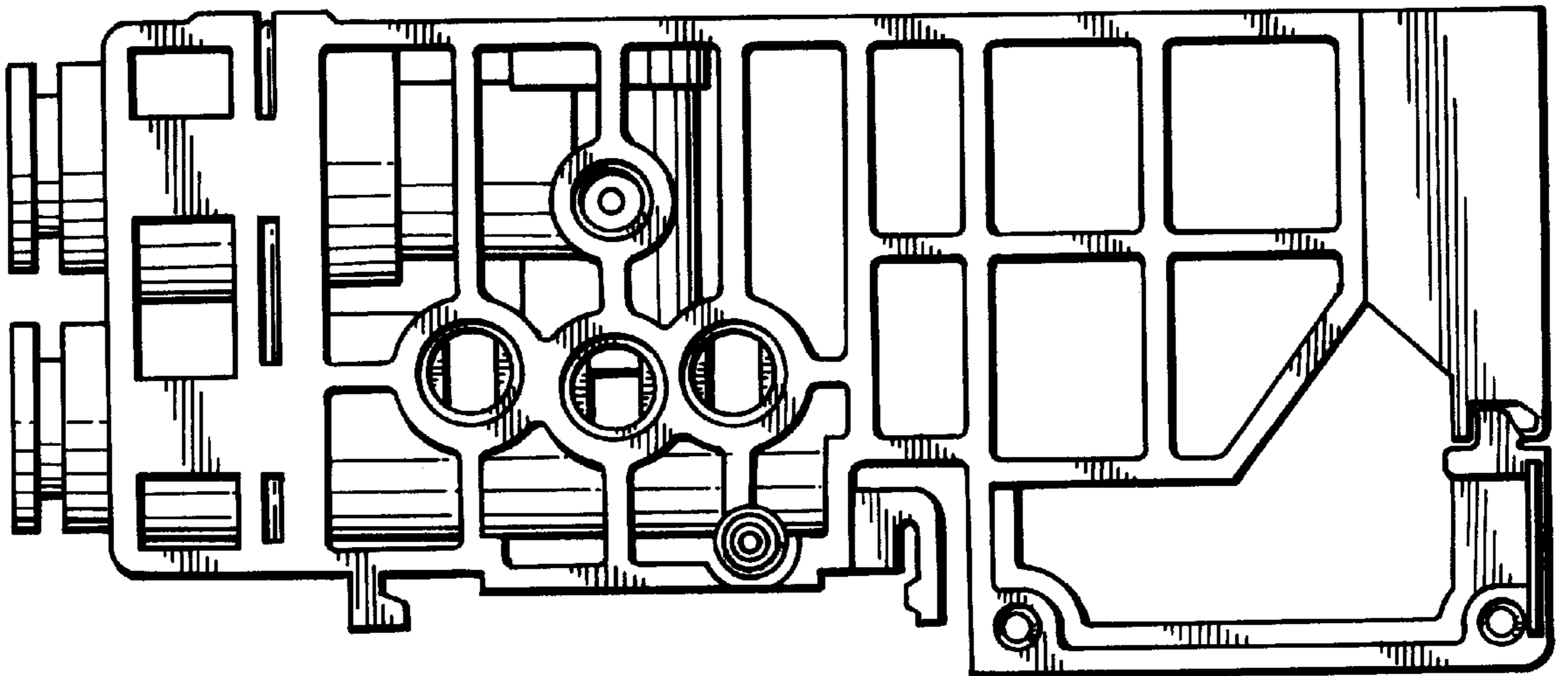

FIG. 3

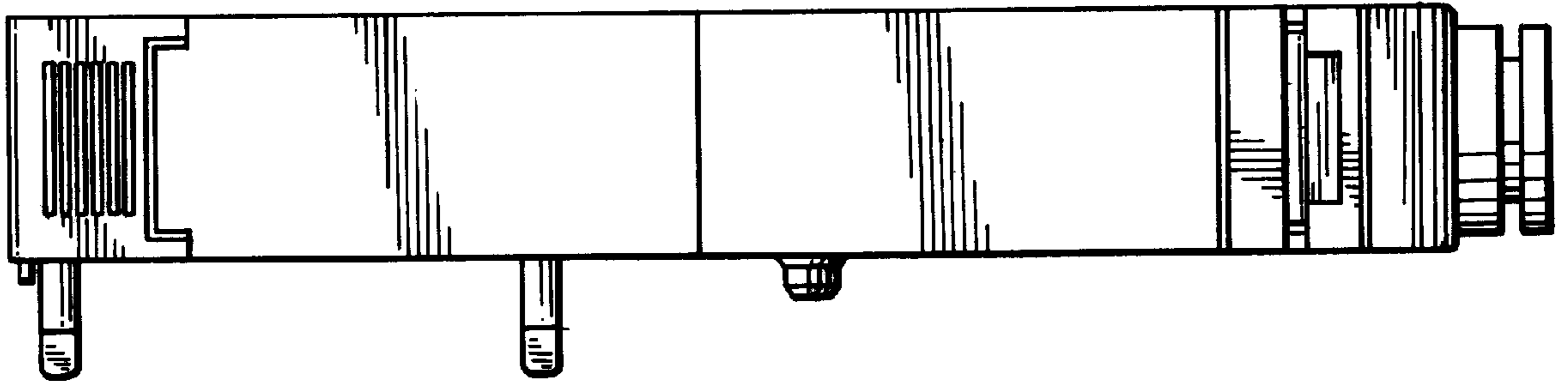

FIG. 4

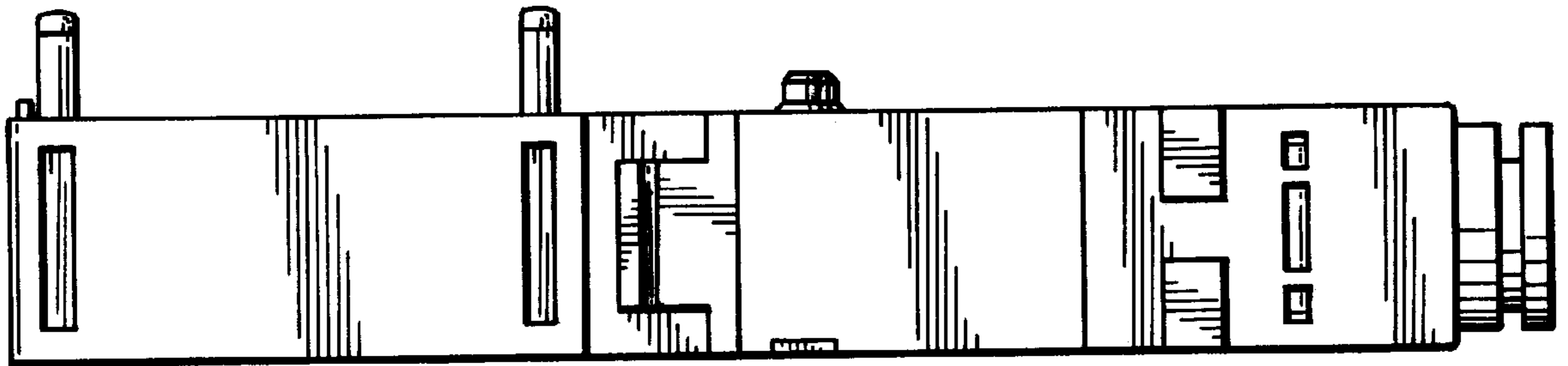

FIG. 5

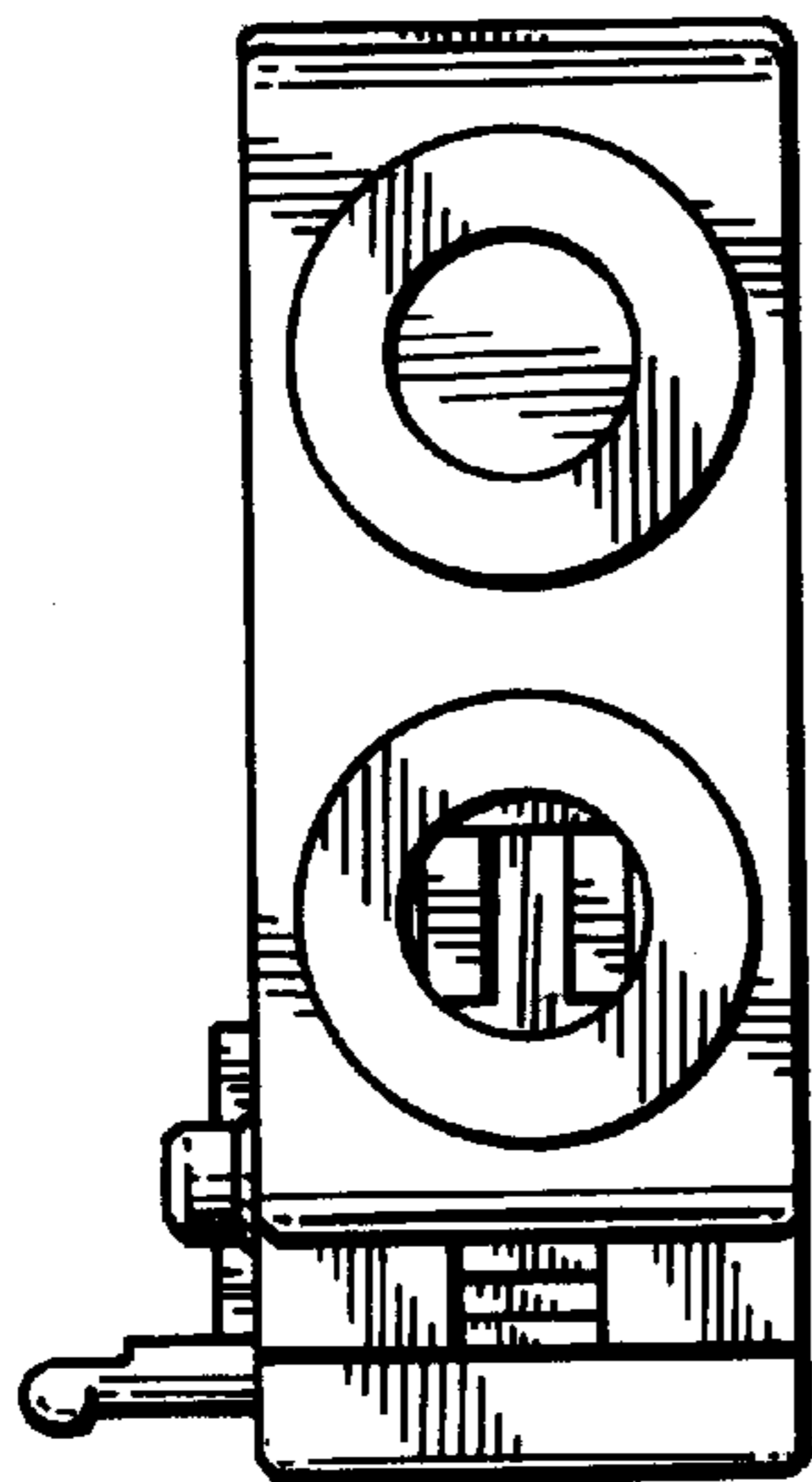
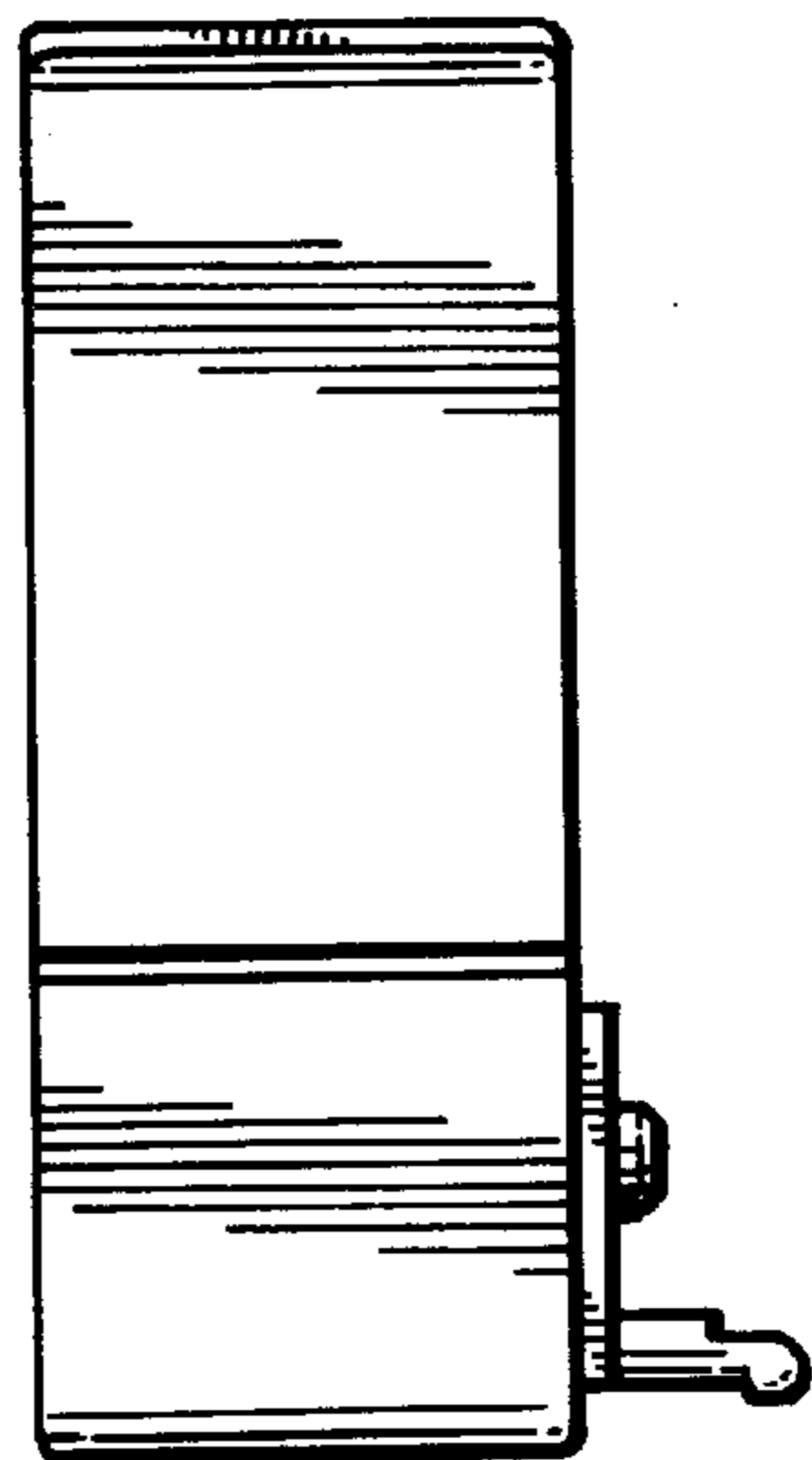

FIG. 6



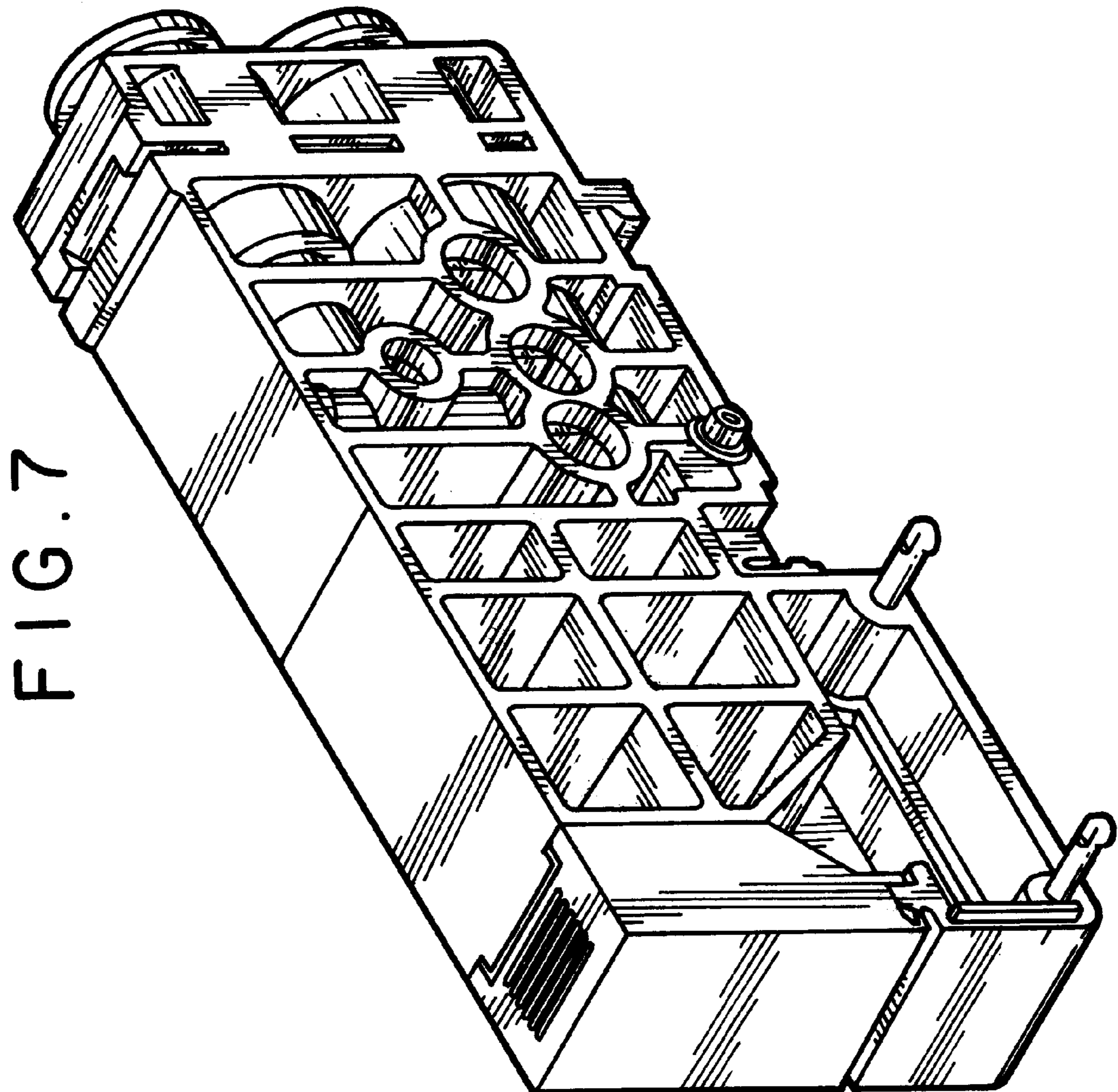

FIG. 8

