



US00D409190S

# United States Patent [19]

[11] Patent Number: **Des. 409,190**

Tamura et al.

[45] Date of Patent: **\*\* May 4, 1999**

[54] **WIRELESS TELEPHONE**

[75] Inventors: **Masao Tamura; Katsumi Nagano; Hiroki Nishii; Toshiro Iizuka**, all of Kanagawa, Japan

[73] Assignee: **Matsushita Electric Industrial Co., Ltd.**

[\*\*] Term: **14 Years**

[21] Appl. No.: **29/075,280**

[22] Filed: **Aug. 18, 1997**

### [30] Foreign Application Priority Data

Feb. 28, 1997 [JP] Japan ..... 9-5992

[51] **LOC (6) Cl.** ..... **14-03**

[52] **U.S. Cl.** ..... **D14/151**

[58] **Field of Search** ..... D14/137, 138, D14/148, 147, 149-151, 140-142, 240, 241; 379/433-436, 419, 420, 428, 440; D13/107, 108

### [56] References Cited

#### U.S. PATENT DOCUMENTS

- D. 306,861 3/1990 Oshima et al. .... D14/151
- D. 311,399 10/1990 Ando ..... D14/241
- D. 314,766 2/1991 Goatman ..... D14/151

- D. 319,829 9/1991 Wu ..... D14/151
- D. 334,932 4/1993 Yu ..... D14/151
- D. 346,785 5/1994 Lundell et al. .... D13/108
- D. 349,899 8/1994 Siddoway et al. .... D14/151
- D. 352,032 11/1994 Cowan ..... D14/151
- D. 356,087 3/1995 Jarrett et al. .... D14/151
- D. 359,284 6/1995 Hung ..... D14/151
- D. 370,482 6/1996 Kong et al. .... D14/151
- D. 372,027 7/1996 Tomoike ..... D14/148 X
- D. 375,935 11/1996 Nagele et al. .... D13/108
- D. 384,663 10/1997 Solomita et al. .... D14/141
- 5,778,062 7/1998 Vanmoor ..... 379/428

*Primary Examiner*—Jeffrey Asch  
*Attorney, Agent, or Firm*—Saidman DesignLaw Group

### [57] CLAIM

The ornamental design for a wireless telephone, as shown and described.

### DESCRIPTION

FIG. 1 is a perspective view of the front, bottom and right side of a wireless telephone showing our new design; FIG. 2 is a bottom view thereof; FIG. 3 is a front view thereof; FIG. 4 is a top plan view thereof; FIG. 5 is a right side view thereof; FIG. 6 is a left side view thereof; and, FIG. 7 is a rear view thereof.

**1 Claim, 4 Drawing Sheets**

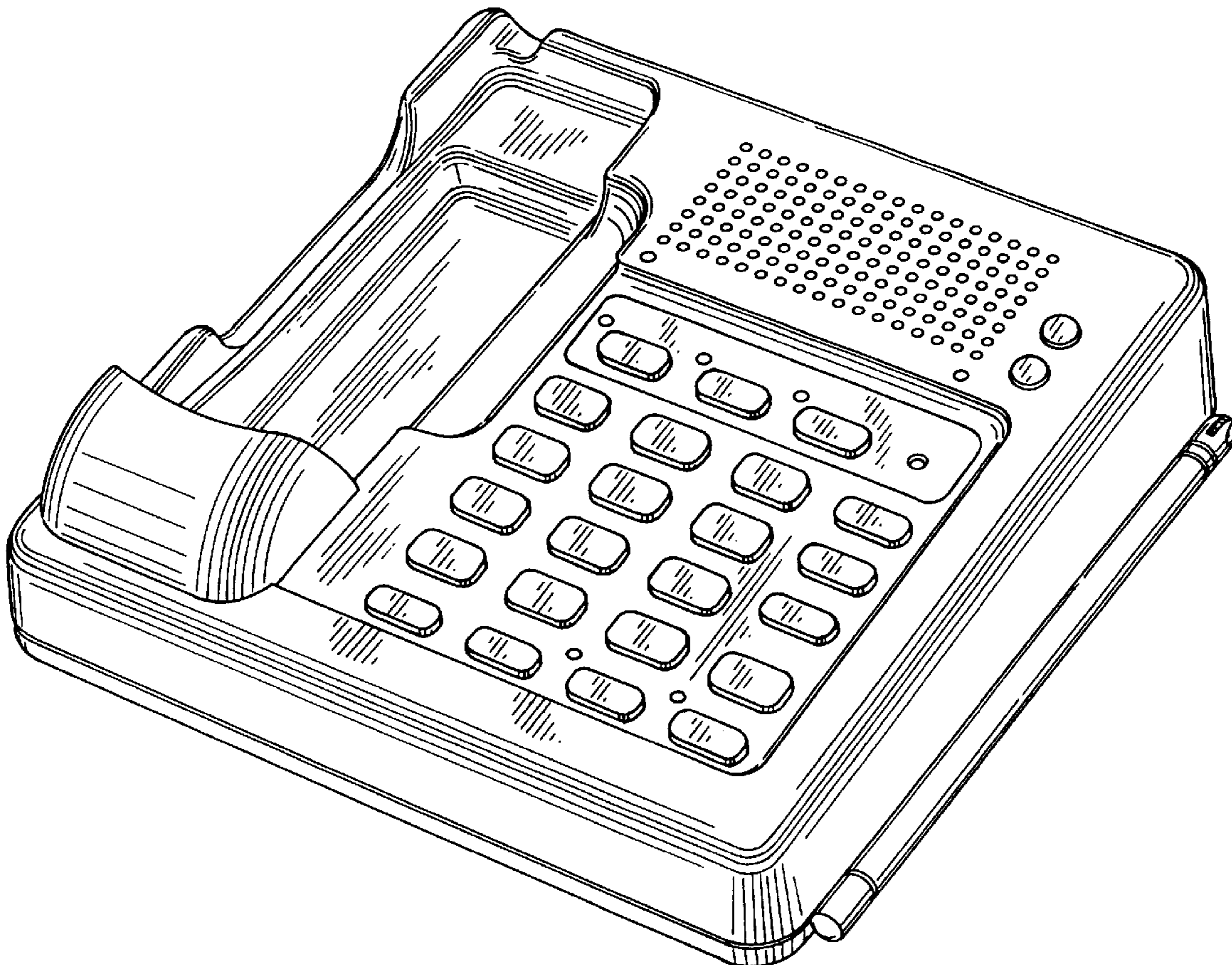

FIG. 1

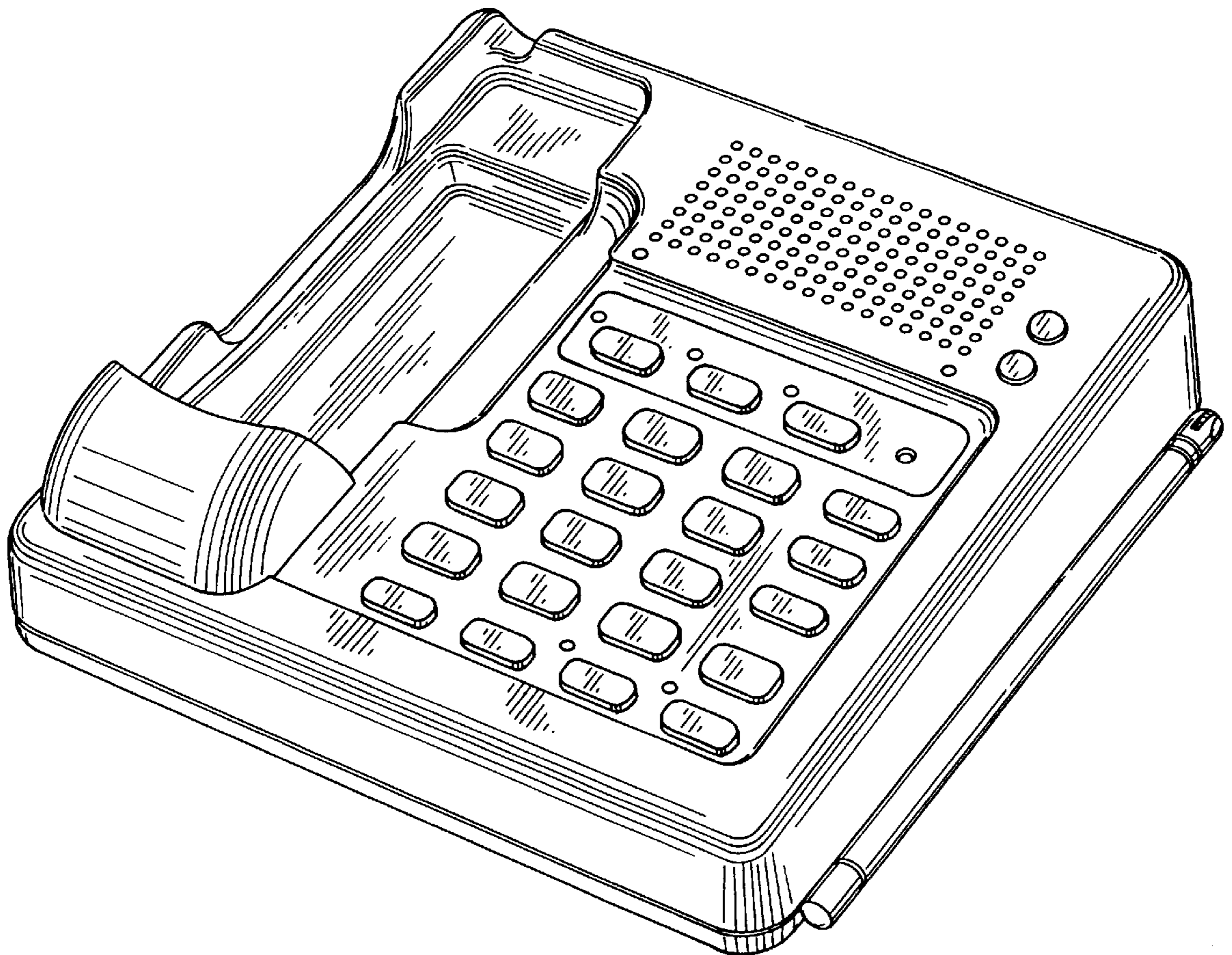

FIG. 2

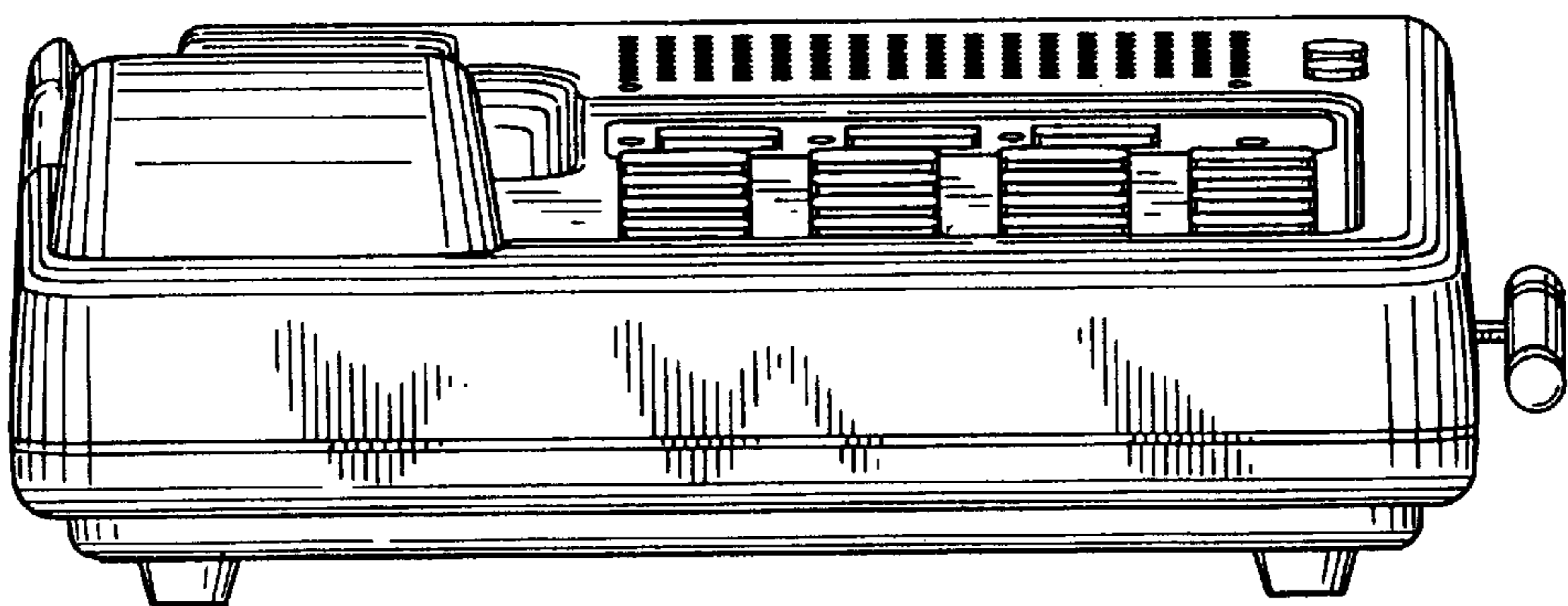

FIG. 3

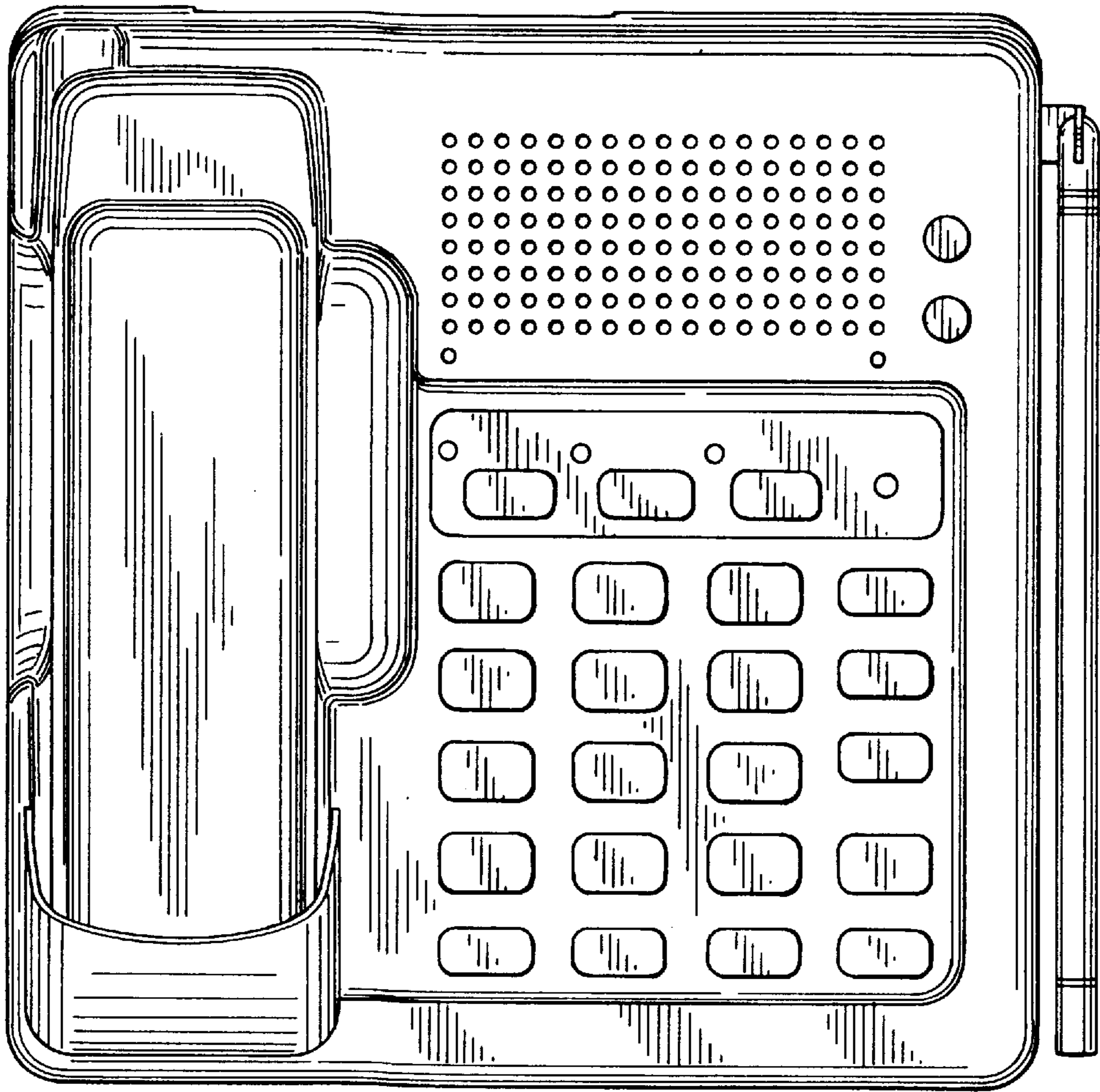
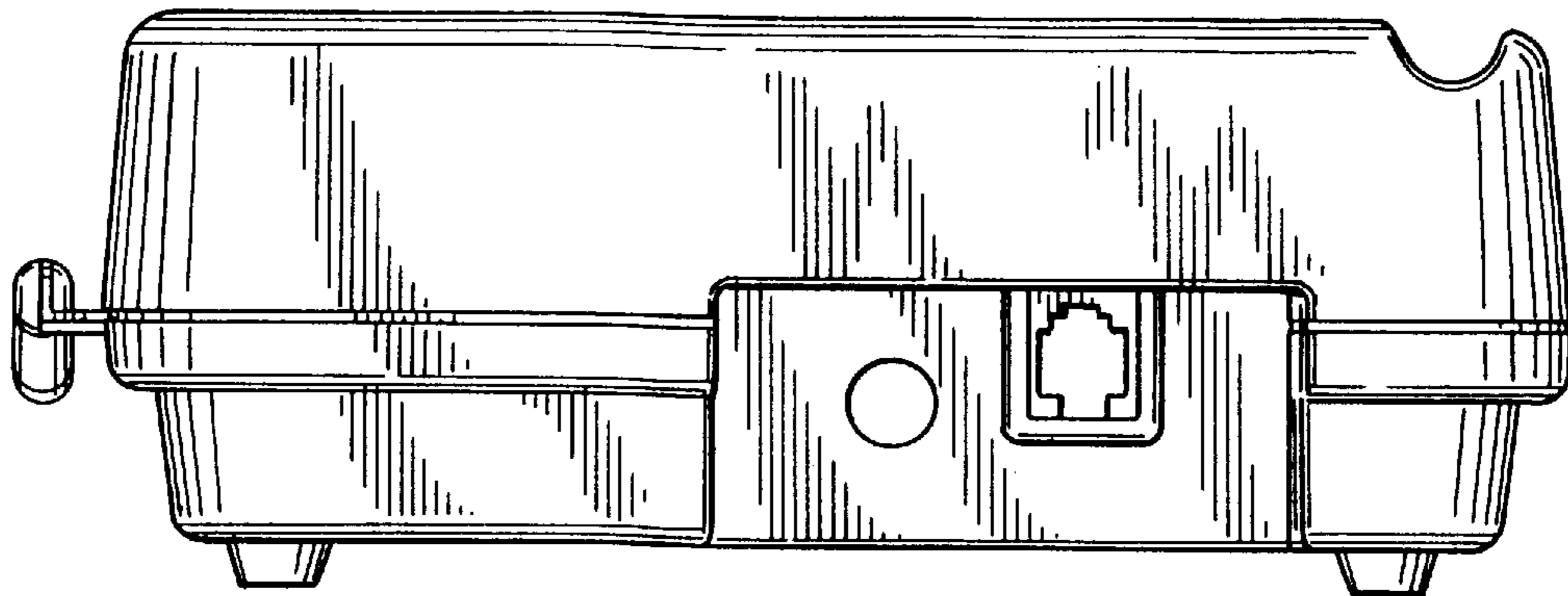
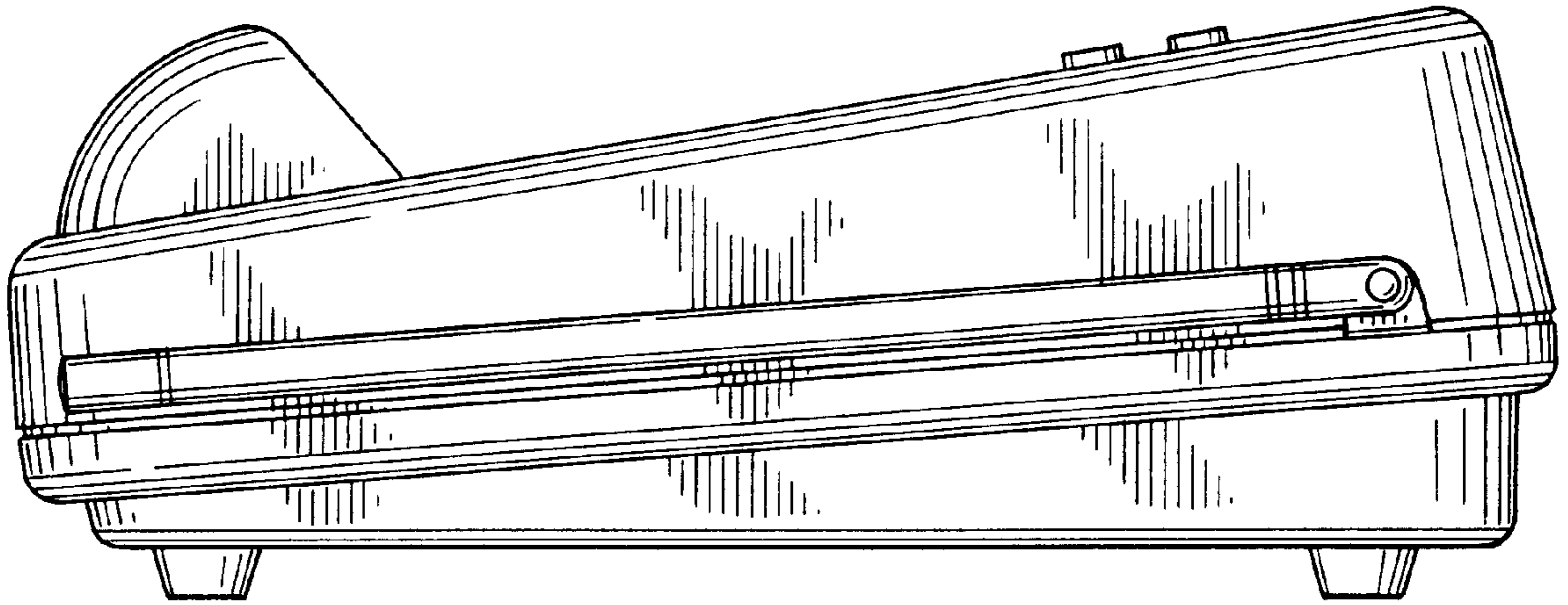

FIG. 4



*FIG. 5*



*FIG. 6*

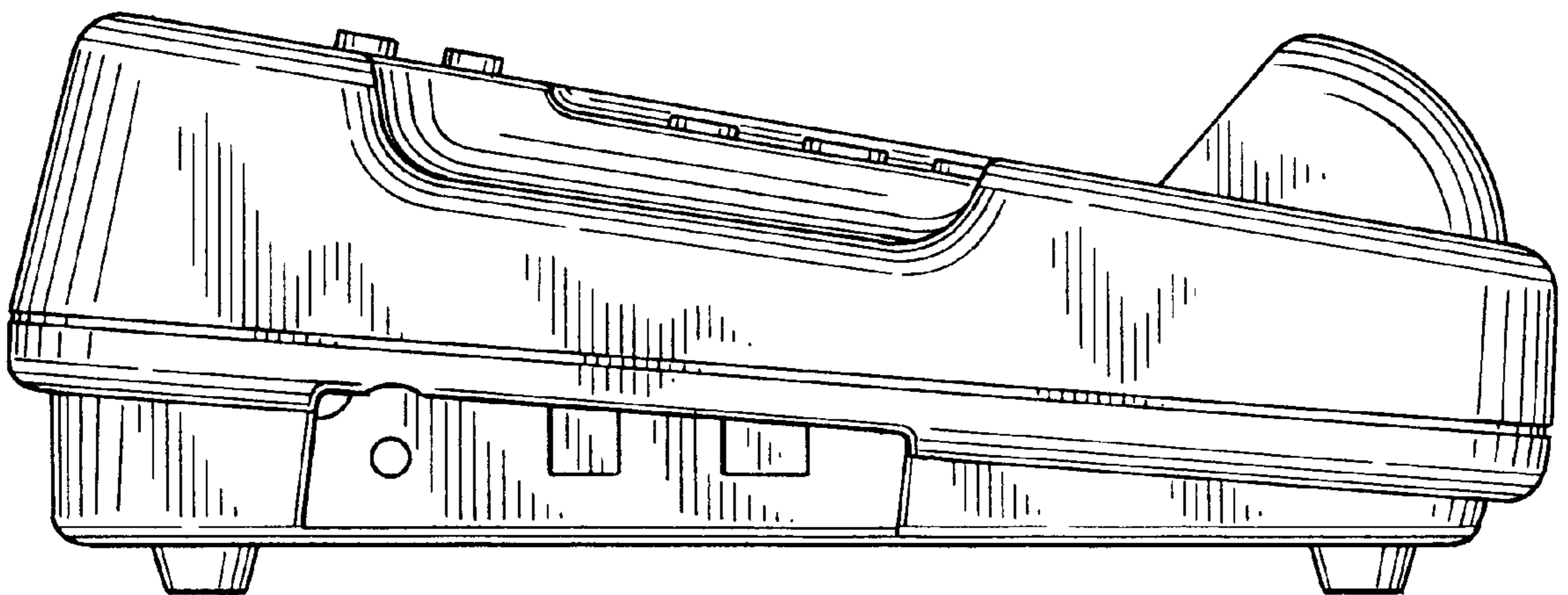

FIG. 7

