



US00D409171S

United States Patent [19] Wu

[11] Patent Number: **Des. 409,171**

[45] Date of Patent: **** May 4, 1999**

[54] **COMPUTER RACK HOUSING**

[75] Inventor: **Jeff Wu**, Mission Viejo, Calif.

[73] Assignee: **Commercial & Industrial Design Co., Inc.**, Costa Mesa, Calif.

[**] Term: **14 Years**

[21] Appl. No.: **29/085,285**

[22] Filed: **Mar. 19, 1998**

[51] **LOC (6) Cl.** **14-02**

[52] **U.S. Cl.** **D14/114**

[58] **Field of Search** D14/100, 105,
D14/107, 109, 114; D13/184, 162, 199;
361/680-5, 728-36; 360/99.01, 99.12; 312/208.1

[56] **References Cited**

U.S. PATENT DOCUMENTS

D. 304,323	10/1989	Cranston, III et al.	D14/10 X
D. 305,229	12/1989	Milani	D14/114
D. 334,176	3/1993	Steinbugler	D14/100
D. 336,289	6/1993	Hill	D14/109
D. 342,238	12/1993	Tedham et al.	D14/100
D. 372,021	7/1996	Idleman et al.	D14/109
D. 377,482	1/1997	Geck	D14/109
D. 386,478	11/1997	Alfonso et al.	D14/100
4,717,982	1/1988	Toreson et al. .	
4,754,397	6/1988	Varaiya et al. .	
4,941,841	7/1990	Darden et al. .	
4,964,017	10/1990	Jindrick et al. .	
5,211,459	5/1993	Wu .	

FOREIGN PATENT DOCUMENTS

1274311 5/1972 United Kingdom .

Primary Examiner—M. H. Tung
Attorney, Agent, or Firm—Knobbe, Martens, Olson & Bear LLP

[57] **CLAIM**

The ornamental design for a computer rack housing, as shown and described.

DESCRIPTION

FIG. 1 is a perspective view of a computer rack housing having features in accordance with the present invention, the housing body and access panels being shown in phantom for illustrative purposes only and forms no part of the claimed design;

FIG. 2 is a front elevational view of the computer rack housing of FIG. 1;

FIG. 3 is a top plan view of the computer rack housing of FIG. 1;

FIG. 4 is a bottom plan view of the computer rack housing of FIG. 1, the housing body and access panel being shown in phantom for illustrative purposes only and forms no part of the claimed design;

FIG. 5 is a left side elevational view of the computer rack housing of FIG. 1; and,

FIG. 6 is a right side elevational view of the computer rack housing of FIG. 1.

The broken line disclosure in FIGS. 3, 5 and 6 is for illustrative purposes only and forms no part of the claimed design.

1 Claim, 4 Drawing Sheets

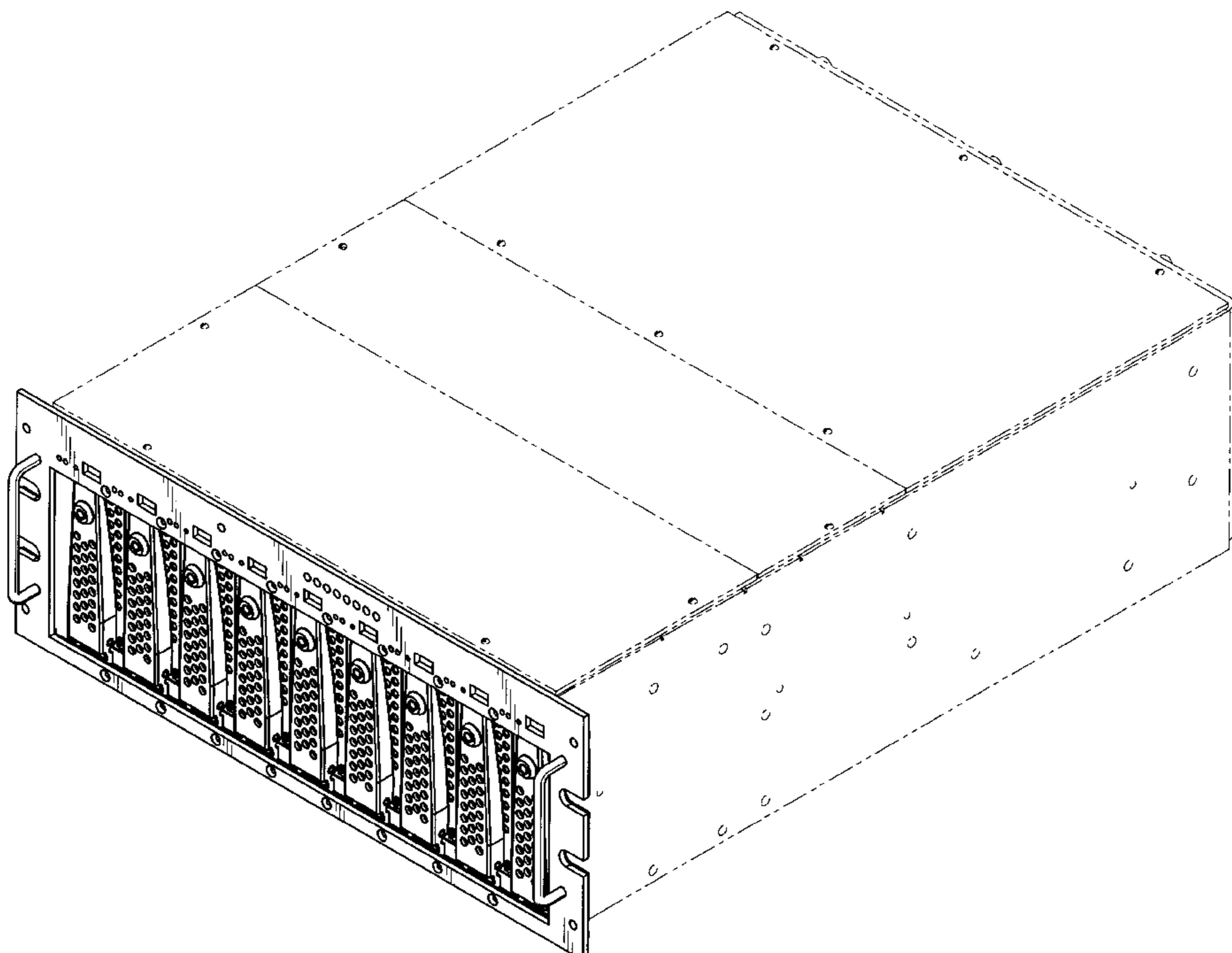

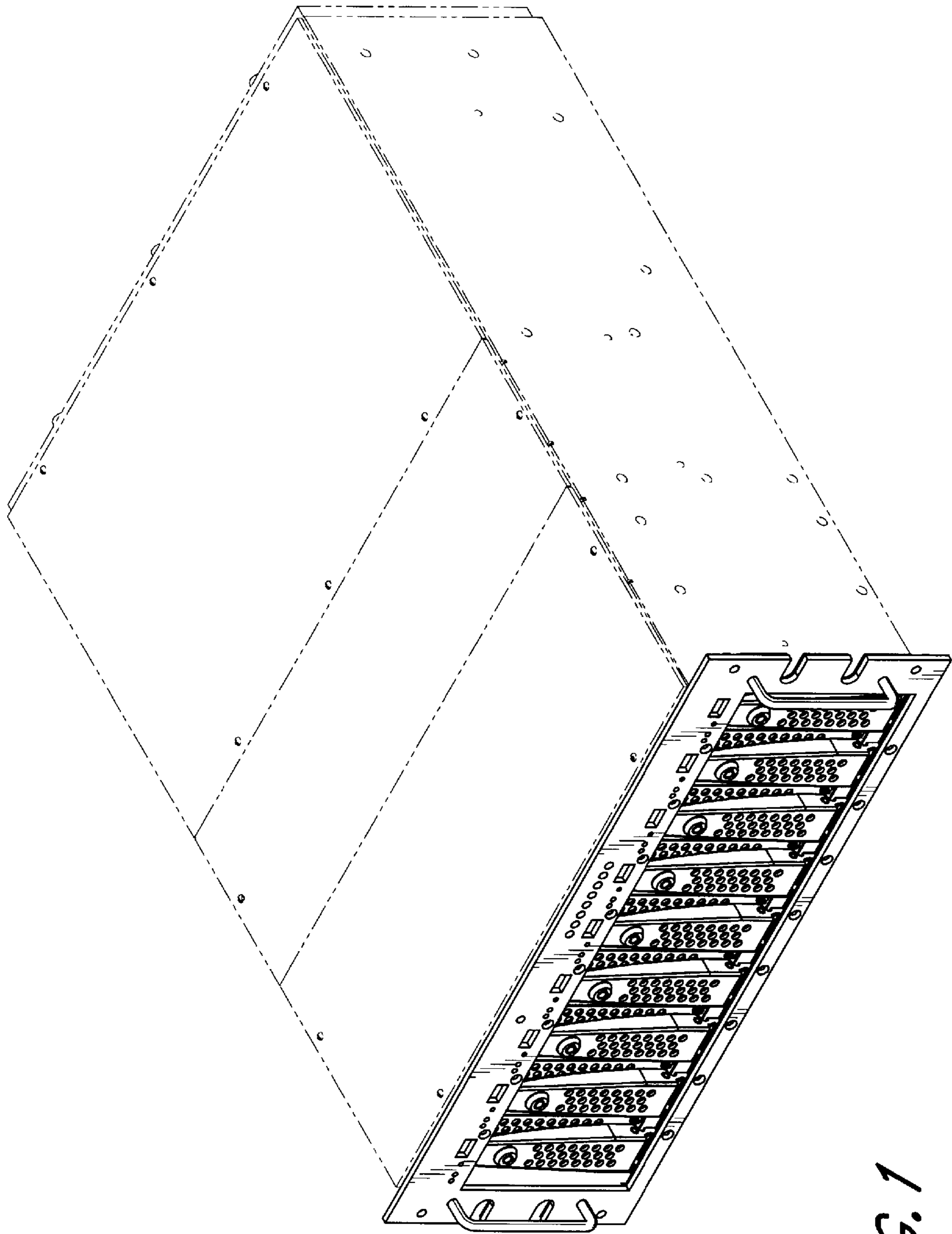

FIG. 1

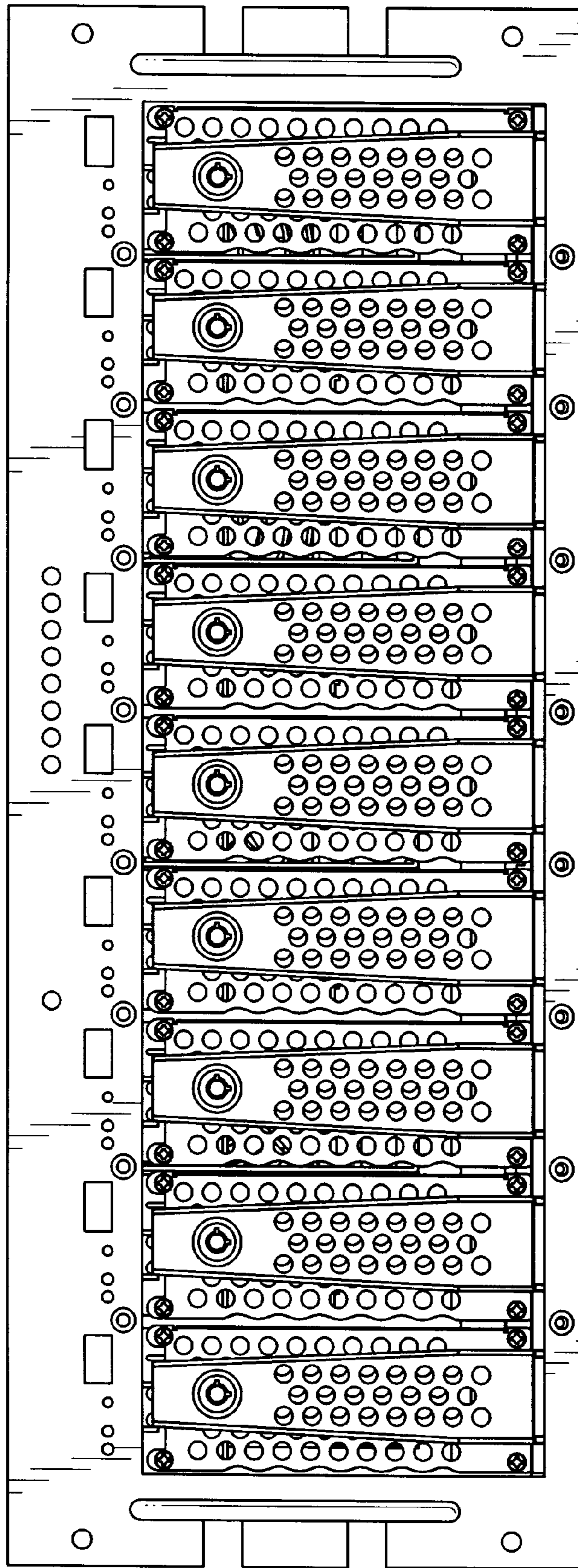

FIG. 2

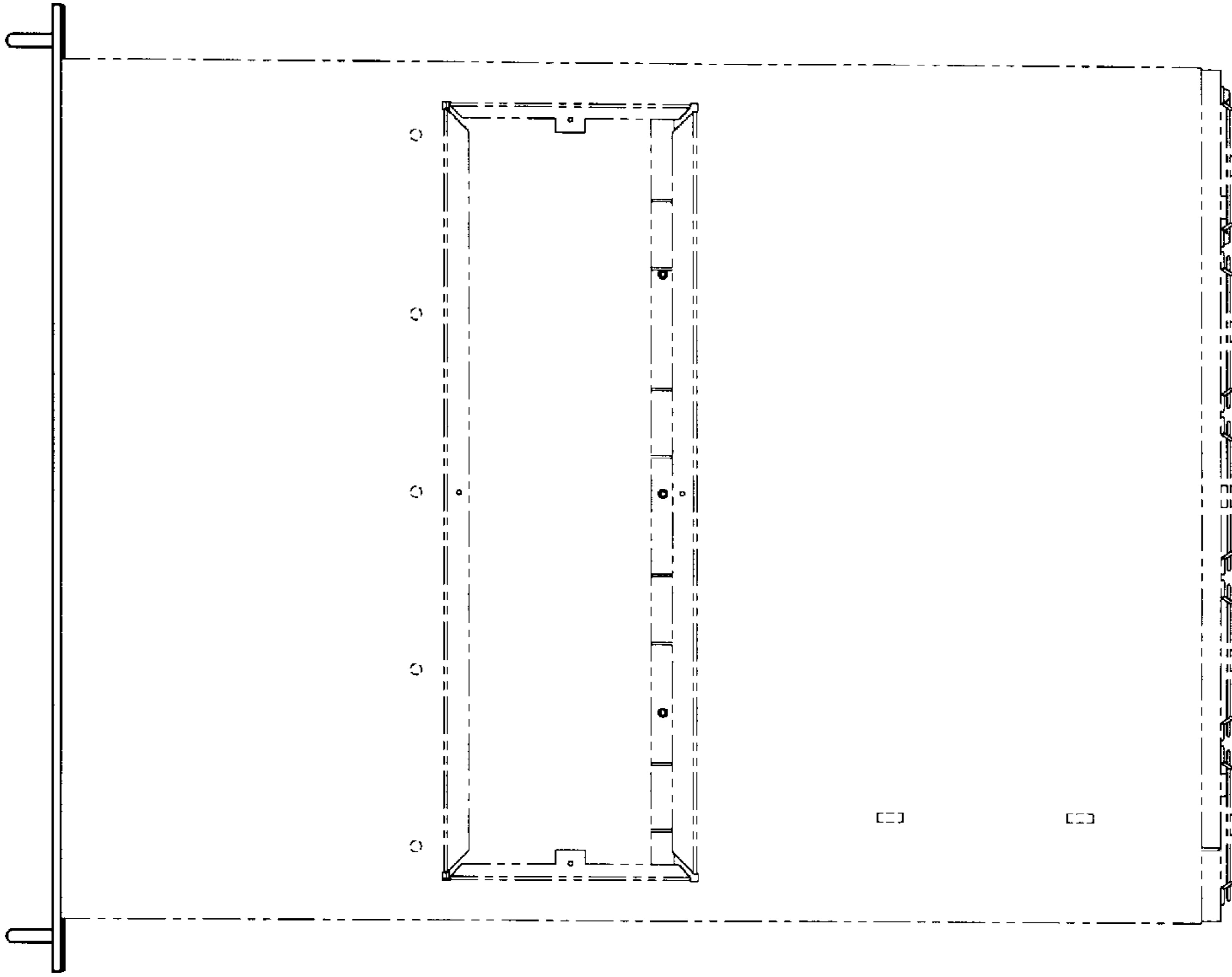

FIG. 4

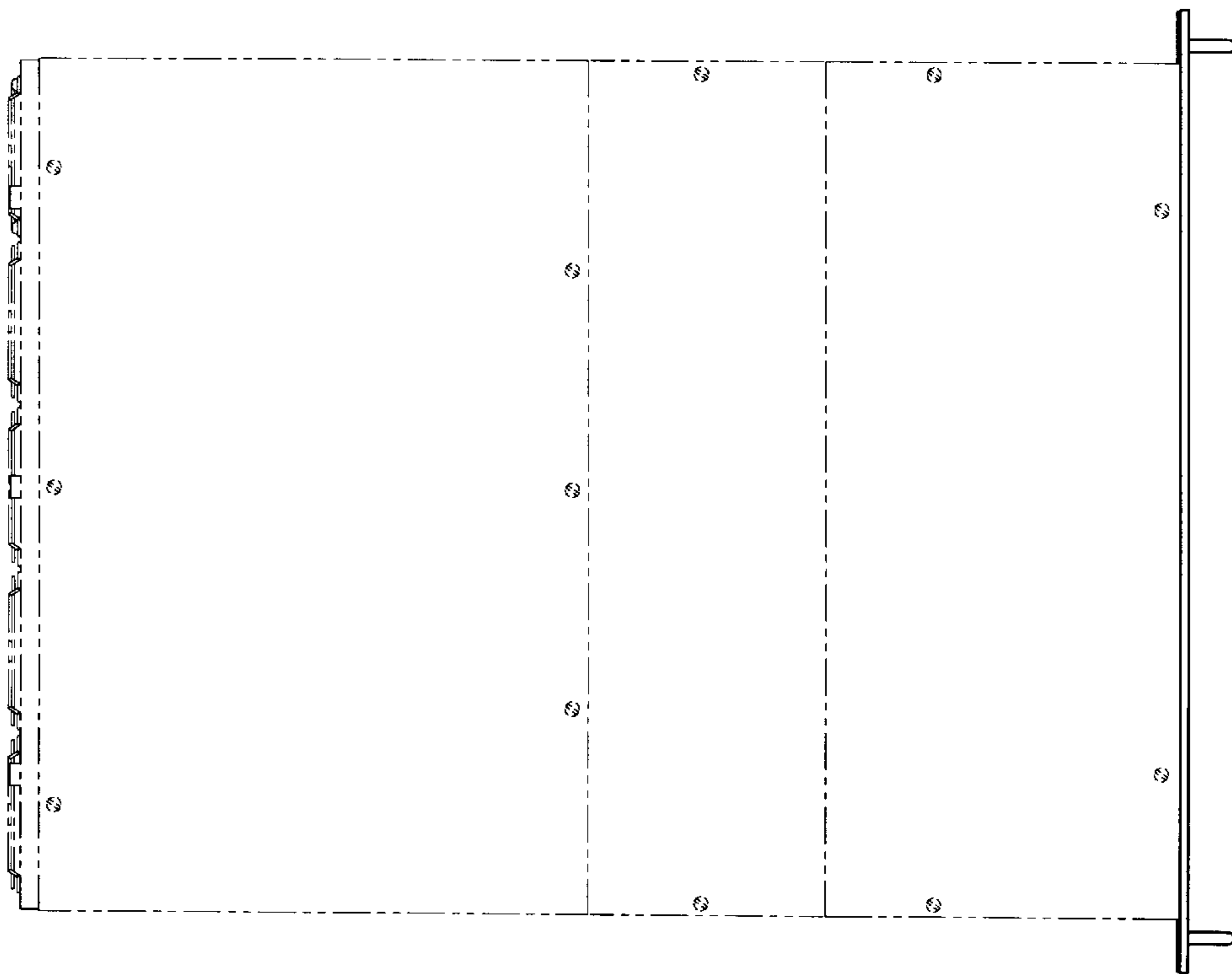

FIG. 3

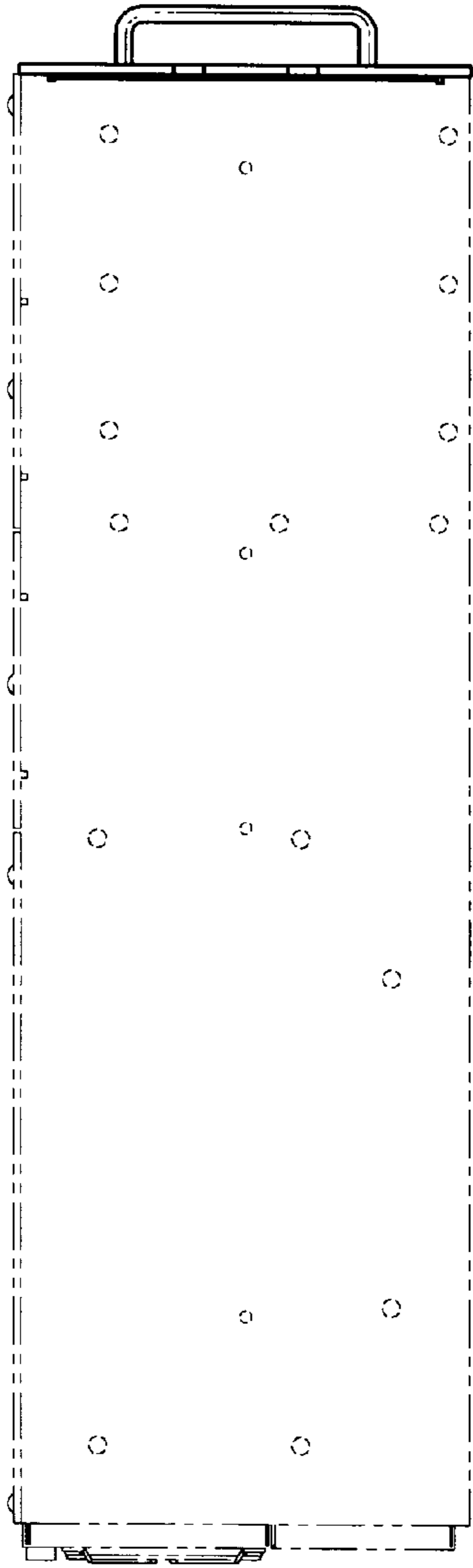

FIG. 5

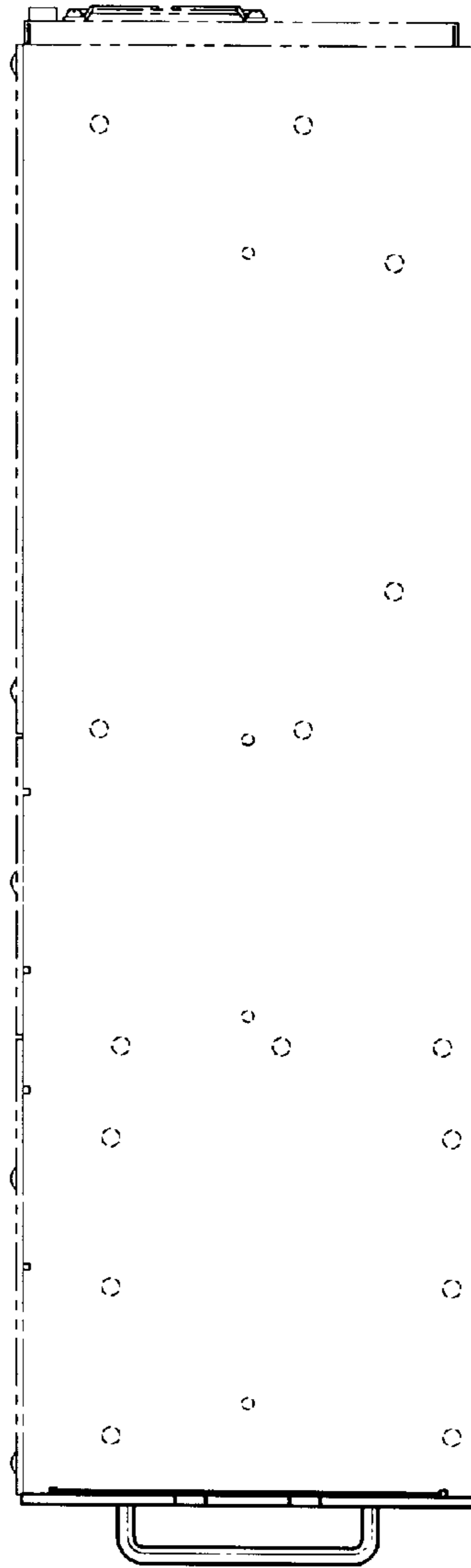

FIG. 6