



US00D409090S

United States Patent [19]

Lai et al.

[11] Patent Number: **Des. 409,090**

[45] Date of Patent: **** May 4, 1999**

[54] CONTAINER

[75] Inventors: **John W. Lai**, San Francisco, Calif.;
Peter C. Simpson, Glencoe; **Thomas J. Melk**, Chicago, both of Ill.

[73] Assignee: **Outer Circle Products, Ltd.**, Chicago, Ill.

[**] Term: **14 Years**

[21] Appl. No.: **29/071,263**

[22] Filed: **May 21, 1997**

Related U.S. Application Data

[63] Continuation of application No. 29/061,888, Nov. 1, 1996, abandoned.

[51] LOC (6) Cl. **09-01**

[52] U.S. Cl. **D9/523; D9/528; D9/543**

[58] Field of Search D9/523, 528, 543,
D9/337, 341; 215/382, 383, 384, 6, 396,
398

[56] References Cited

U.S. PATENT DOCUMENTS

D. 173,430 11/1954 Hills D9/523
D. 195,064 4/1963 Dike D9/523

D. 210,114 2/1968 Gantz D9/523
D. 332,224 1/1993 Lynd et al. D9/523
D. 346,555 5/1994 Binder D9/523

Primary Examiner—Lucy Lieberman
Attorney, Agent, or Firm—Trexler, Bushnell, Giangiorgi & Blackstone, Ltd.

[57] CLAIM

The ornamental design for a container, as shown and described.

DESCRIPTION

FIG. 1 is a perspective view of a container showing the design with a threaded neck shown in broken line, this broken line element is provided for illustrative purposes only and forms no part of the claimed design; FIG. 2 is a front elevational view thereof, a rear elevational view is not provided as it is a mirror image of the front elevational view; FIG. 3 is a right side elevational view thereof; FIG. 4 is a left side elevational view thereof; FIG. 5 is a top plan view thereof; FIG. 6 is a bottom plan view thereof; and, FIG. 7 is a top, front and left side perspective view of a second embodiment of the container. The second embodiment differs from the first embodiment only in the changes in proportions that are shown in FIG. 7.

1 Claim, 4 Drawing Sheets

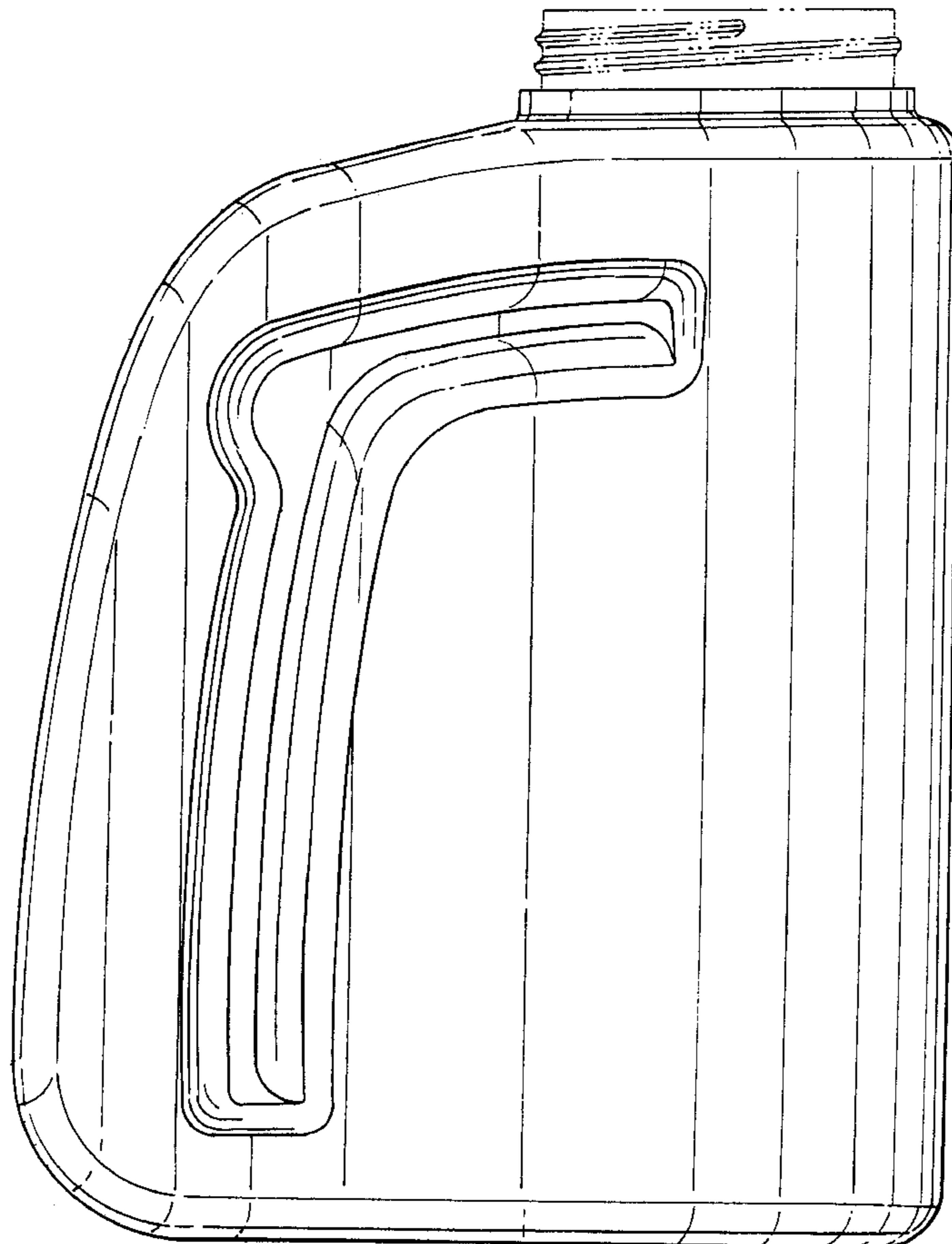

FIG. 1

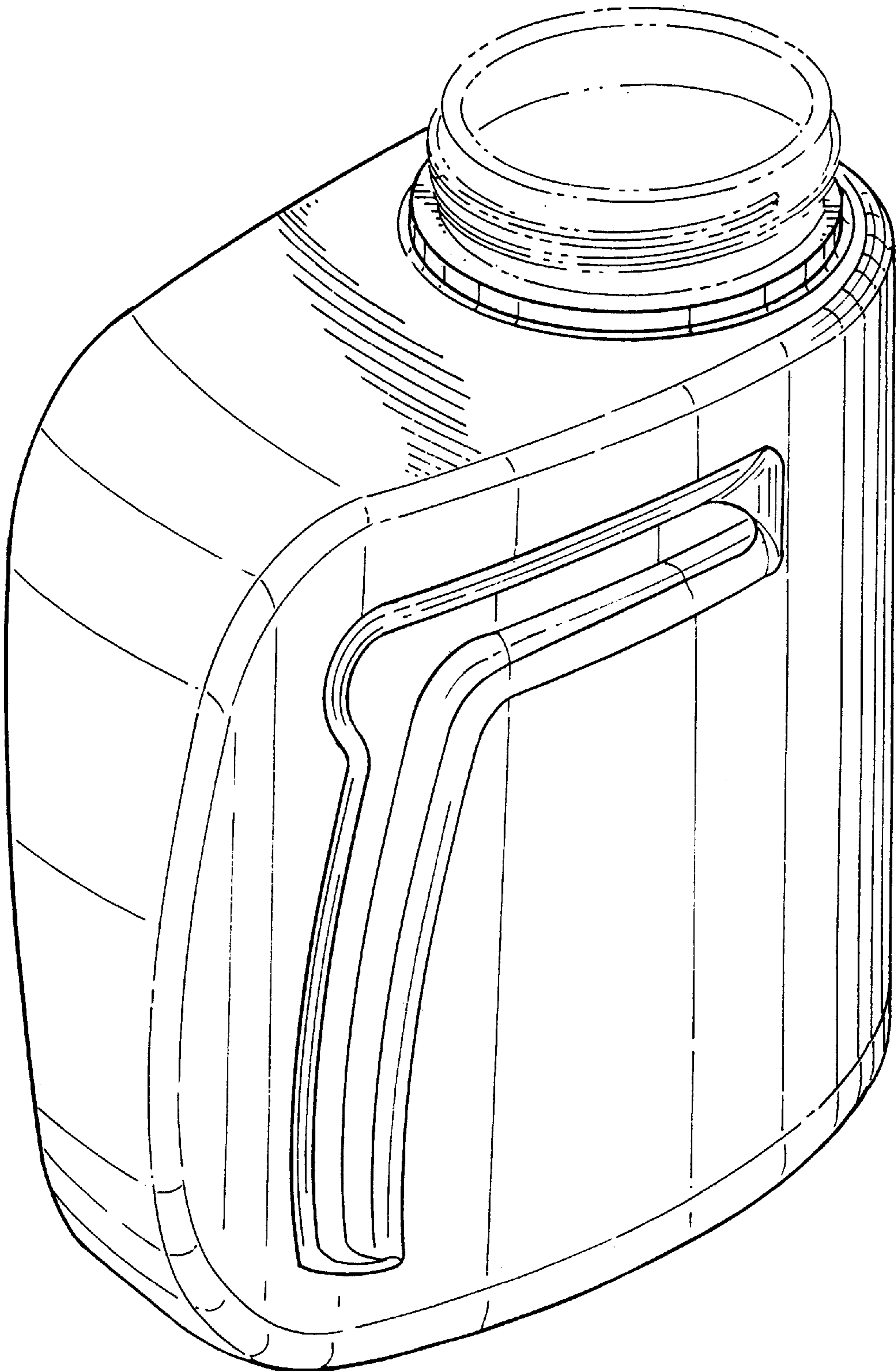

FIG. 2

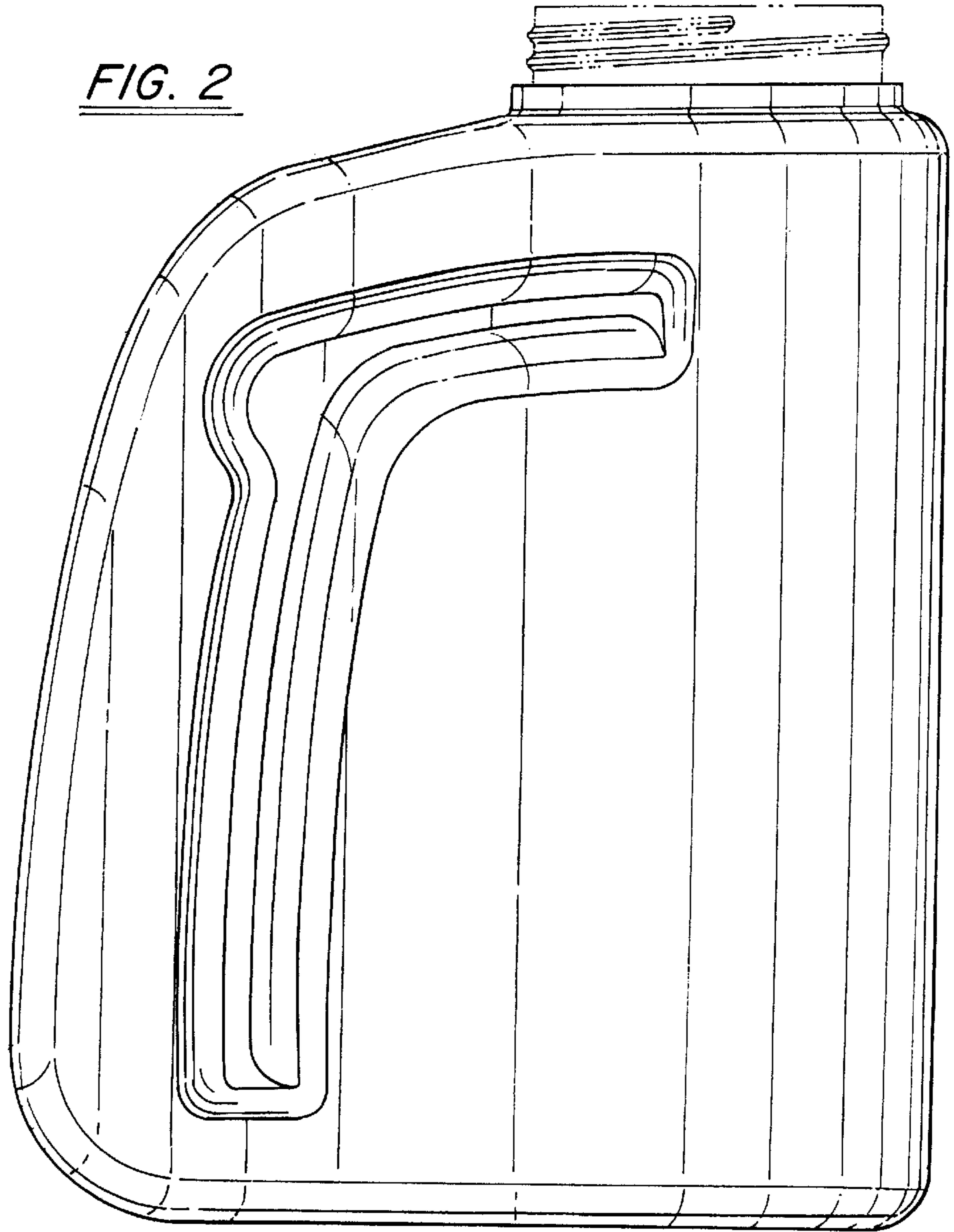
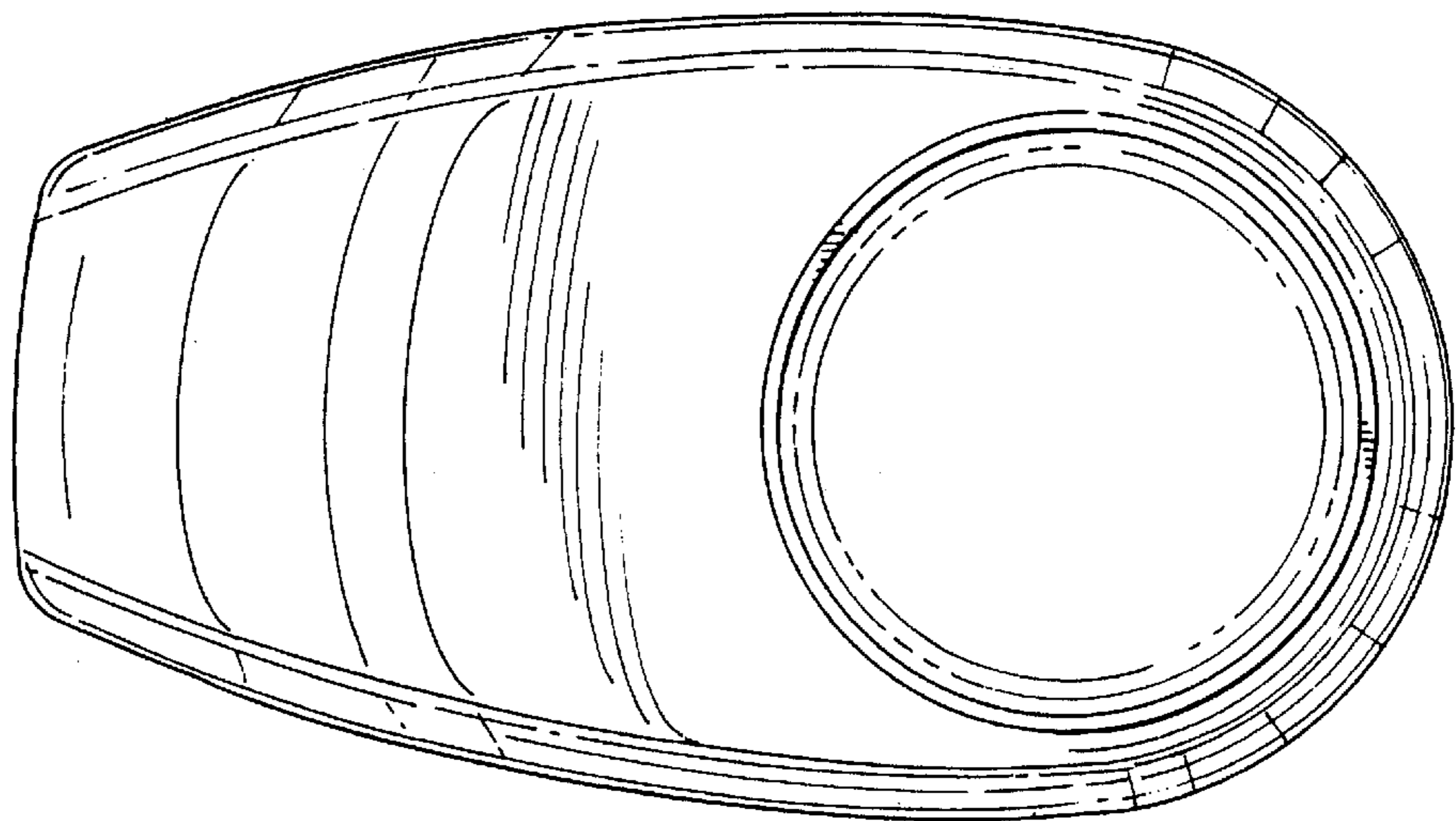

FIG. 5



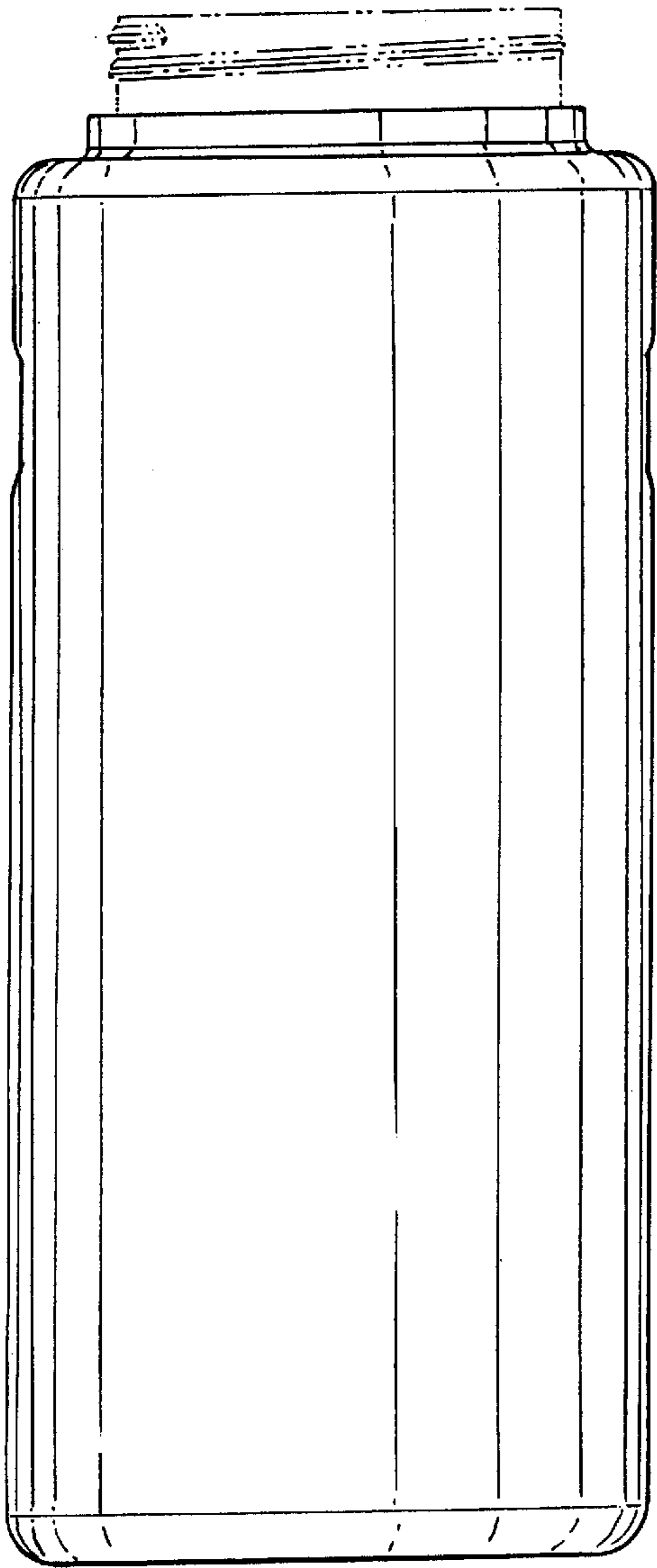

FIG. 3

FIG. 4

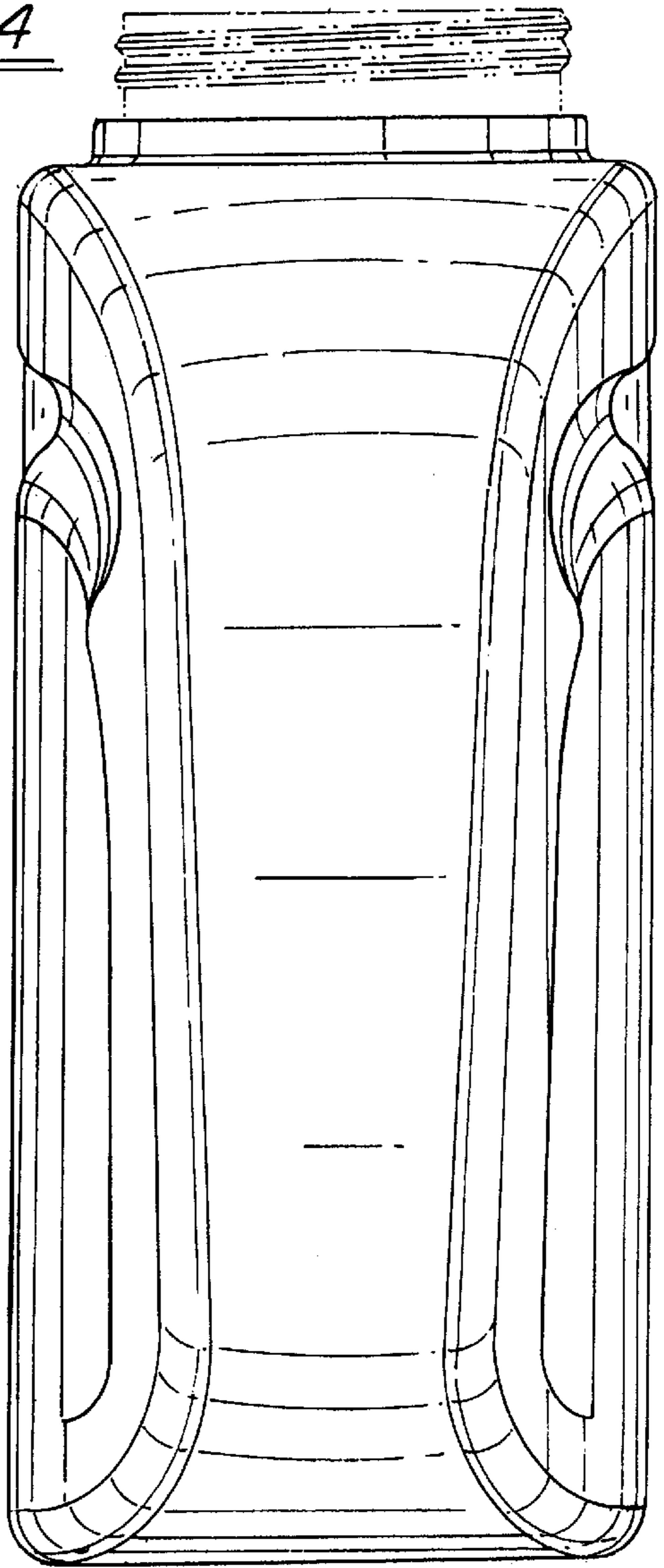

FIG. 6

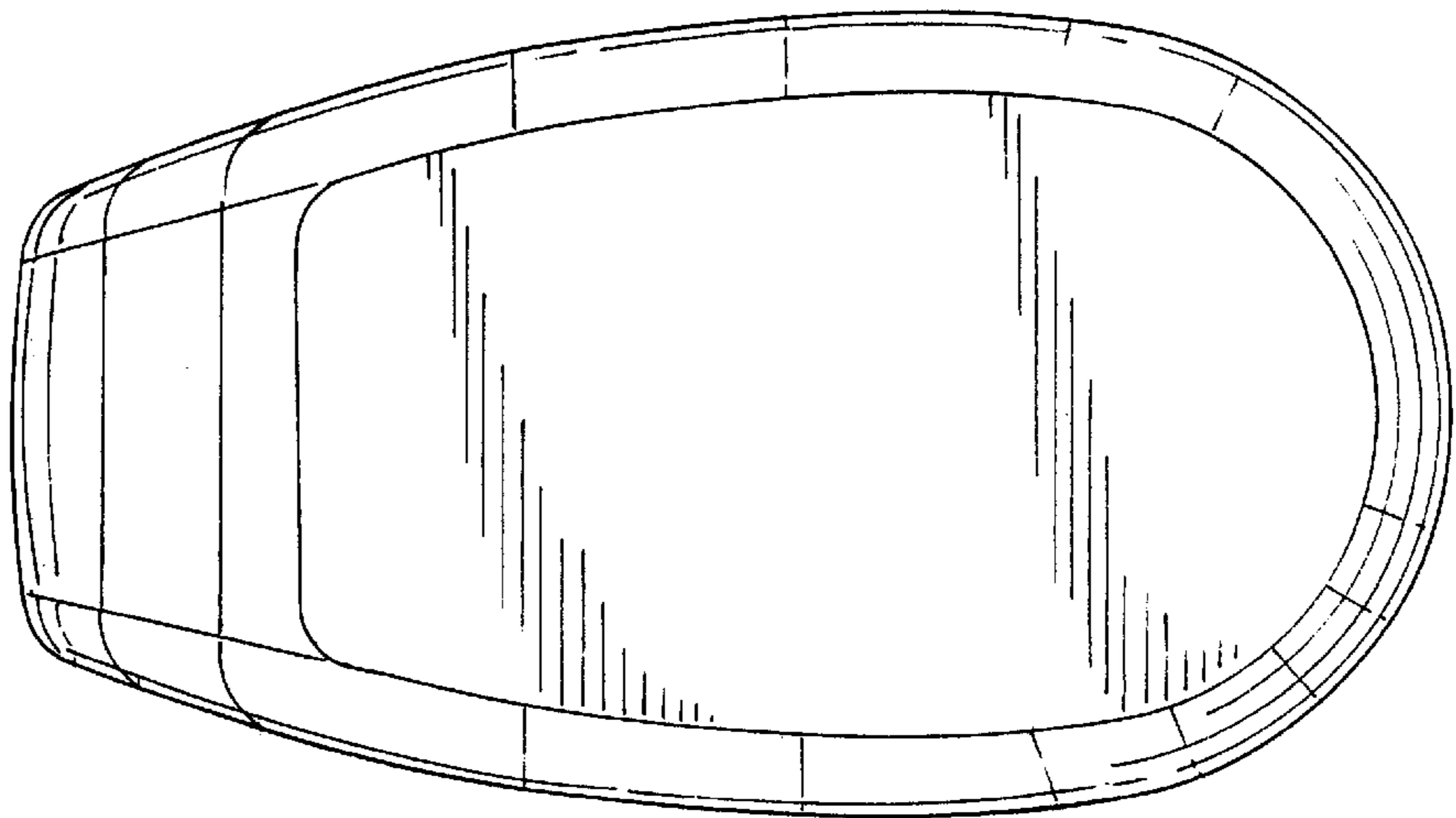

FIG. 7

