



US00D409053S

United States Patent [19]
Wong

[11] **Patent Number: Des. 409,053**

[45] **Date of Patent: ** May 4, 1999**

[54] **COLANDER**

[75] Inventor: **Vincent Wong**, Issaquah, Wash.

[73] Assignee: **DI 2000, Inc.**, Seattle, Wash.

[**] Term: **14 Years**

[21] Appl. No.: **29/088,830**

[22] Filed: **Jun. 1, 1998**

[51] **LOC (6) Cl.** **07-04**

[52] **U.S. Cl.** **D7/667**

[58] **Field of Search** D7/667, 668, 400;
210/464, 470, 473, 498, 499

[56] **References Cited**

U.S. PATENT DOCUMENTS

- D. 199,320 10/1964 Swett D7/667
- D. 390,757 2/1998 Wold et al. D7/667

OTHER PUBLICATIONS

Ekco Housewares Co. Catalog, No. PL-13461, p. 74, colander TM00280, Oct. 1981.

Primary Examiner—Terry A. Wallace

Attorney, Agent, or Firm—Zackery Legal Group

[57] **CLAIM**

An ornamental design for a colander, as shown and described.

DESCRIPTION

FIG. 1 is a perspective view of a colander showing my new design;
 FIG. 2 is a front elevation view thereof;
 FIG. 3 is a rear elevation view thereof;
 FIG. 4 is a right side elevation view thereof;
 FIG. 5 is a left side elevation view thereof;
 FIG. 6 is a top plan view thereof;
 FIG. 7 is a bottom plan view thereof;
 FIG. 8 is a perspective view of an alternate embodiment of FIG. 1;
 FIG. 9 is a front elevation view of FIG. 8;
 FIG. 10 is a rear elevation view of FIG. 8;
 FIG. 11 is a right side elevation view of FIG. 8;
 FIG. 12 is a left side elevation view of FIG. 8;
 FIG. 13 is a top plan view of FIG. 8; and,
 FIG. 14 is a bottom plan view of FIG. 8.

1 Claim, 10 Drawing Sheets

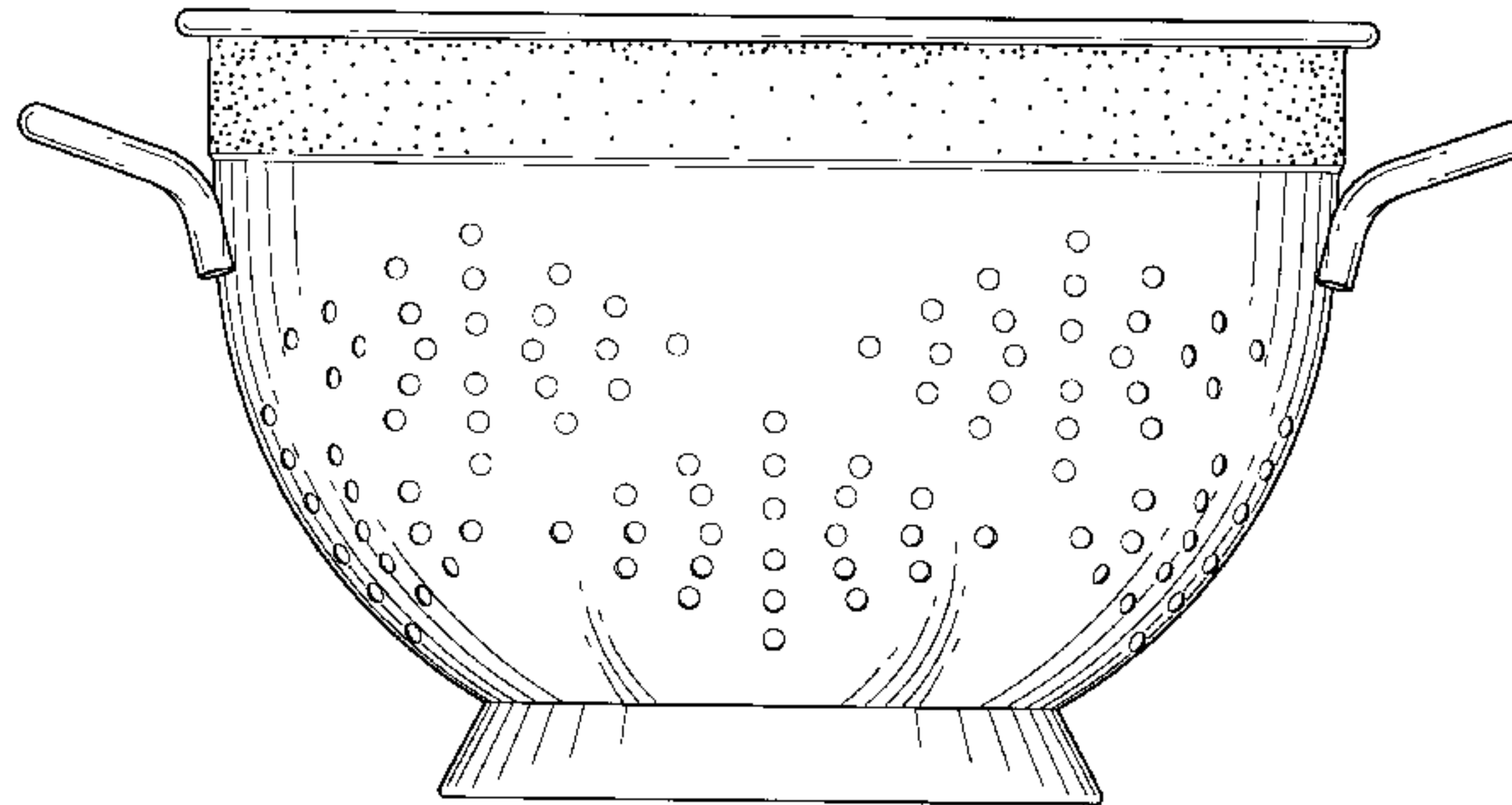
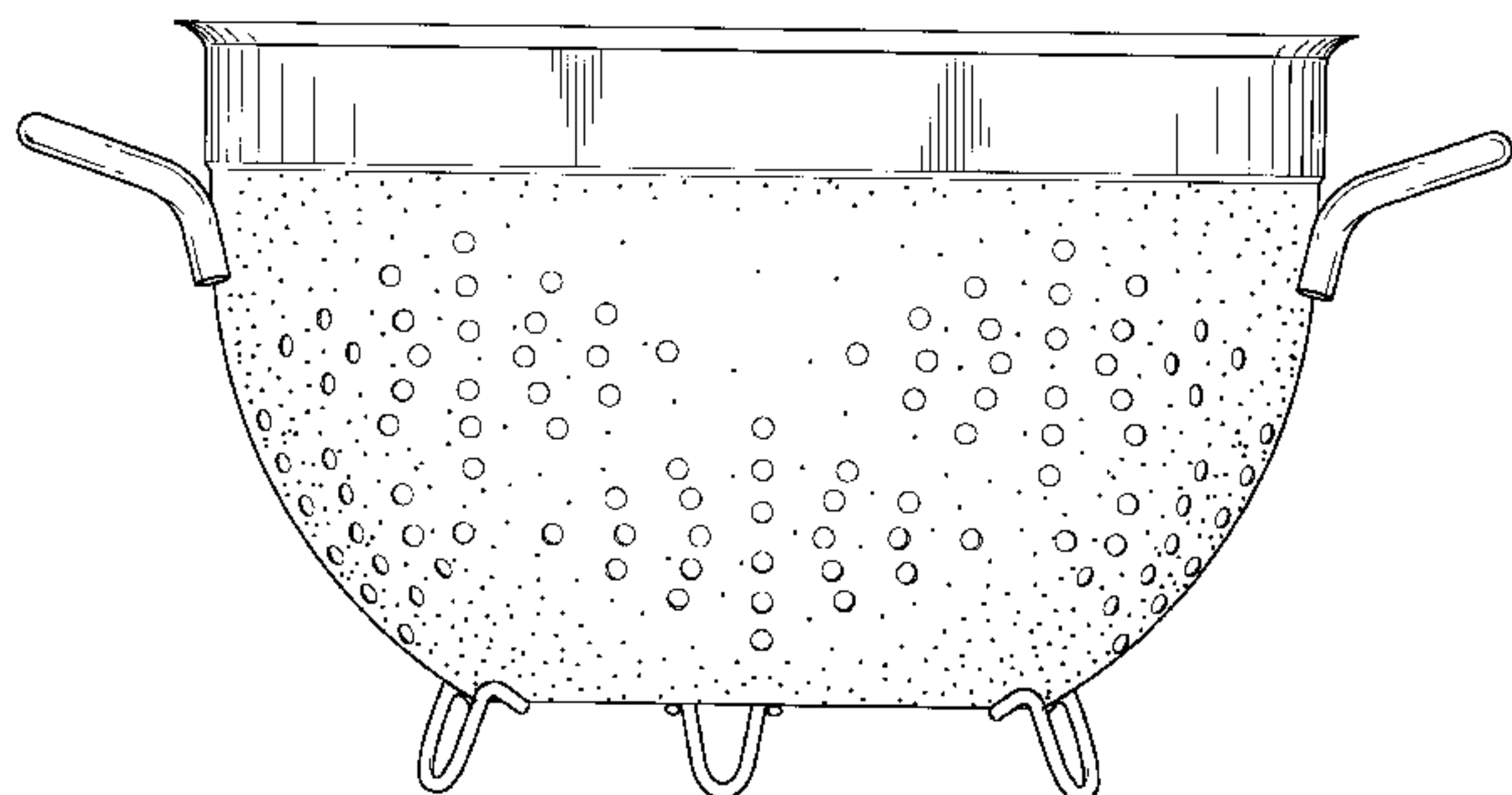

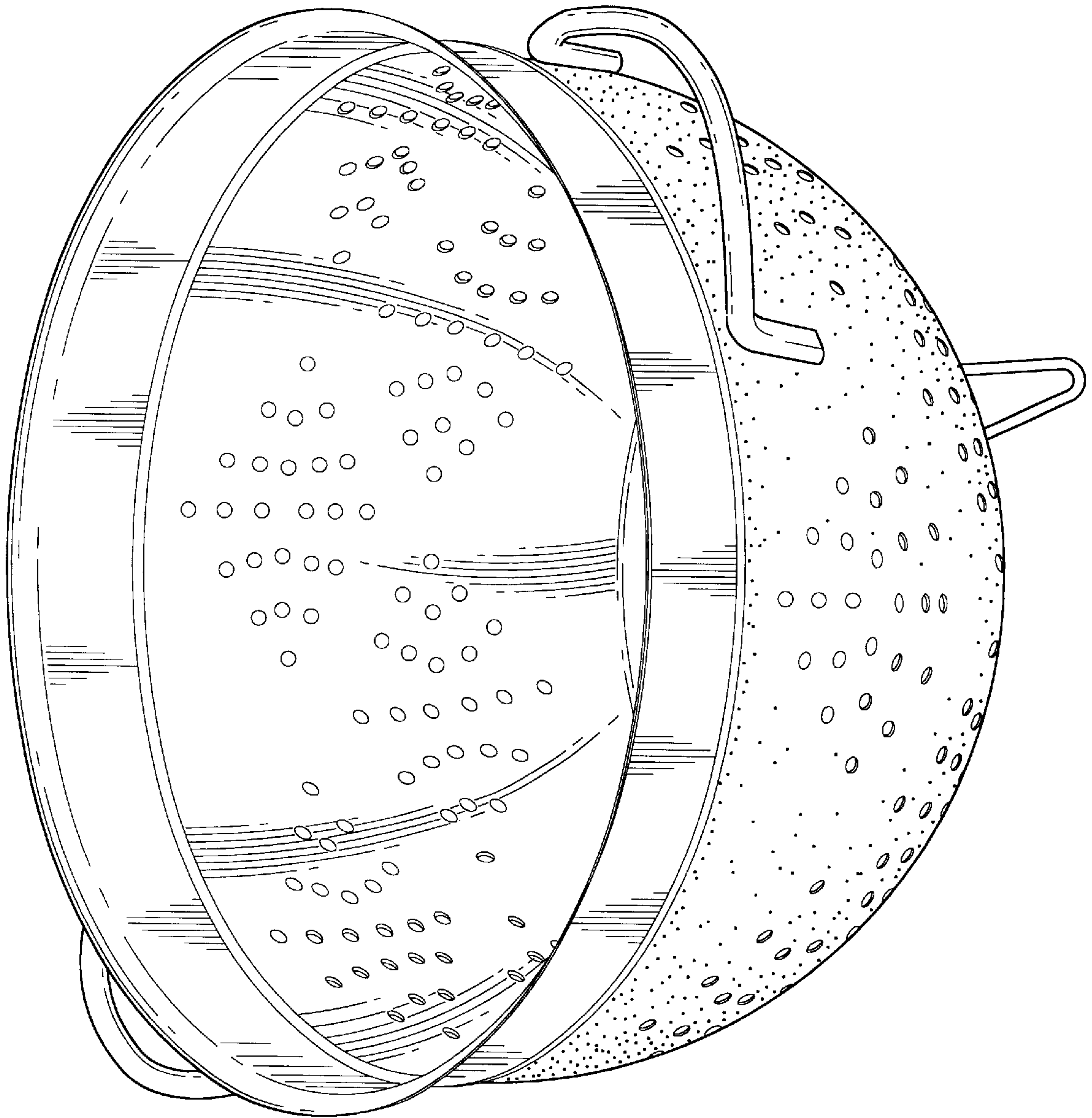

FIG. 1

FIG. 2

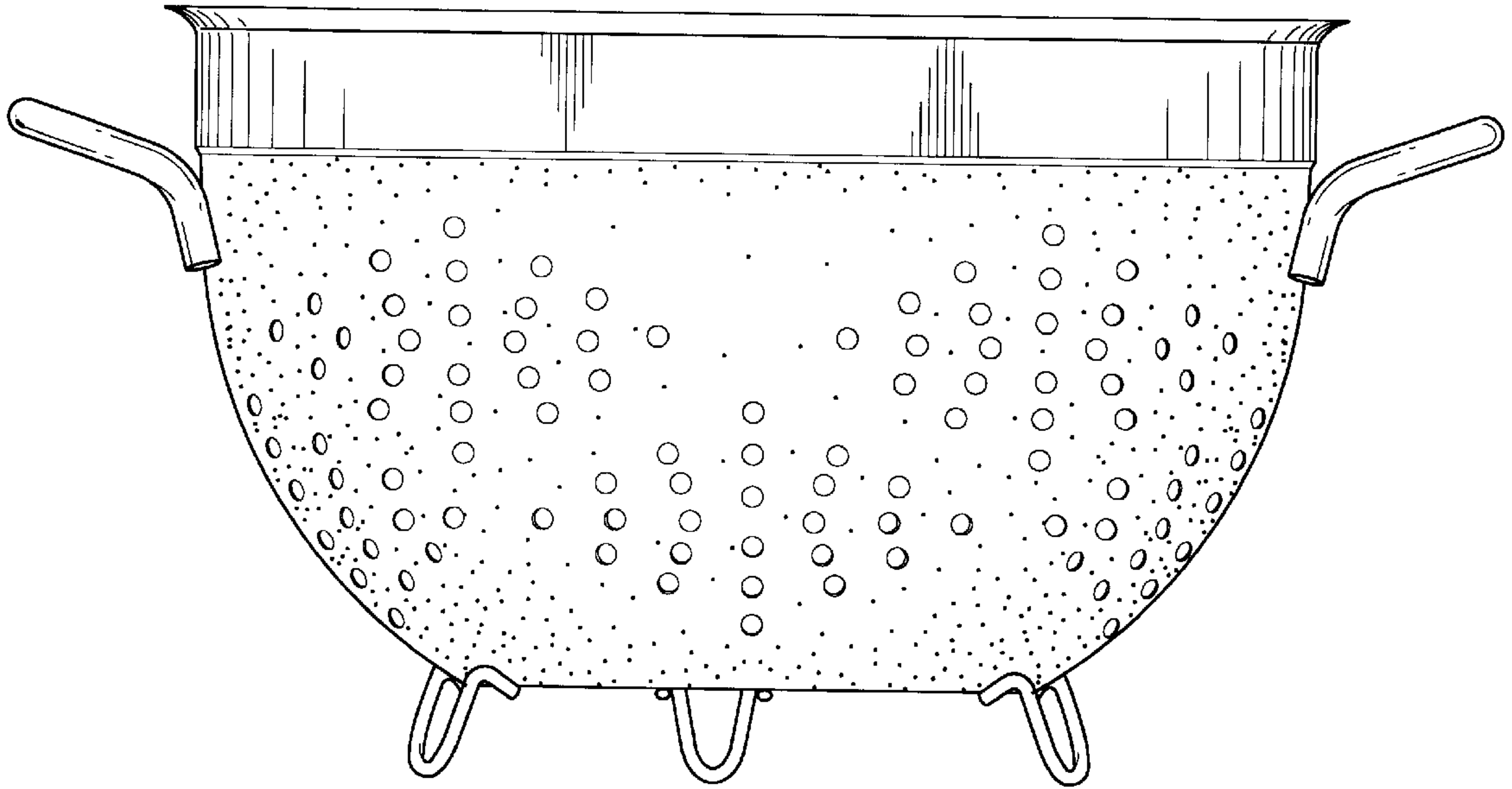

FIG. 3

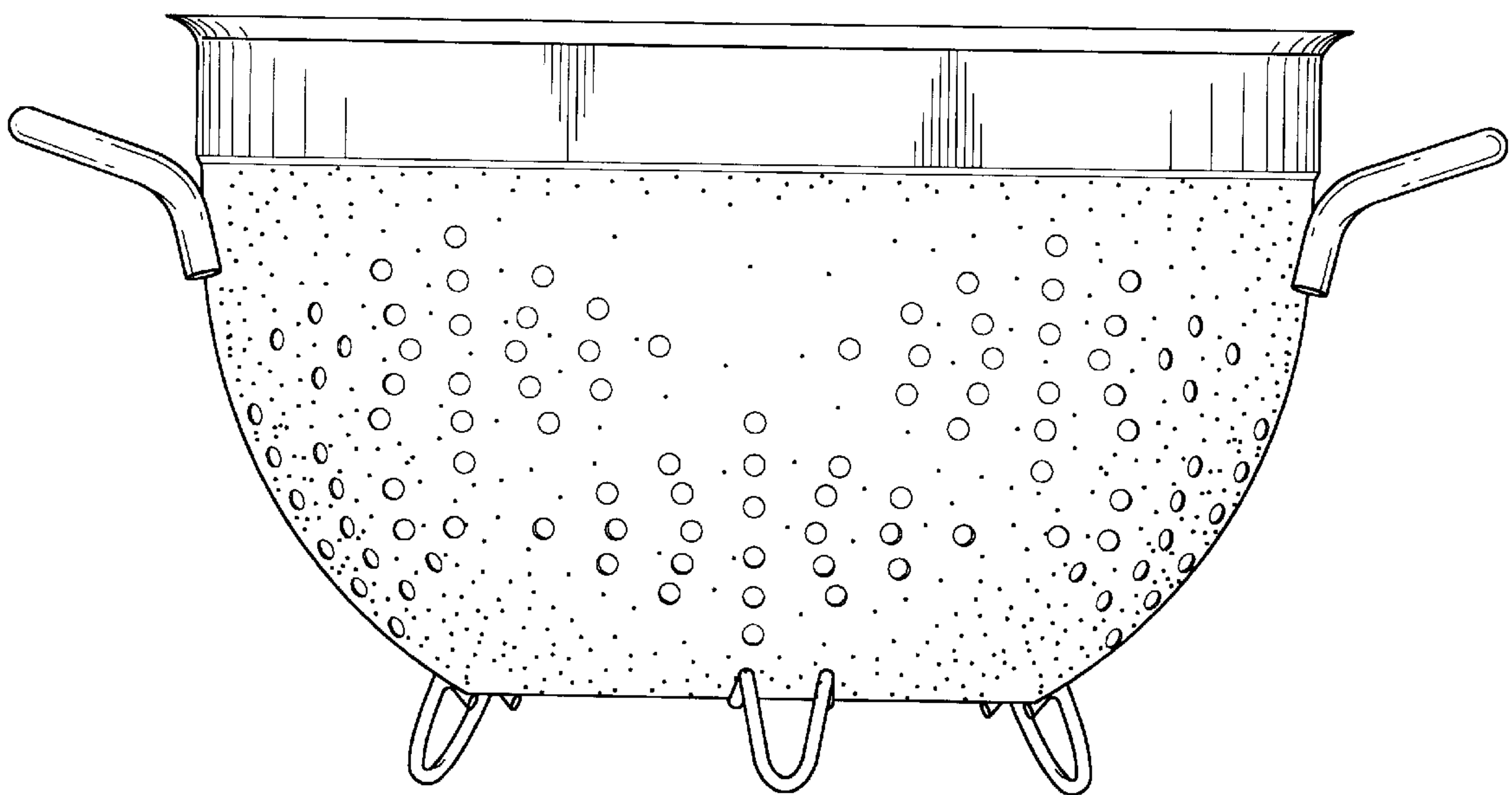

FIG. 4

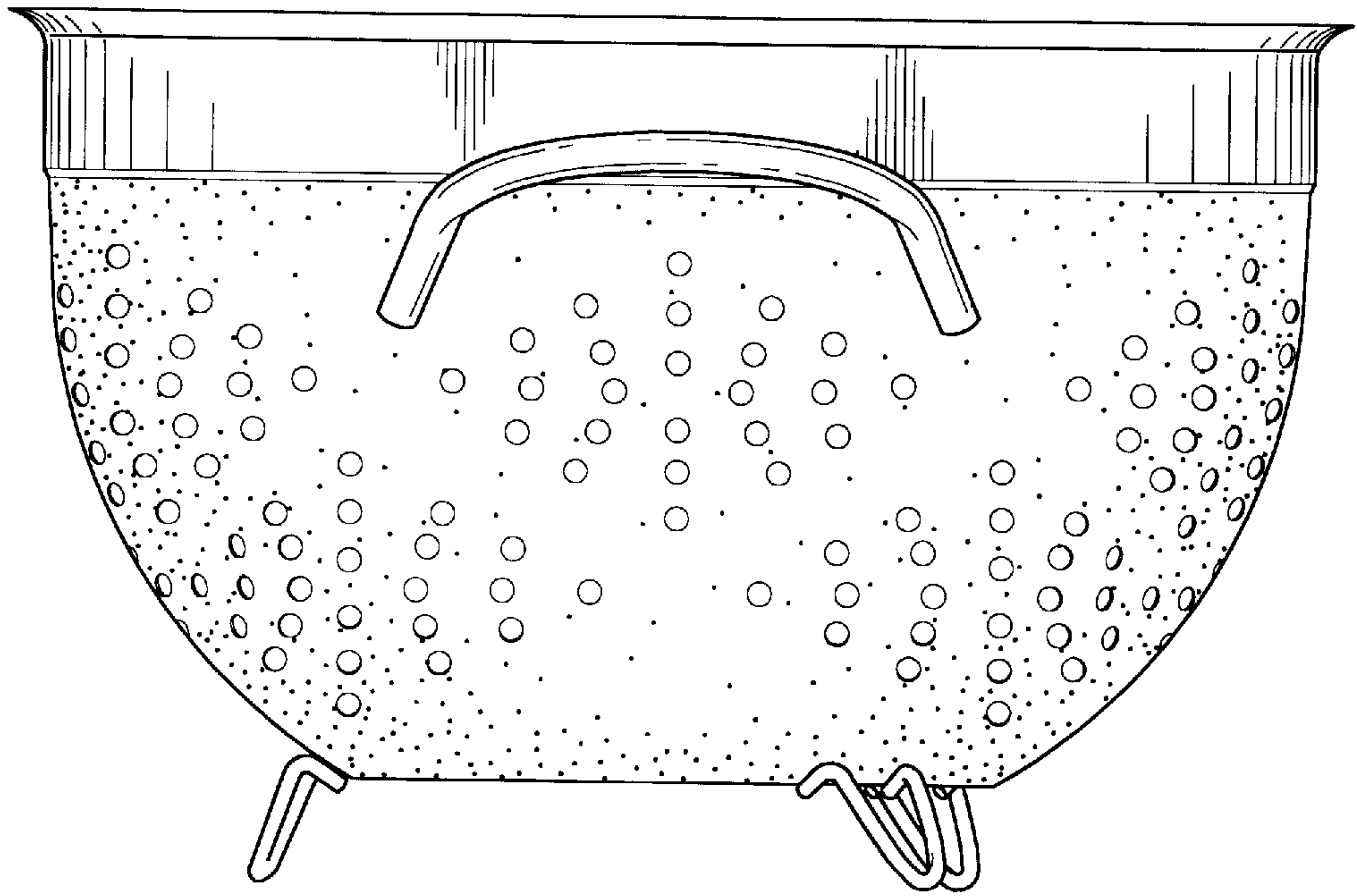

FIG. 5

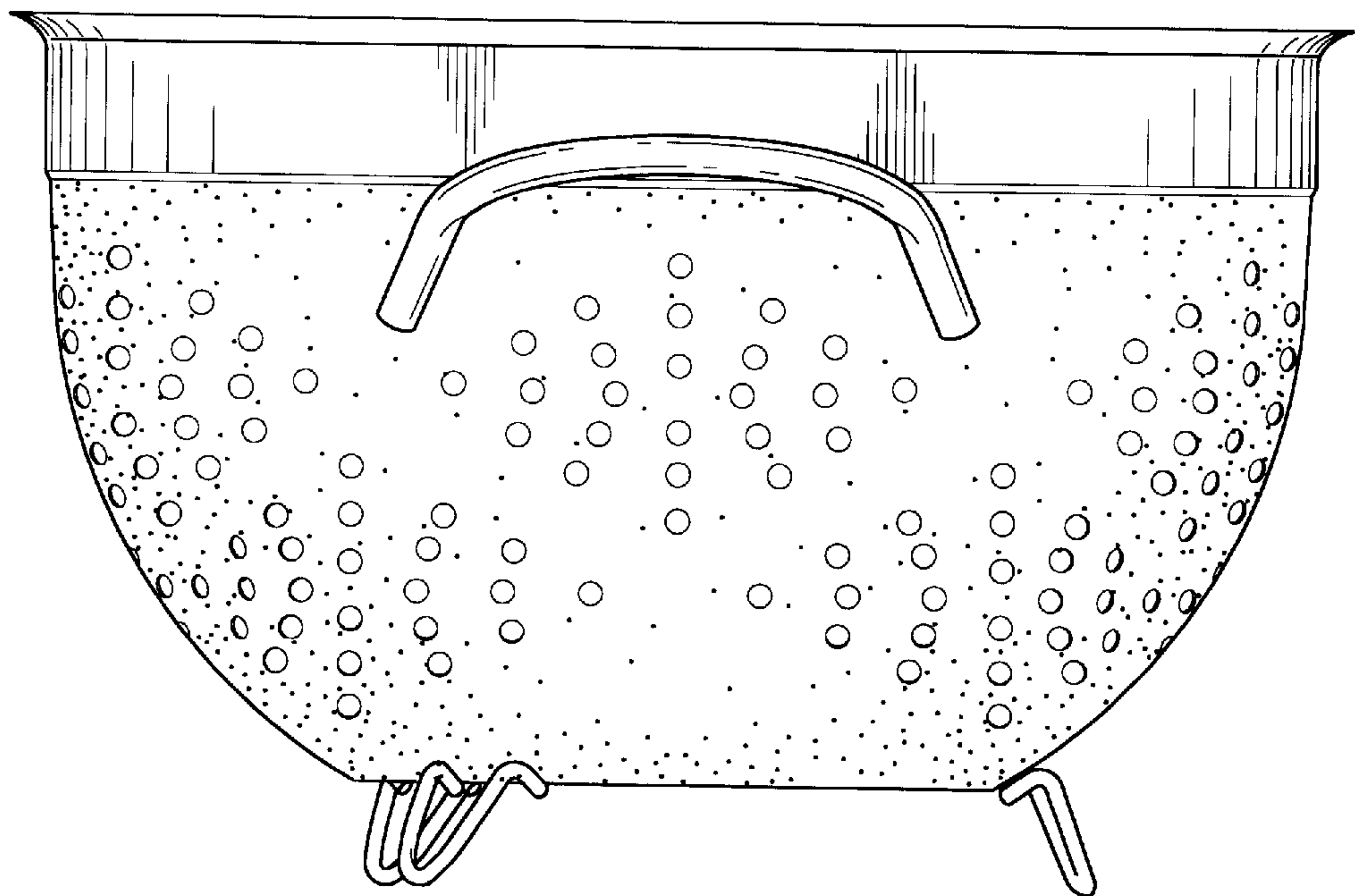

FIG. 6

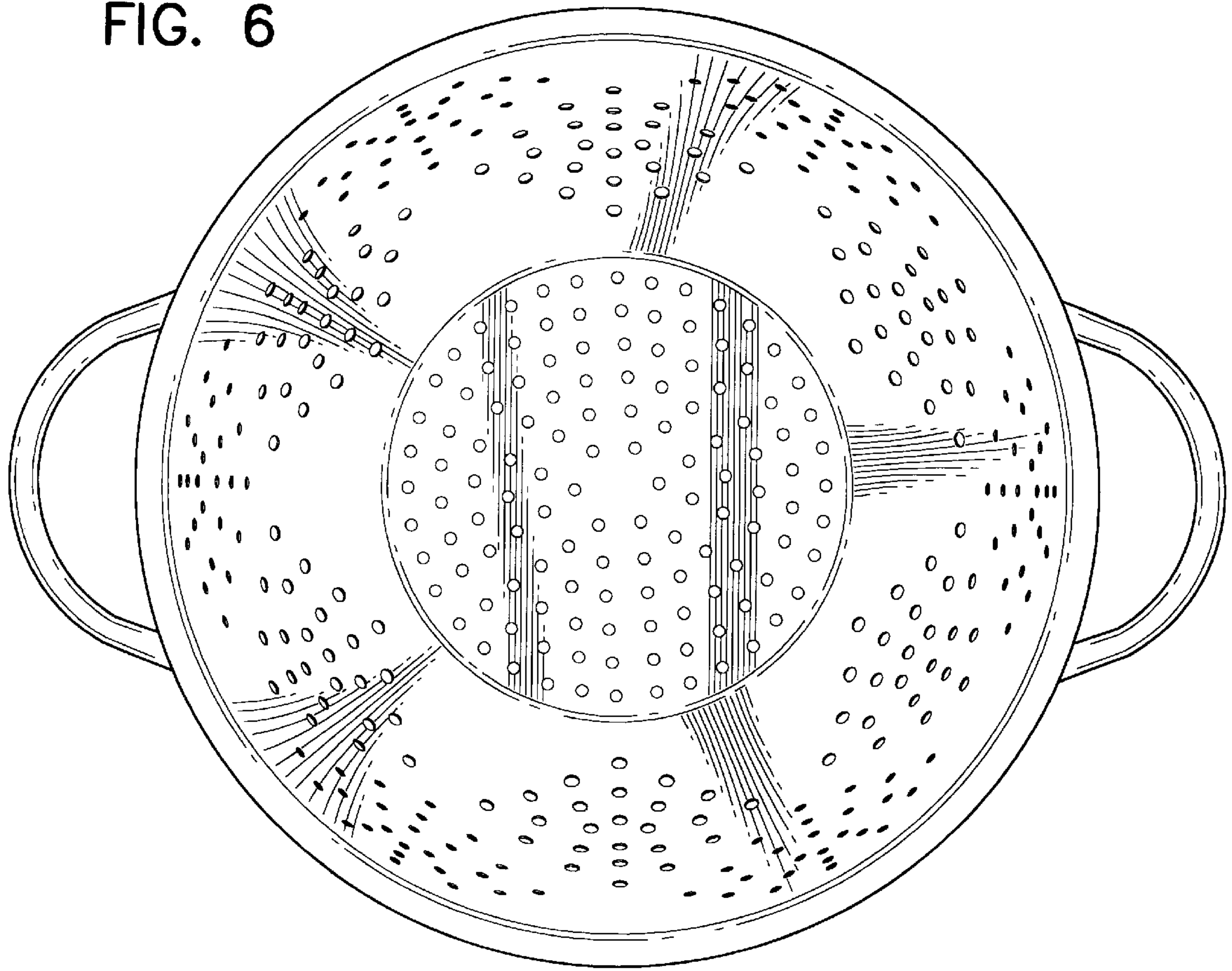
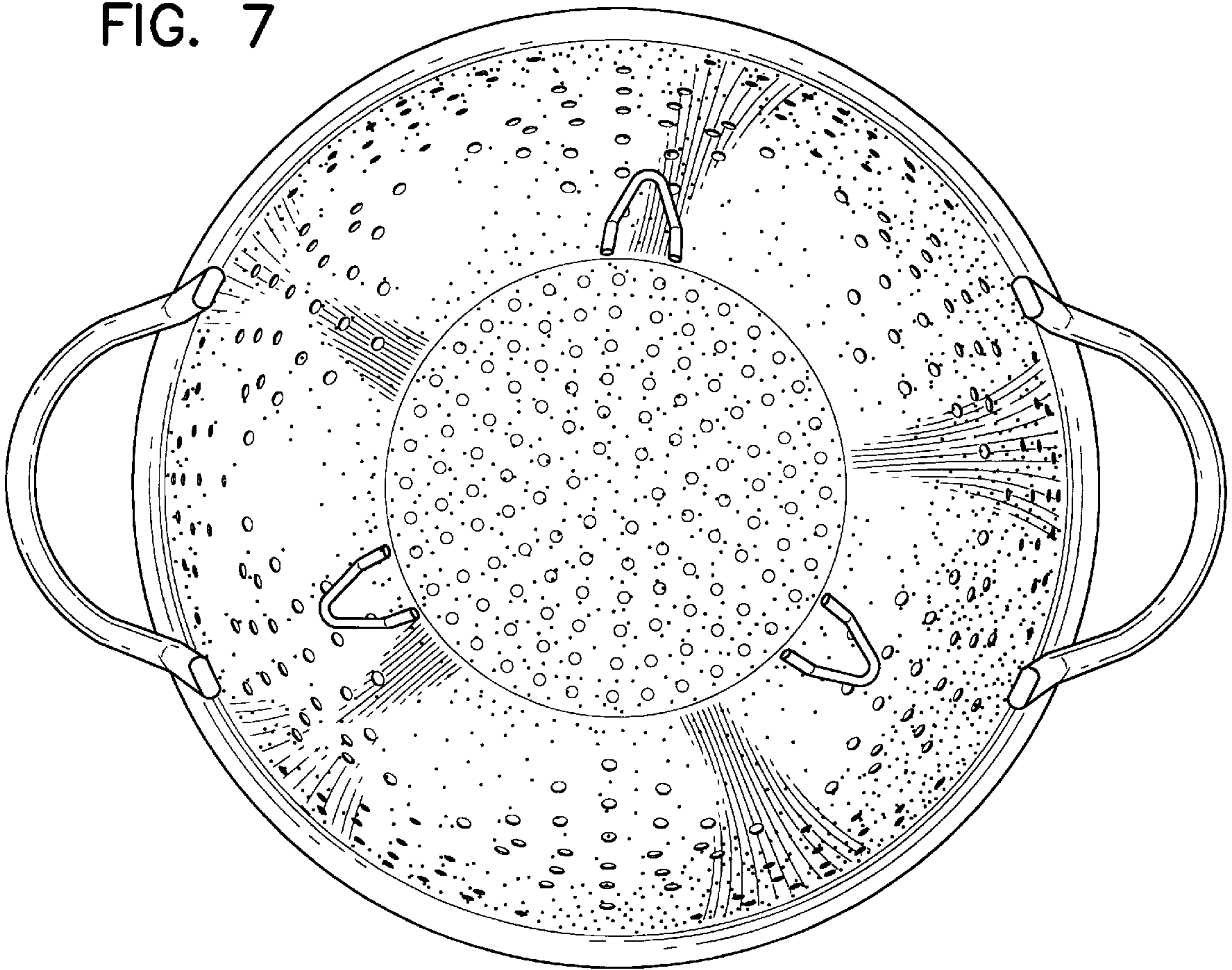

FIG. 7



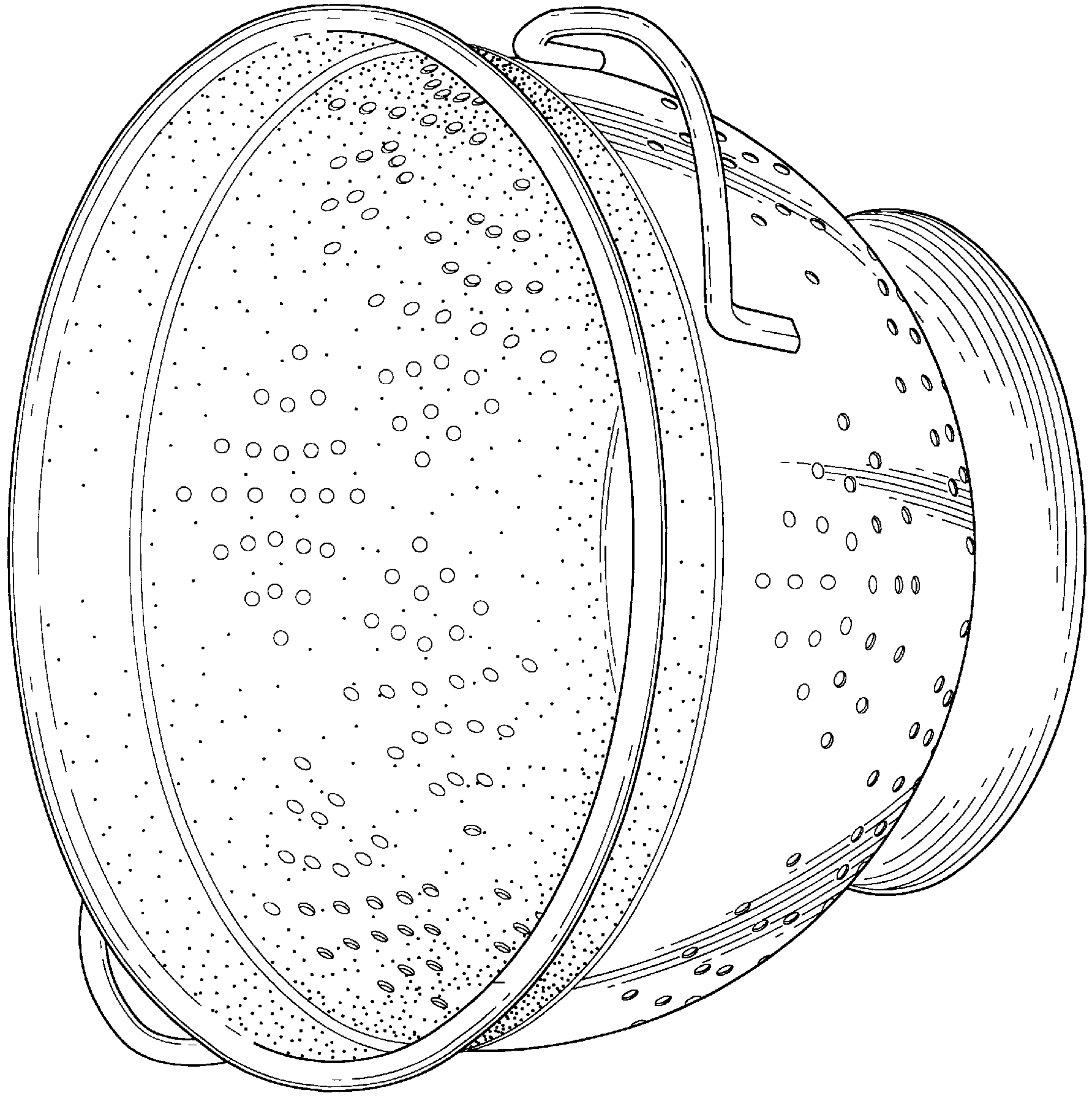

FIG. 8

FIG. 9

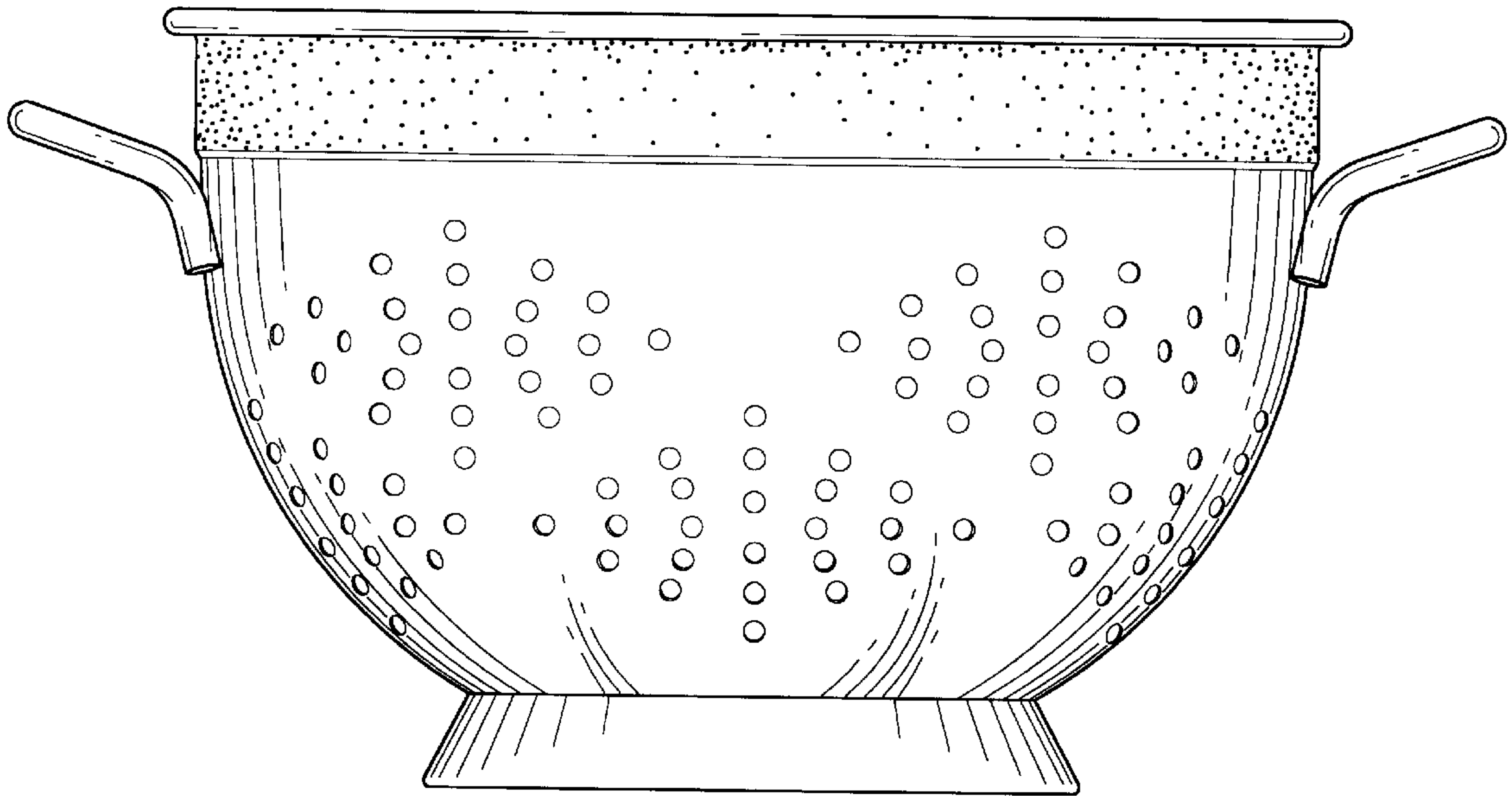

FIG. 10

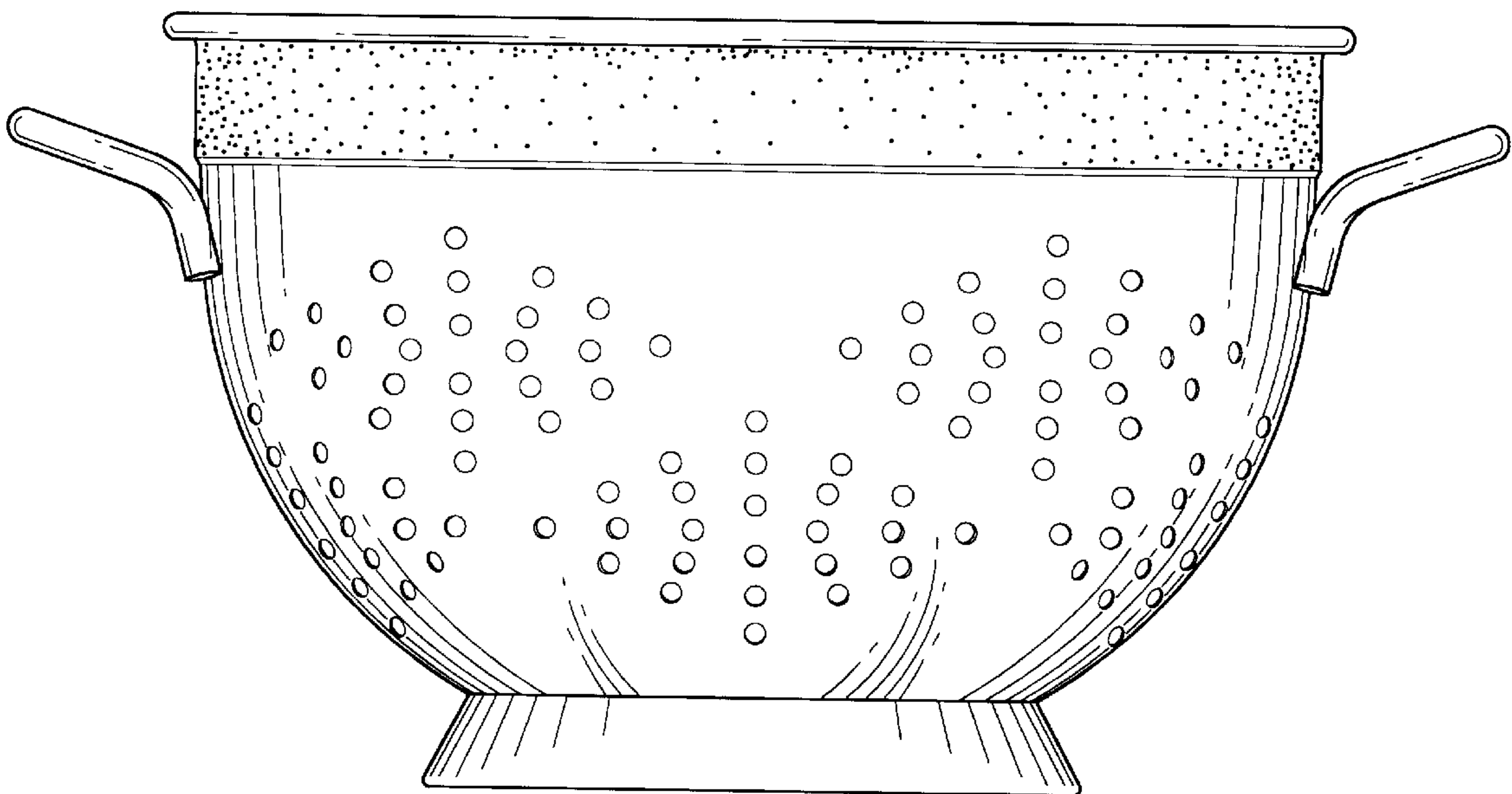

FIG. 11

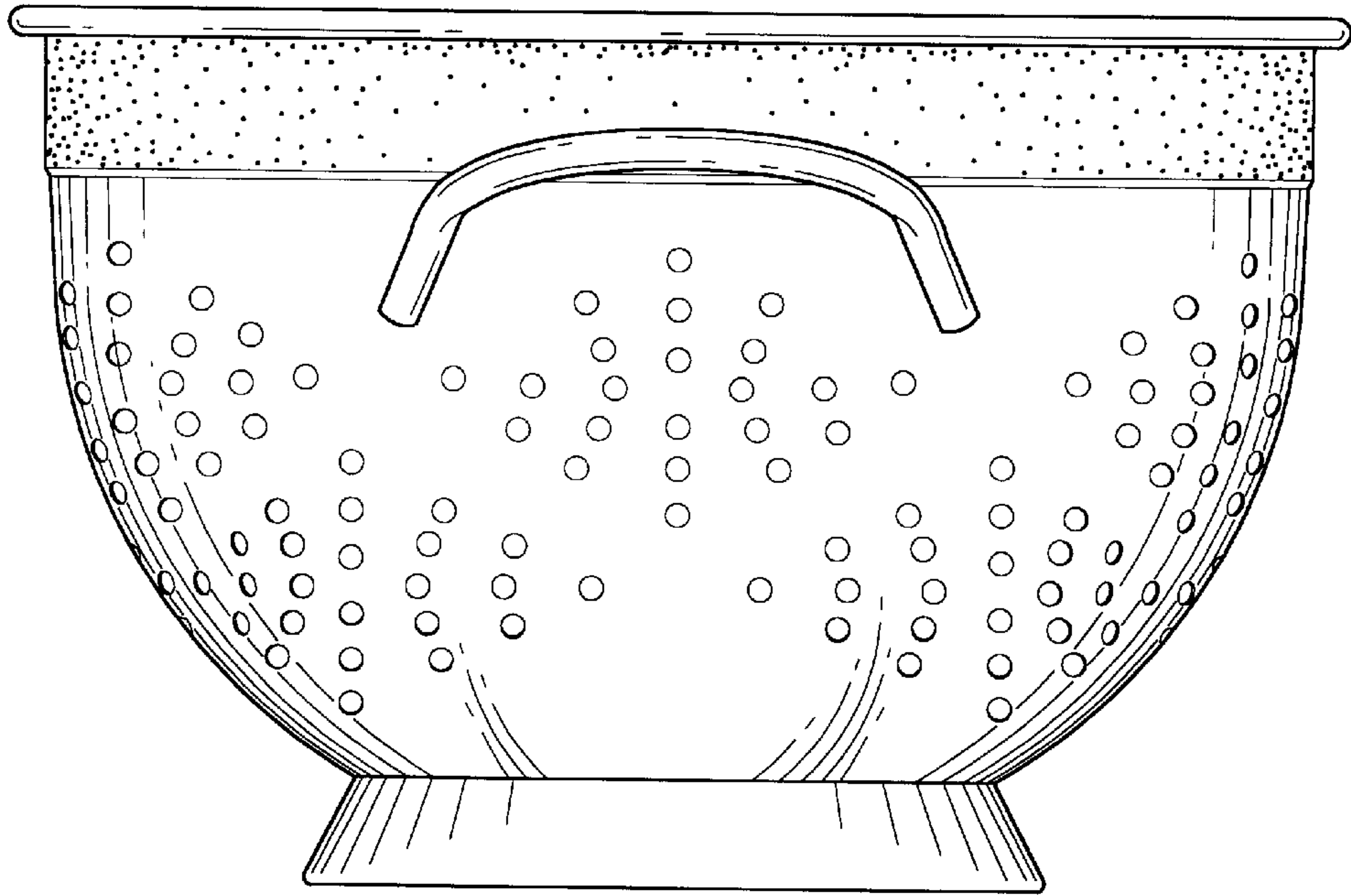

FIG. 12

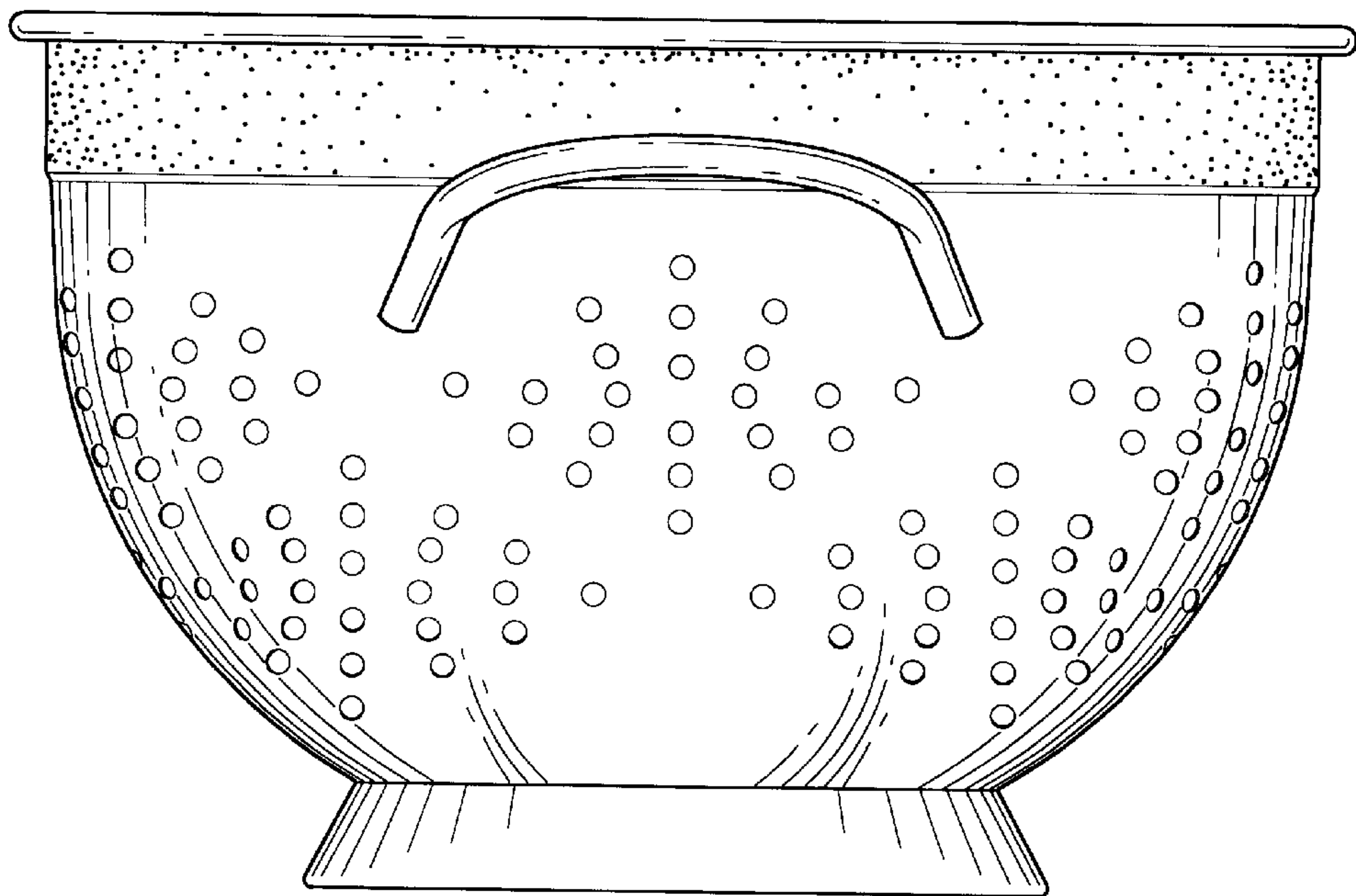

FIG. 13

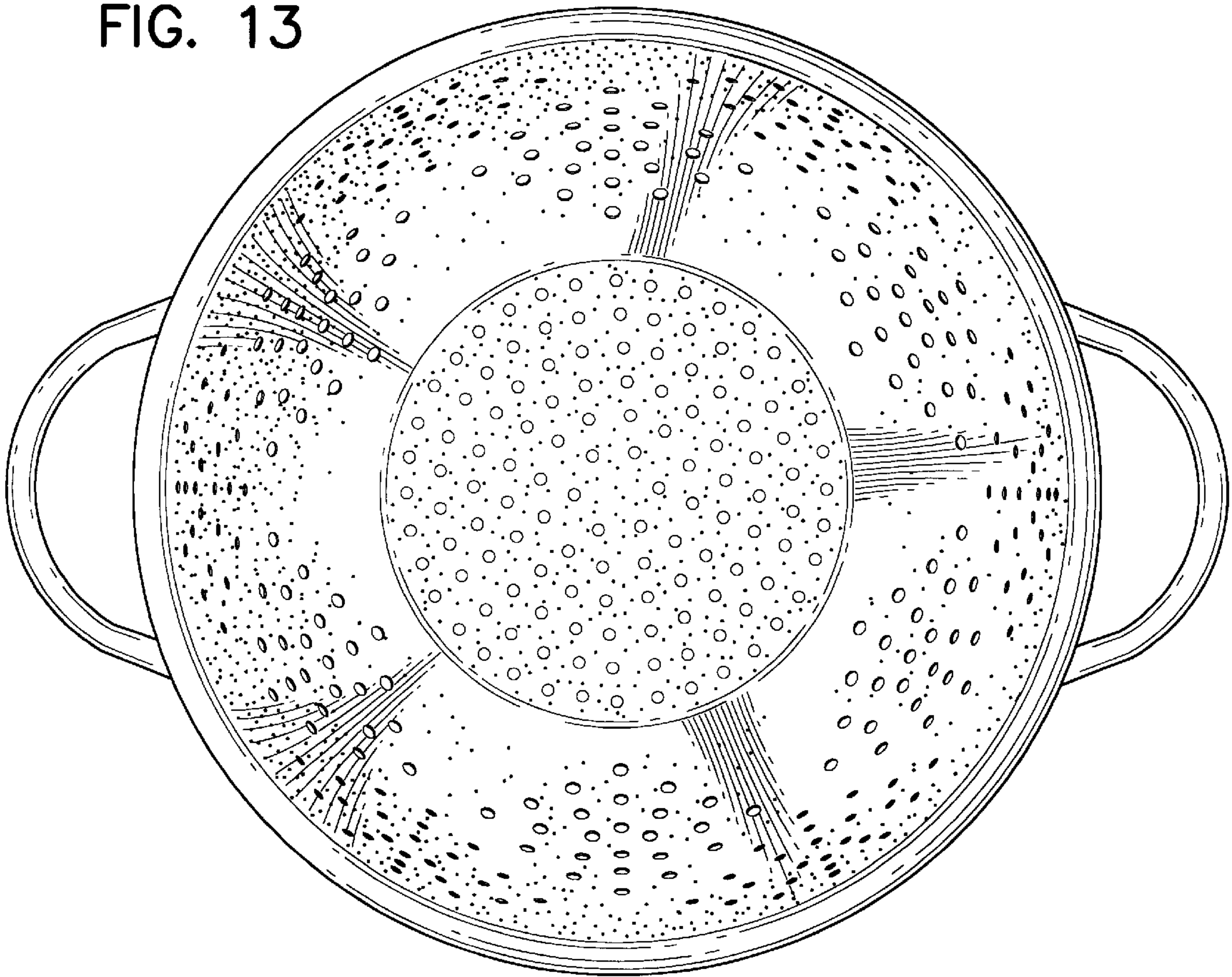

FIG. 14

