



US00D409007S

United States Patent [19]
Osterweil-Glaz et al.

[11] **Patent Number: Des. 409,007**
[45] **Date of Patent: ** May 4, 1999**

[54] **CHILD SEAT**

4,783,118 11/1988 Ryan et al. 297/3

[76] Inventors: **Batya Osterweil-Glaz**, 152 Hillair Cir.,
White Plains, N.Y. 10605; **Pessi Margulies**, 12 Long Pond Rd., Armonk,
N.Y. 10504

Primary Examiner—Gary D. Watson
Attorney, Agent, or Firm—Helfgott & Karas, P.C.

[**] Term: **14 Years**

[57] **CLAIM**

The ornamental design for a child seat, as shown and described.

[21] Appl. No.: **29/074,087**

DESCRIPTION

[22] Filed: **Jul. 28, 1997**

FIG. 1 is a right side perspective view of a child seat in a first orientation showing our new design;
FIG. 2 is a left side elevation view, the right side being a mirror image thereof;
FIG. 3 is a front side elevation view thereof;
FIG. 4 is a left side perspective view thereof with the seat portion and back portion shown in an alternate position;
FIG. 5 is a left side perspective view thereof;
FIG. 6 is a left side view of the child seat thereof with the removable tray in place;
FIG. 7 is a perspective view of the child seat in a second orientation shown as a rocker; and,
FIG. 8 is a perspective view of the child seat in a third orientation shown as a desk.
The broken lines shown in FIG. 8 are for illustrative purposes only and form no part of the claimed design.
The removable tray shown in FIG. 6 has not been shown in any of the other views.

[51] **LOC (6) Cl.** **06-01**

[52] **U.S. Cl.** **D6/335; D6/336; D6/339**

[58] **Field of Search** D6/334, 335, 336,
D6/338, 339, 344, 348, 367, 500, 501,
502; 297/1, 3, 174, 271.5

[56] **References Cited**

U.S. PATENT DOCUMENTS

D. 144,404	4/1946	Mabry	D6/336
D. 147,581	9/1947	Coulter	D6/336
D. 213,773	4/1969	Beardmore	D6/335
D. 218,027	7/1970	Obermeyer	D6/338
D. 234,652	4/1975	Schug	D6/335
D. 248,516	7/1978	Johansson	D6/335
D. 339,001	9/1993	Schiffman	D6/348
D. 357,128	4/1995	Watson et al.	D6/335
2,440,979	5/1948	Schneider	D6/335
3,879,083	4/1975	Olsson	D6/335

1 Claim, 4 Drawing Sheets

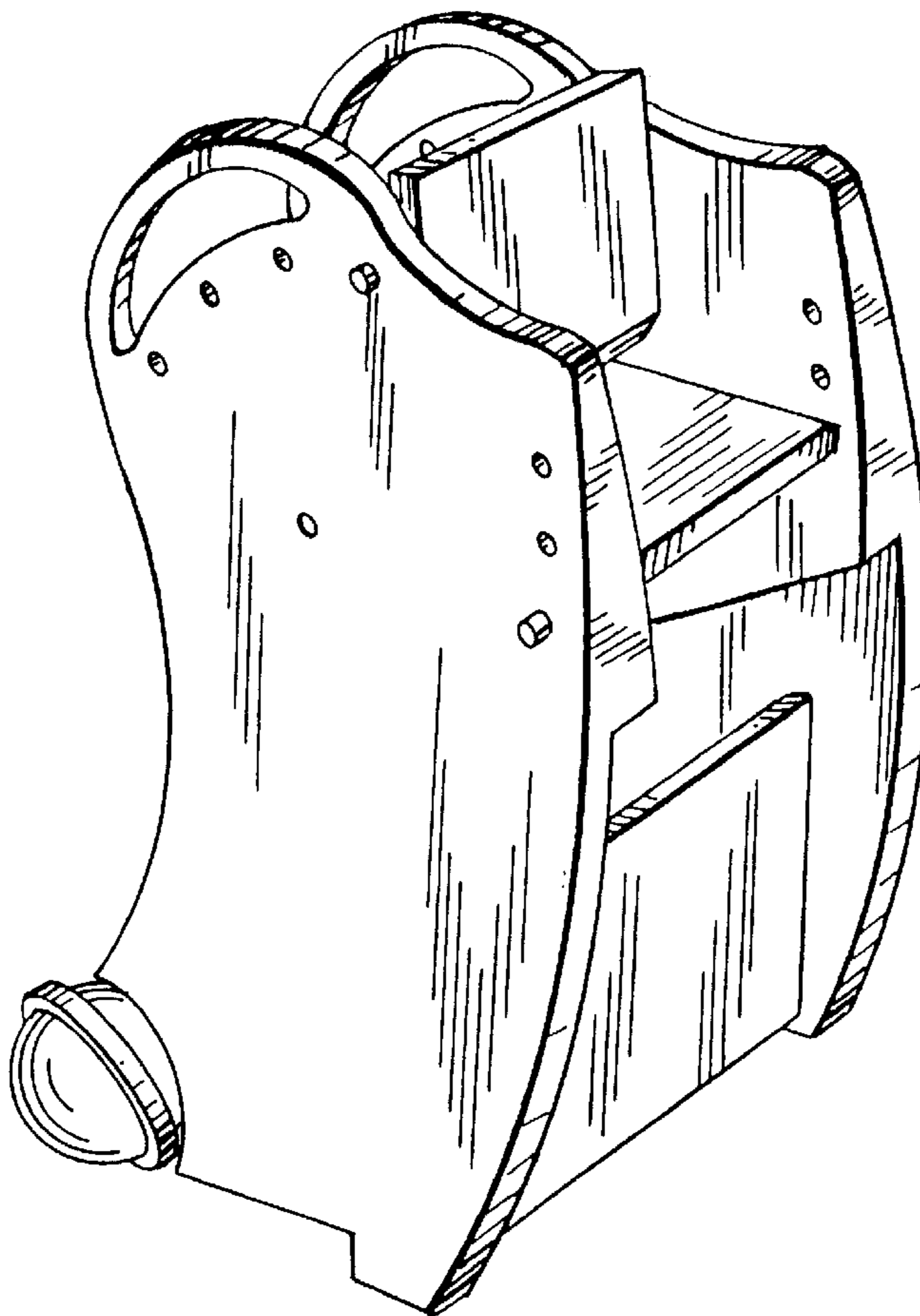

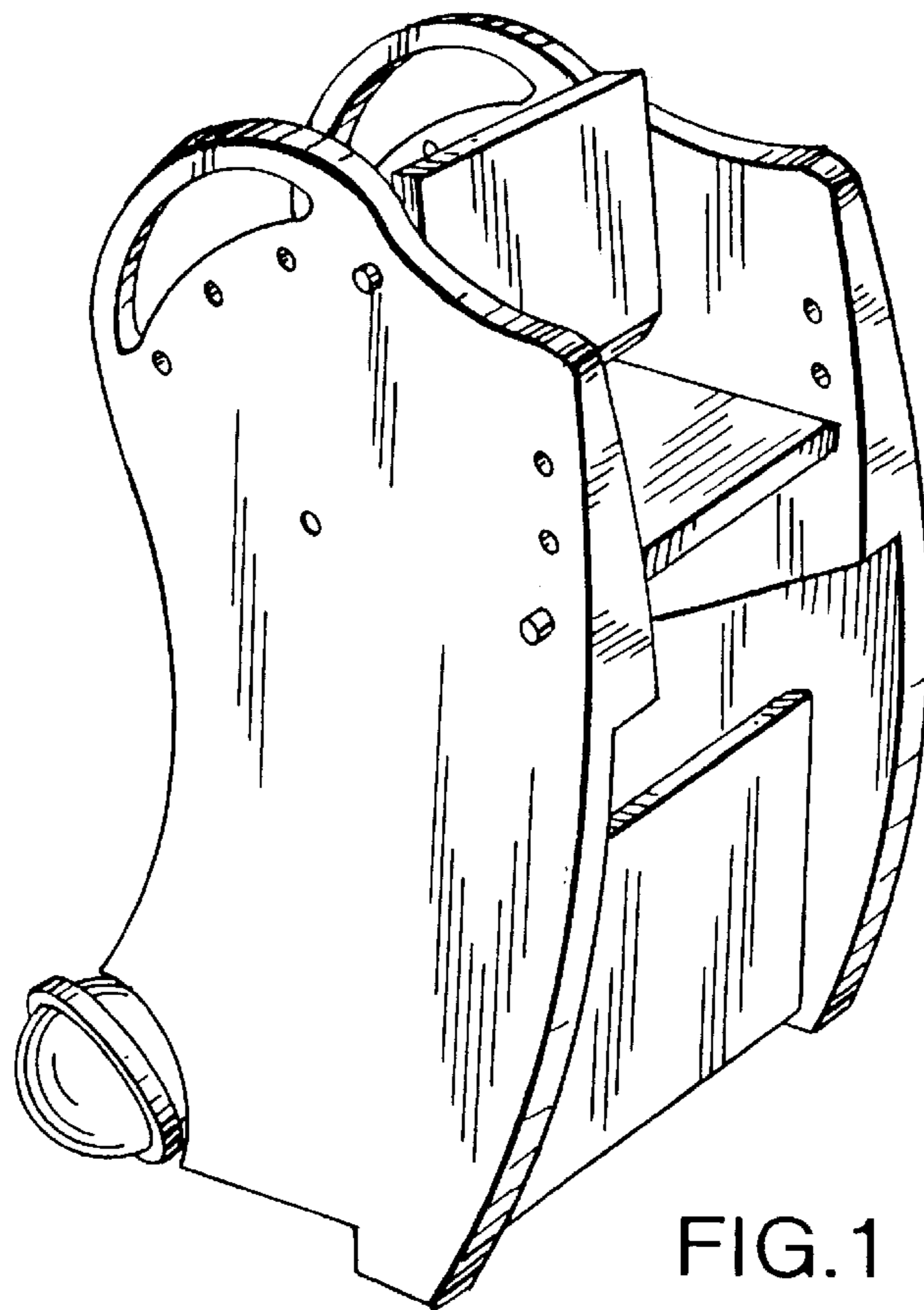

FIG. 1

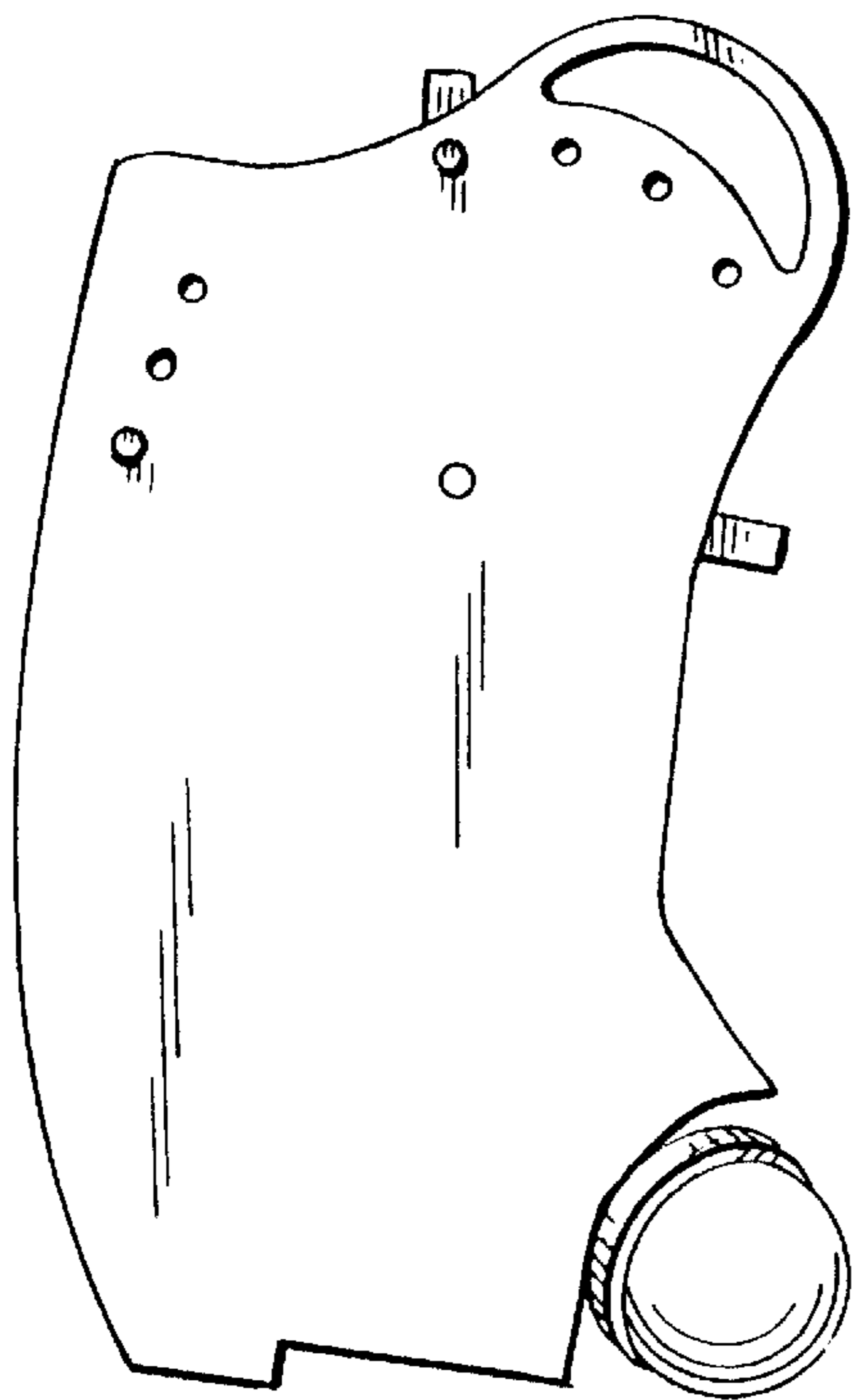

FIG. 2

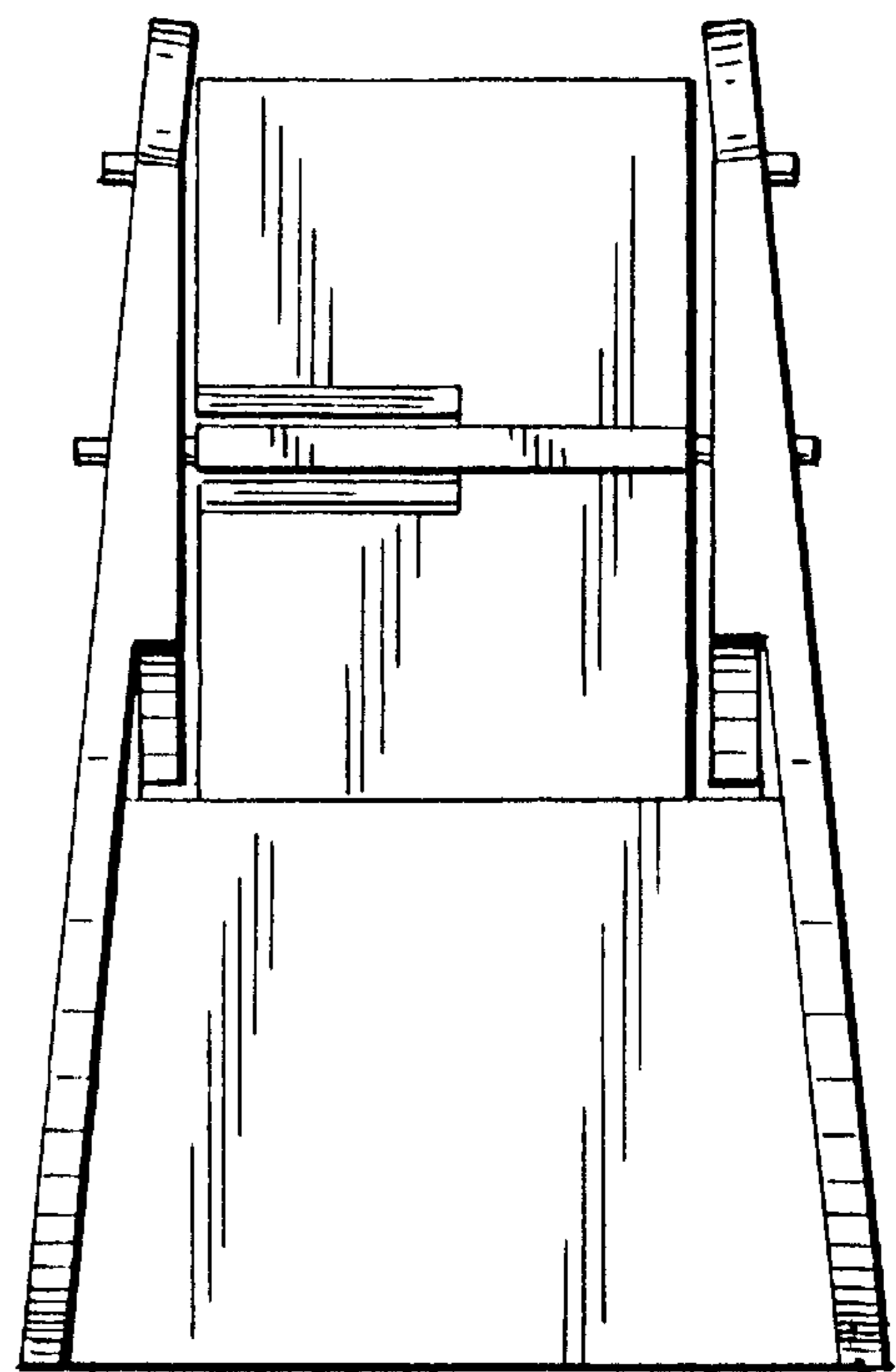

FIG. 3

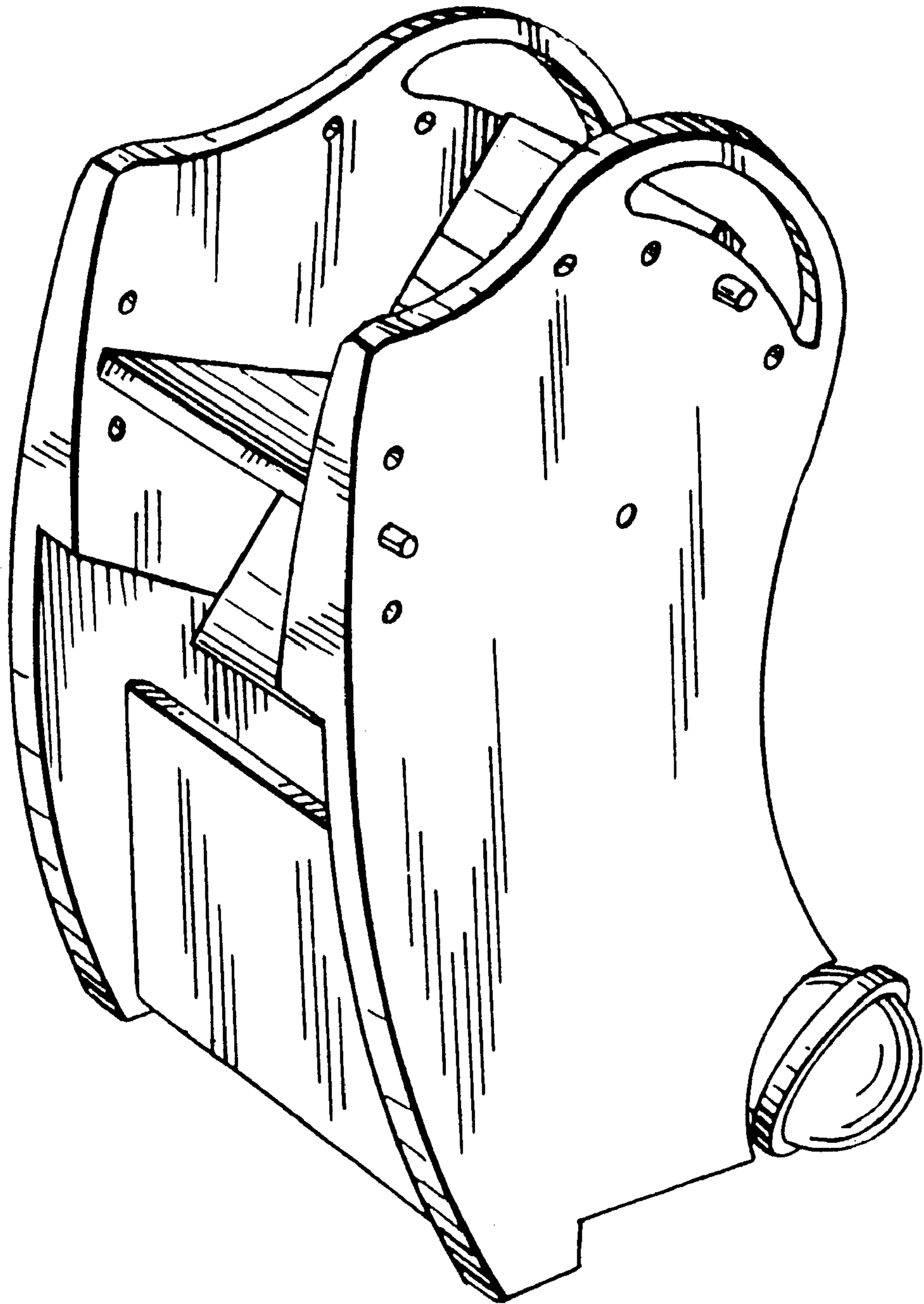

FIG. 4

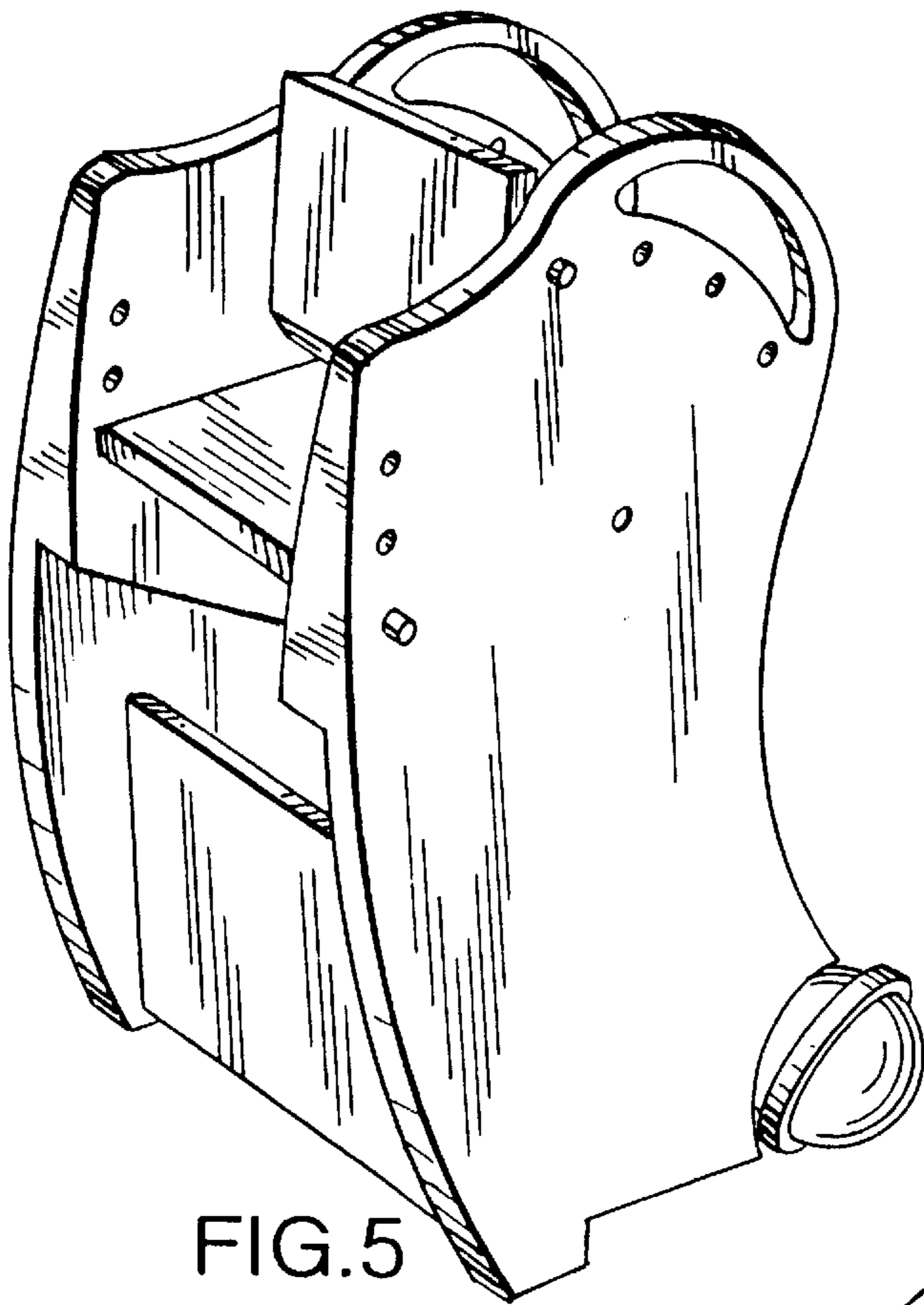

FIG.5

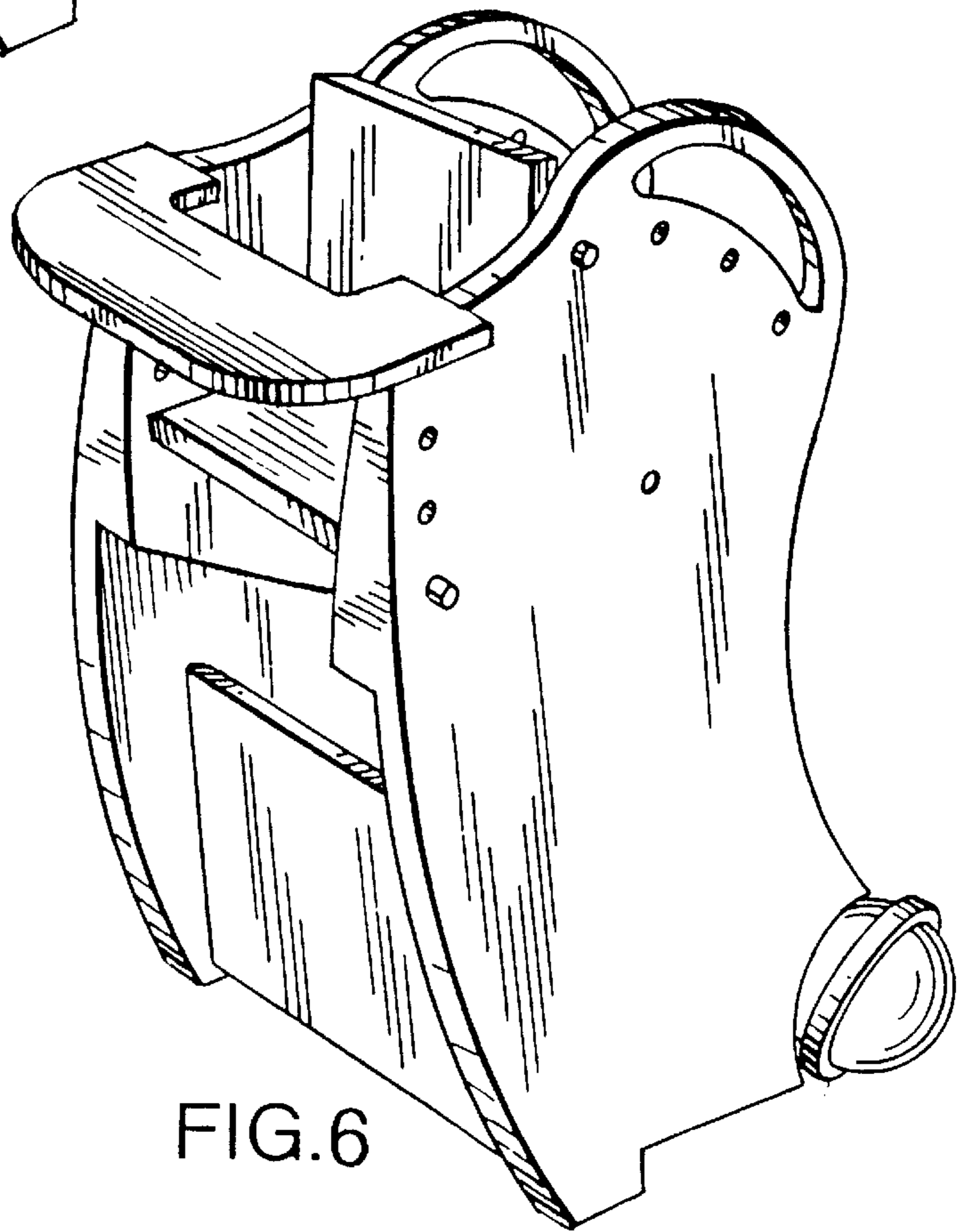

FIG.6

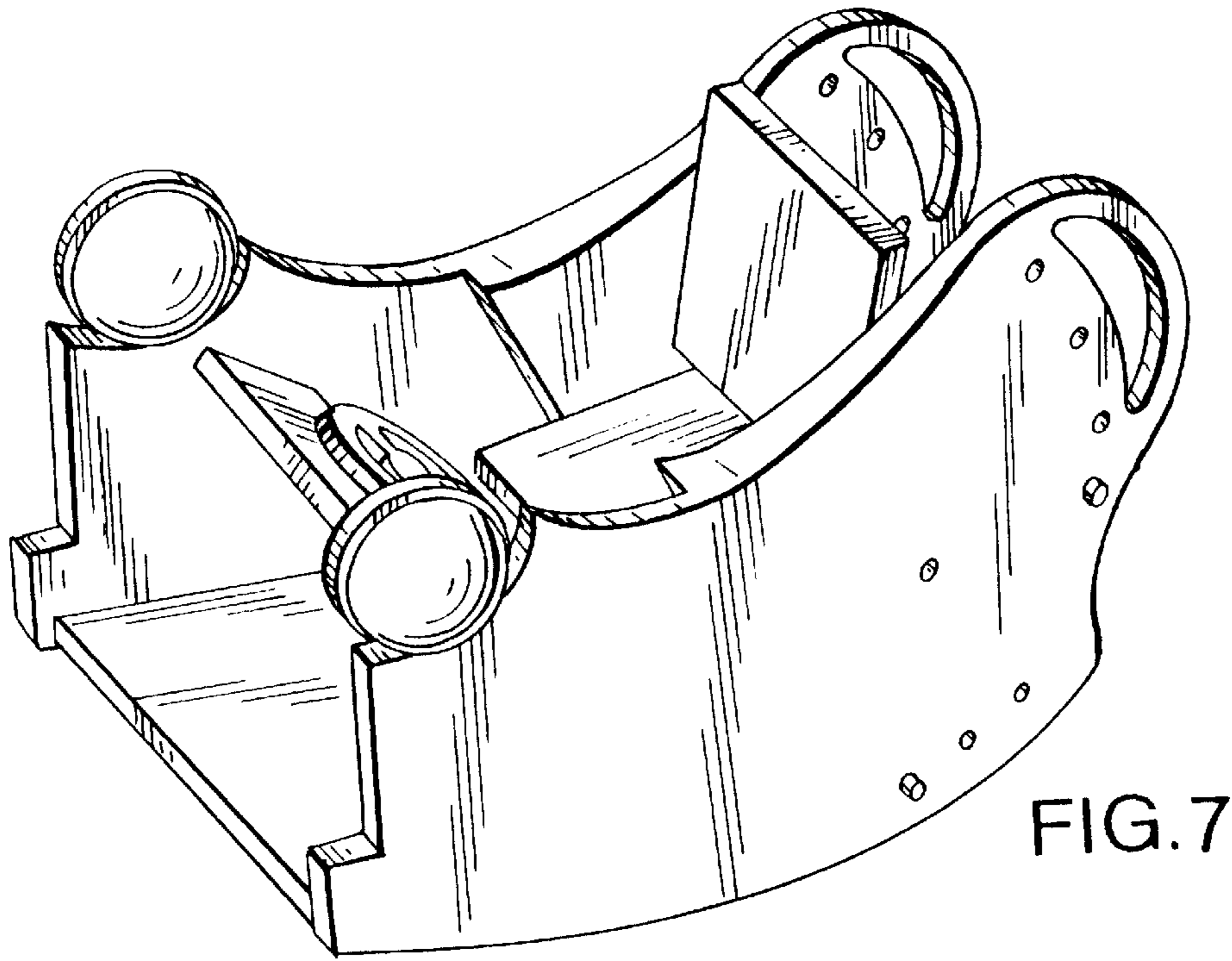

FIG. 7

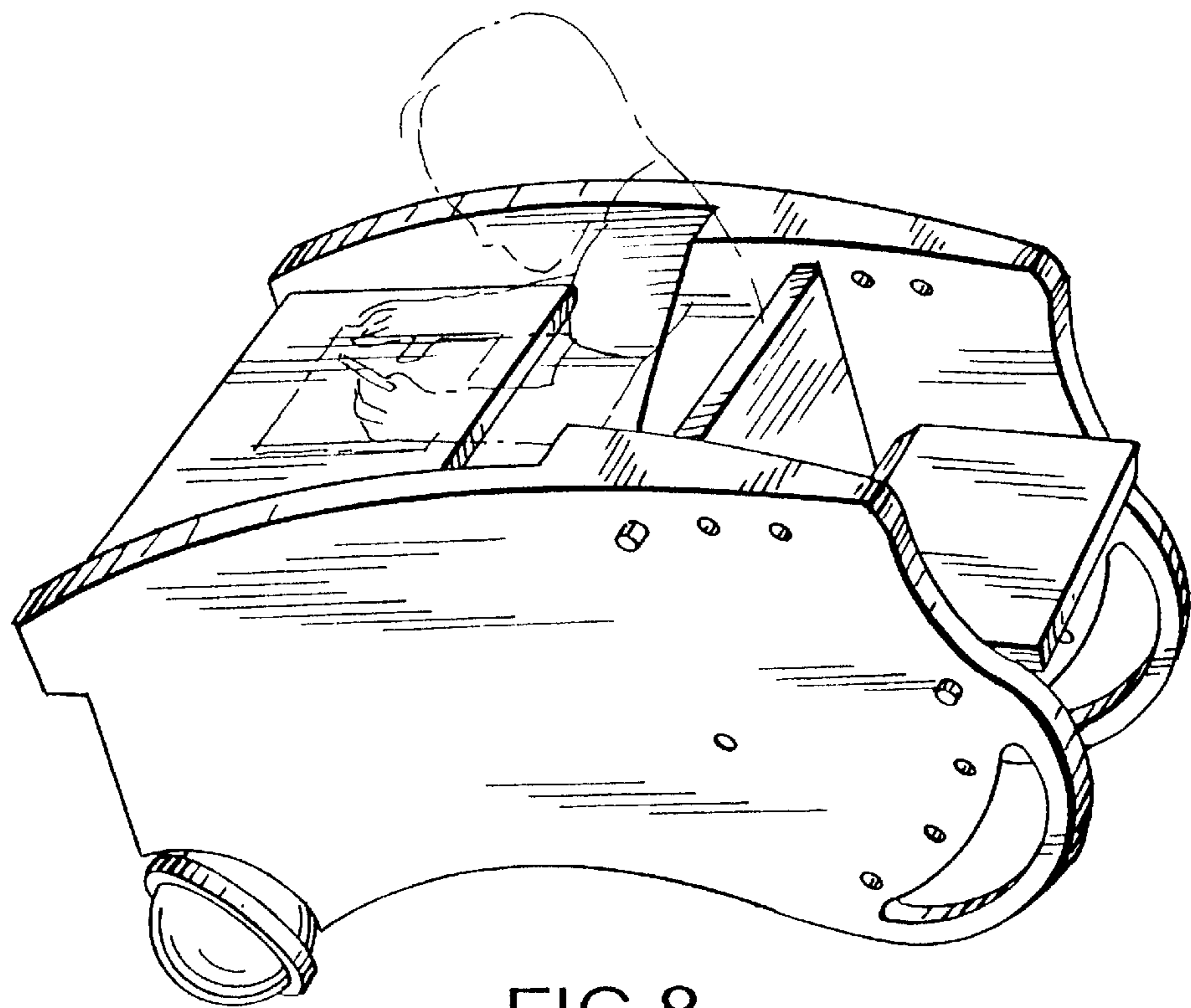

FIG. 8