



US00D408953S

# United States Patent [19] Golichowski et al.

[11] **Patent Number: Des. 408,953**

[45] **Date of Patent: \*\*Apr. 27, 1999**

[54] **FOOD SERVICE STORAGE CART**

5,282,678 2/1994 Teufel et al. .... 312/221  
5,566,961 10/1996 Snell et al. .... 280/47.35

[75] Inventors: **Gary D. Golichowski**, Inwood, W. Va.;  
**William A. La Follette, Jr.**; **Donald C. Presnell**, both of Stephens City, Va.

### OTHER PUBLICATIONS

Lakeside Manufacturing, Inc. Catalog, pp. 5, 8 and 9 (1996).  
Rubbermaid Commercial Products, Inc. Products Catalog, p. 3 (1996).  
Edward Don & Company Catalog, cover and p. 375 (1996).  
Hubert Catalog, p. 519 (1995).  
C.R. Daniels, Inc. Catalog, 2 pages (undated).

[73] Assignee: **Rubbermaid Commercial Products Inc.**, Winchester, Va.

[\*\*] Term: **14 Years**

*Primary Examiner*—Kay H. Chin  
*Attorney, Agent, or Firm*—Renner, Kenner, Greive, Bobak, Taylor & Weber

[21] Appl. No.: **29/088,115**

[22] Filed: **May 15, 1998**

[51] **LOC (6) Cl.** ..... **12-02**

[52] **U.S. Cl.** ..... **D34/21; D34/19**

[58] **Field of Search** ..... D34/12-27; 280/47.34,  
280/47.35, 79.11, 79.3, 79.2; 211/177, 188,  
194; 312/249.1, 249.11, 308

### [57] CLAIM

The ornamental design for a food service storage cart, as shown and described.

### [56] References Cited

#### U.S. PATENT DOCUMENTS

Re. 34,171	2/1993	Romick et al.	312/257.1
D. 286,819	11/1986	Cohn	D34/19
D. 322,875	12/1991	Kelley	D34/21
D. 323,915	2/1992	Welch	D34/21
D. 325,800	4/1992	Kelley	D34/19
D. 349,383	8/1994	McCaffrey	D34/19
D. 353,927	12/1994	Maddux	D34/21
D. 362,101	9/1995	Maddux et al.	D34/20
D. 366,750	1/1996	Daugherty	D34/27
D. 391,032	2/1998	Delmerico	D34/21
3,797,842	3/1974	Swick, Jr. et al.	280/36 R
3,868,123	2/1975	Berg et al.	280/79.2
4,114,965	9/1978	Oye et al.	312/209
4,616,890	10/1986	Romick	312/257 R
4,620,637	11/1986	Karashima	211/188
5,016,948	5/1991	Welch et al.	312/250
5,048,702	9/1991	Maloney	211/194
5,069,511	12/1991	Swets et al.	312/107.5
5,259,668	11/1993	Teufel et al.	312/249.11
5,281,020	1/1994	Romick	312/308

### DESCRIPTION

FIG. 1 is a front, top, left side perspective view of a food service storage cart showing our new design;  
FIG. 2 is a rear elevational view thereof;  
FIG. 3 is a right side elevational view thereof, the left side being identical;  
FIG. 4 is a front elevational view thereof;  
FIG. 5 is a top plan view thereof; and,  
FIG. 6 is a bottom plan view thereof;  
FIG. 7 is a front, top, left side perspective view of a second embodiment of the food service storage cart;  
FIG. 8 is a rear elevational view thereof;  
FIG. 9 is a right side elevational view thereof, the left side being identical;  
FIG. 10 is a front elevational view thereof; and,  
FIG. 11 is a top plan view thereof; and,  
FIG. 12 is a bottom plan view thereof.  
The wheels of the food service storage cart have been shown in phantom and play no part in the subject design.

**1 Claim, 9 Drawing Sheets**

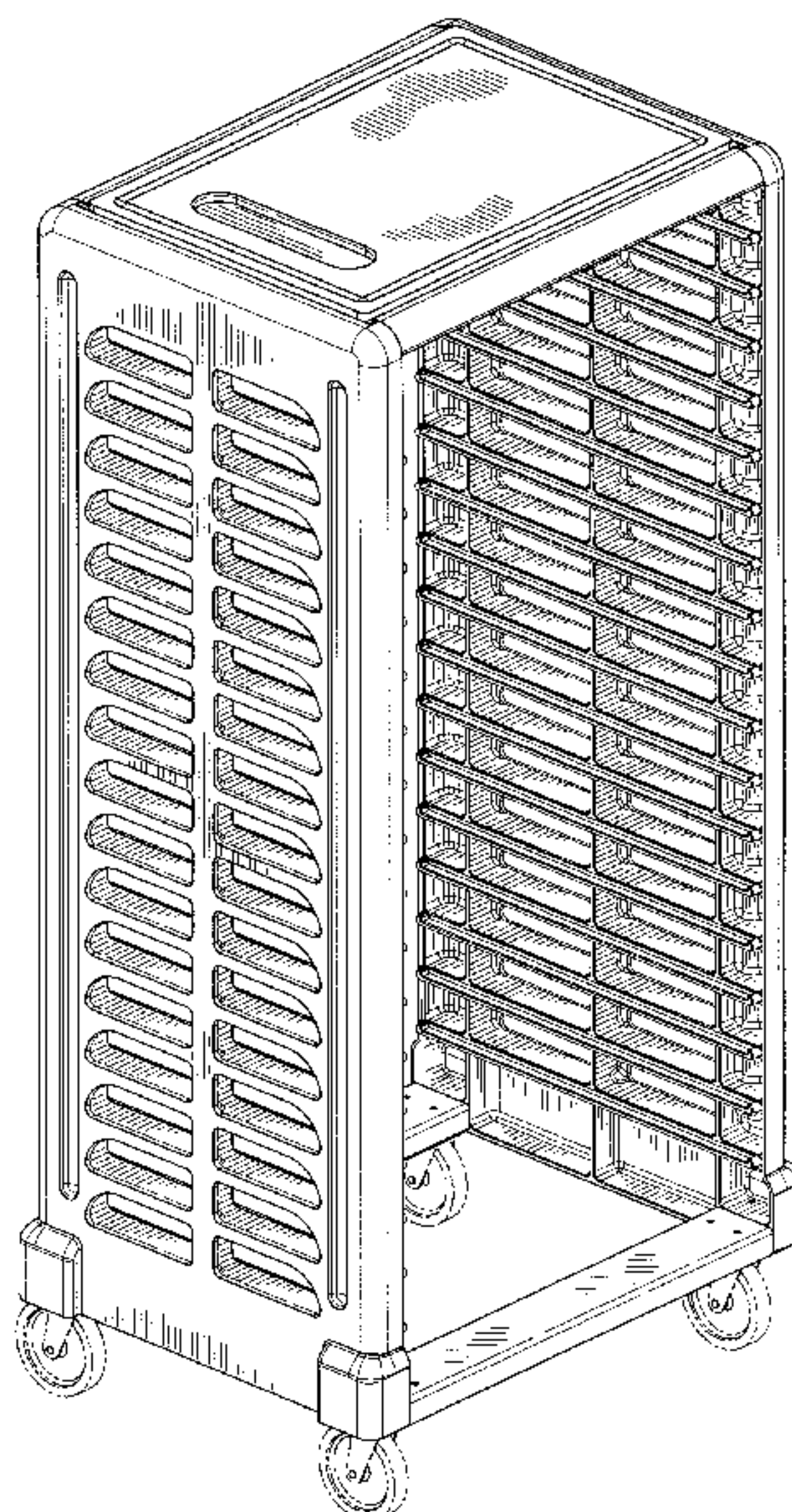



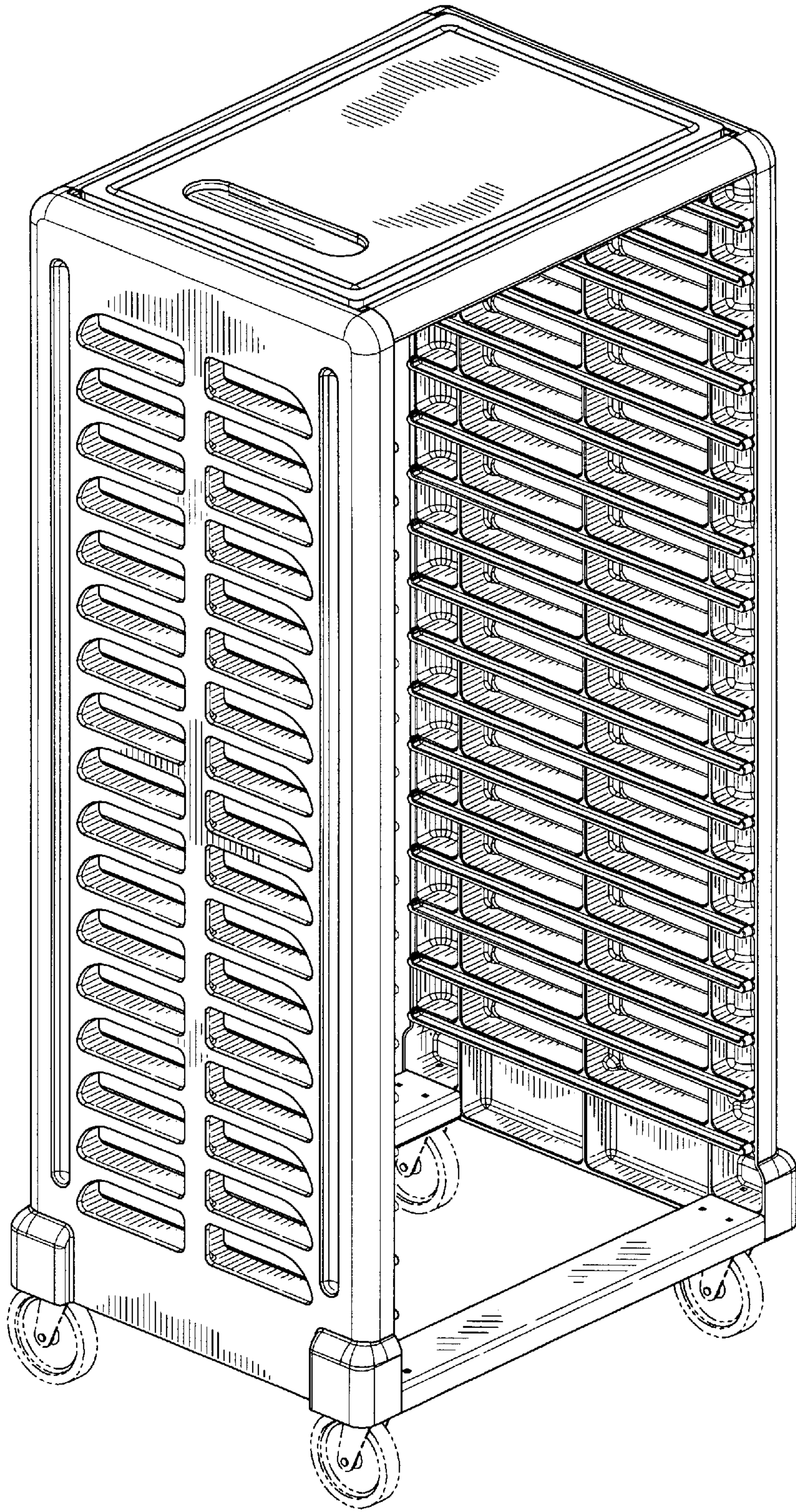

FIG-1

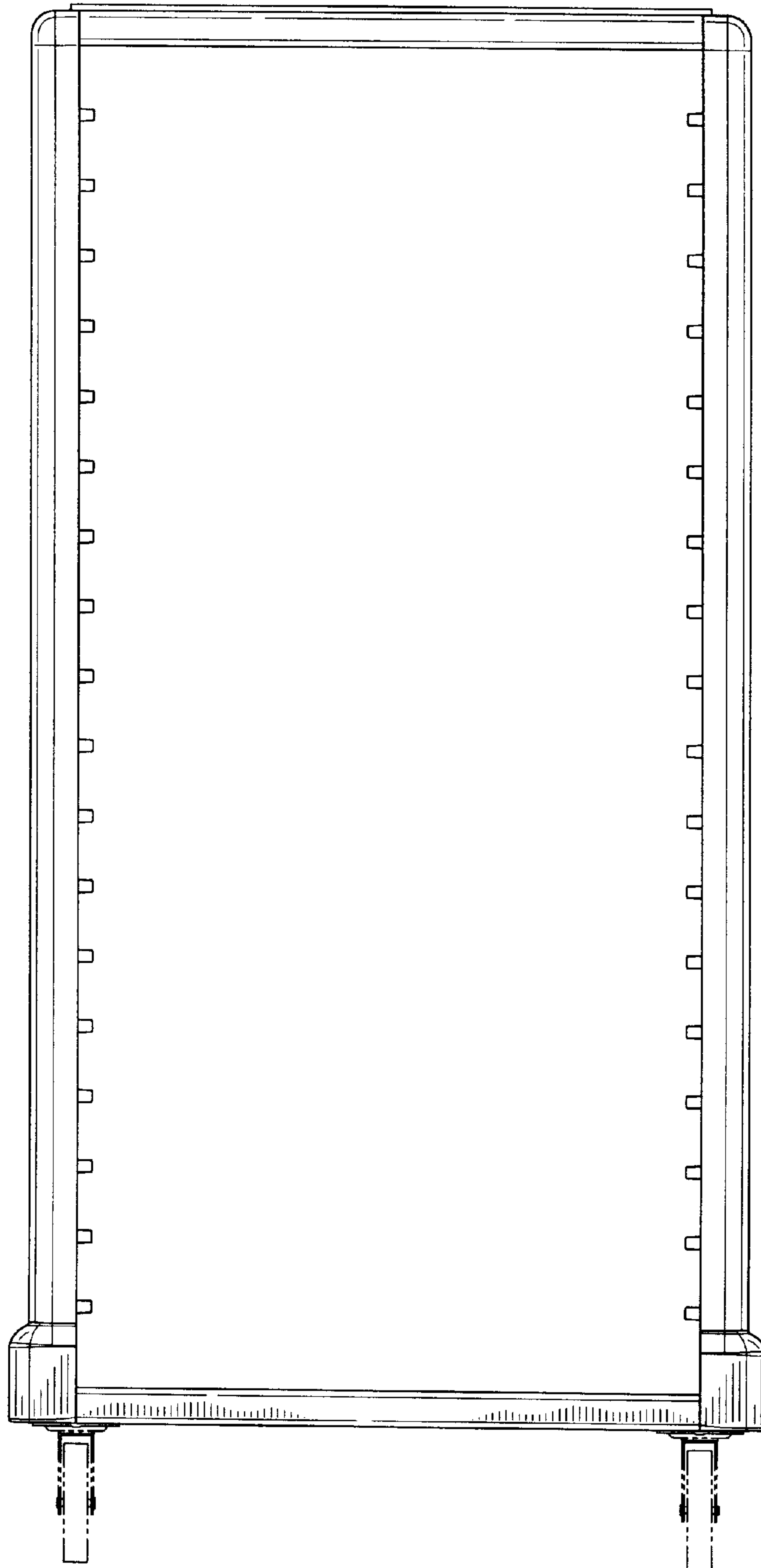

FIG-2

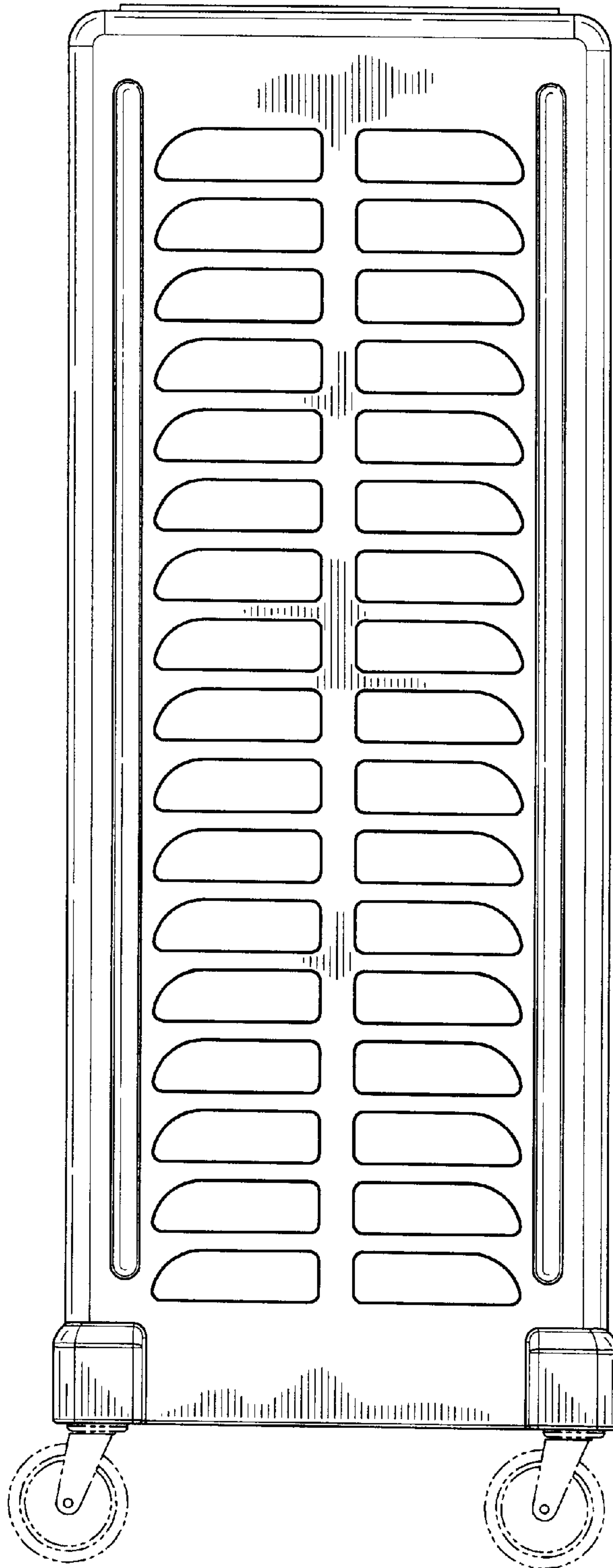

FIG-3

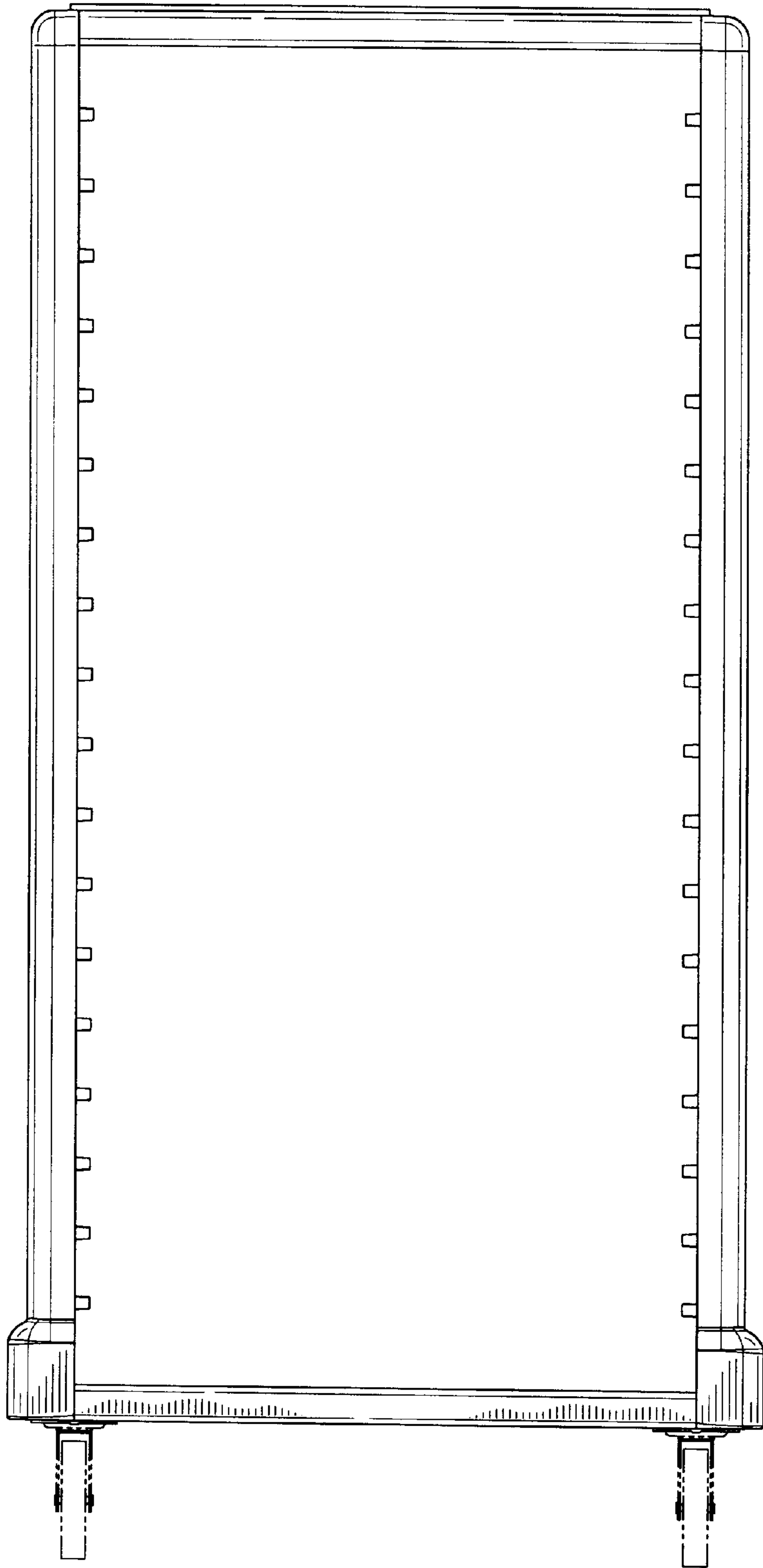

FIG-4



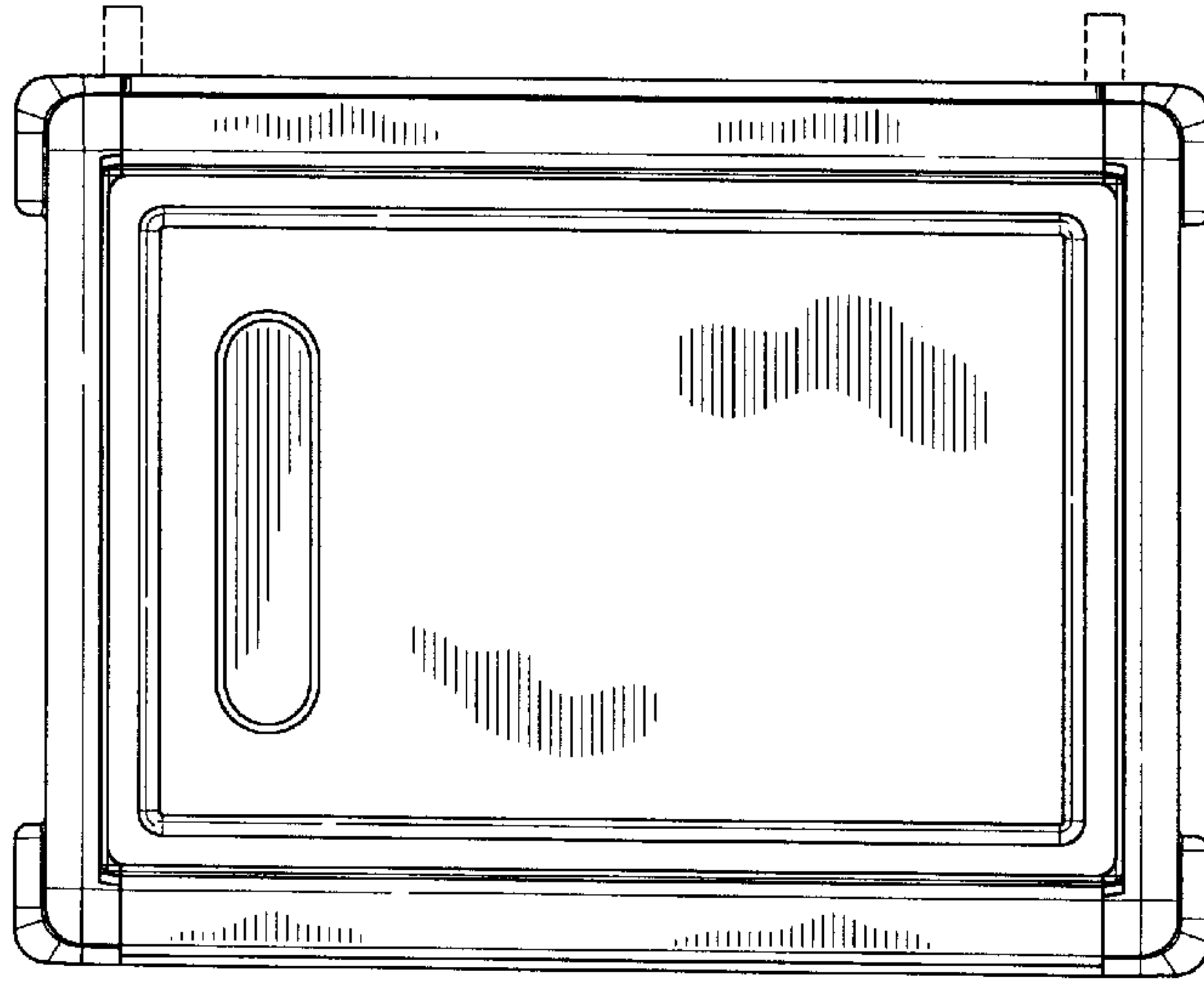

FIG-5

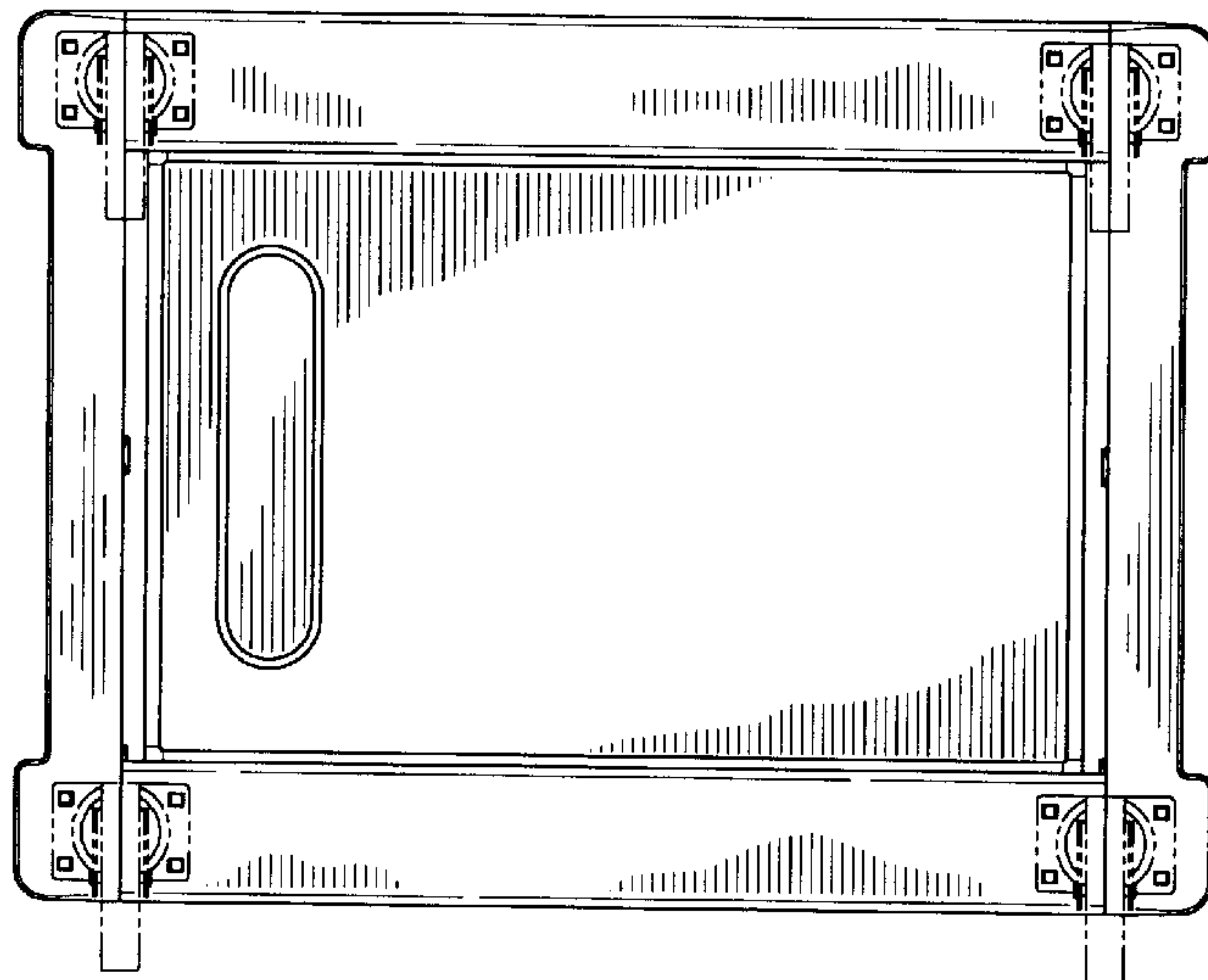

FIG-6

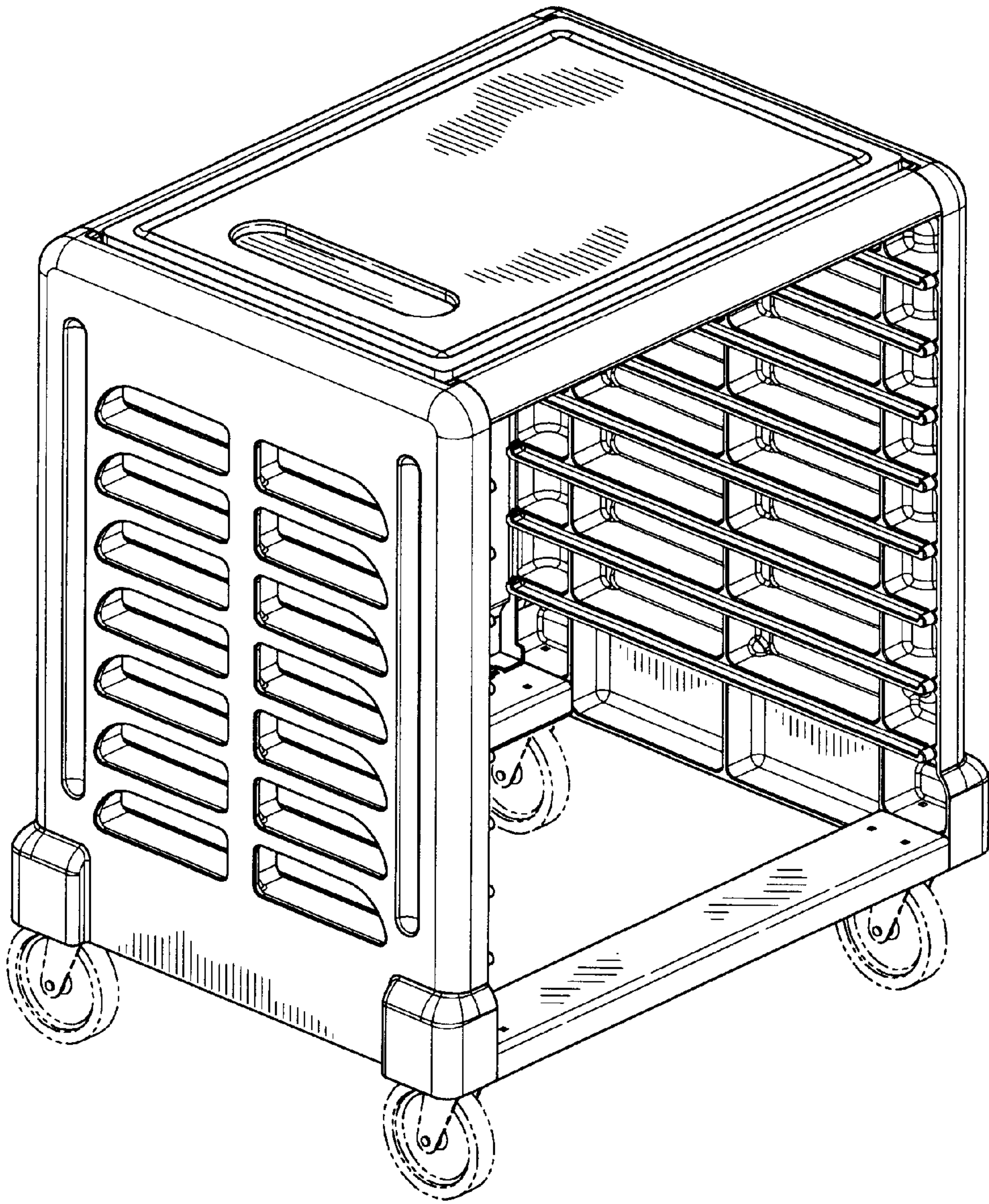

FIG-7

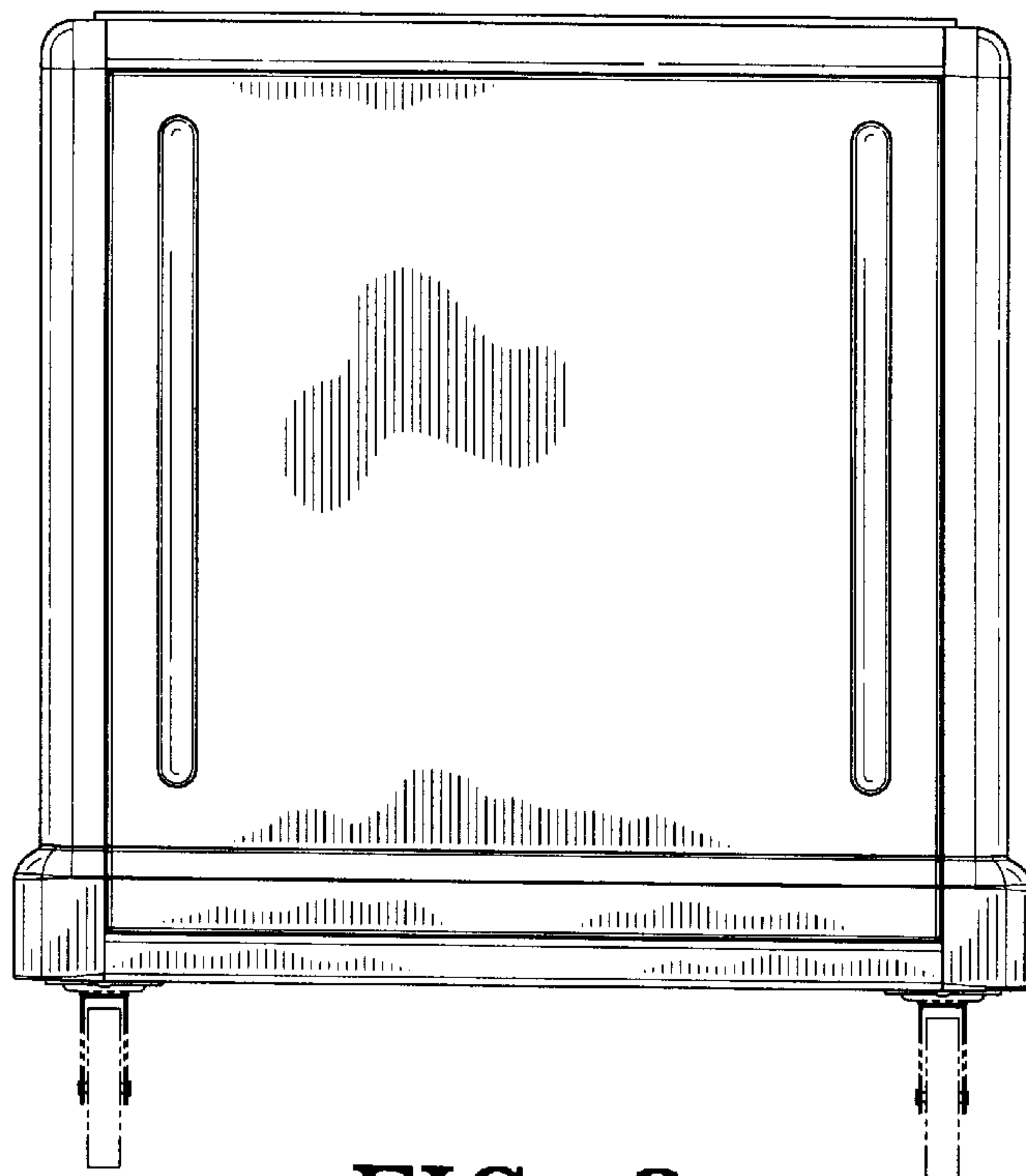

FIG-8

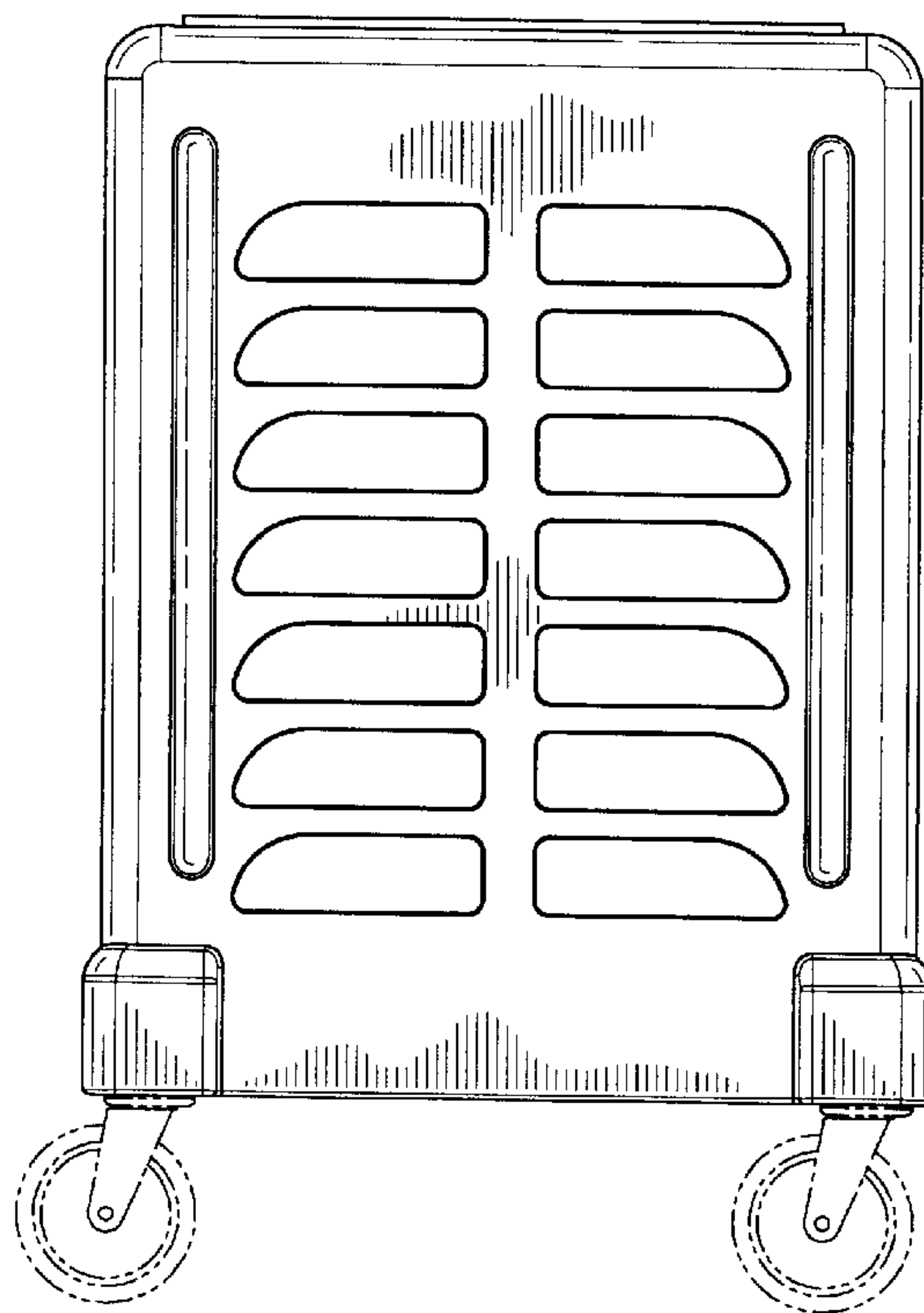

FIG-9



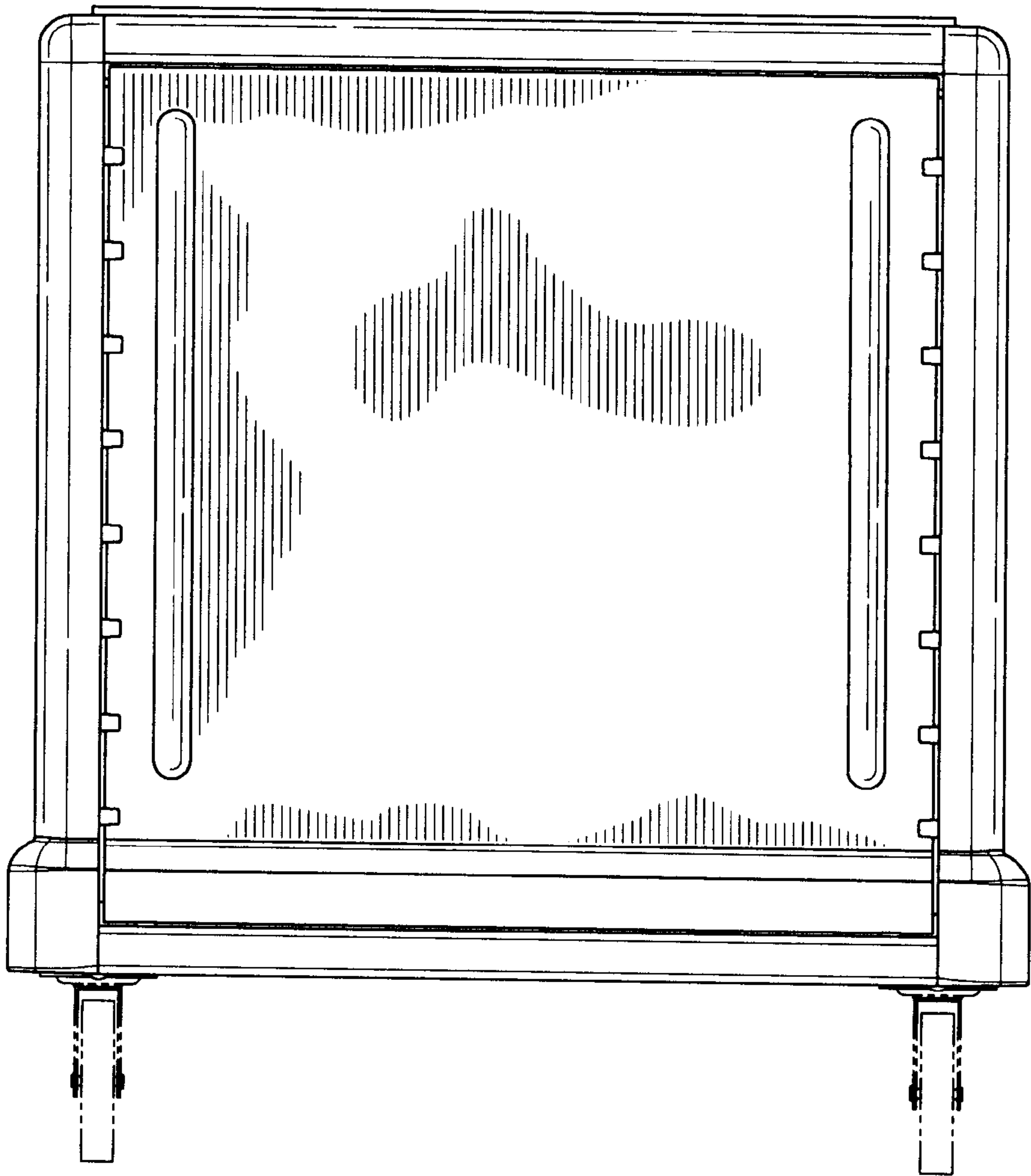

FIG-10

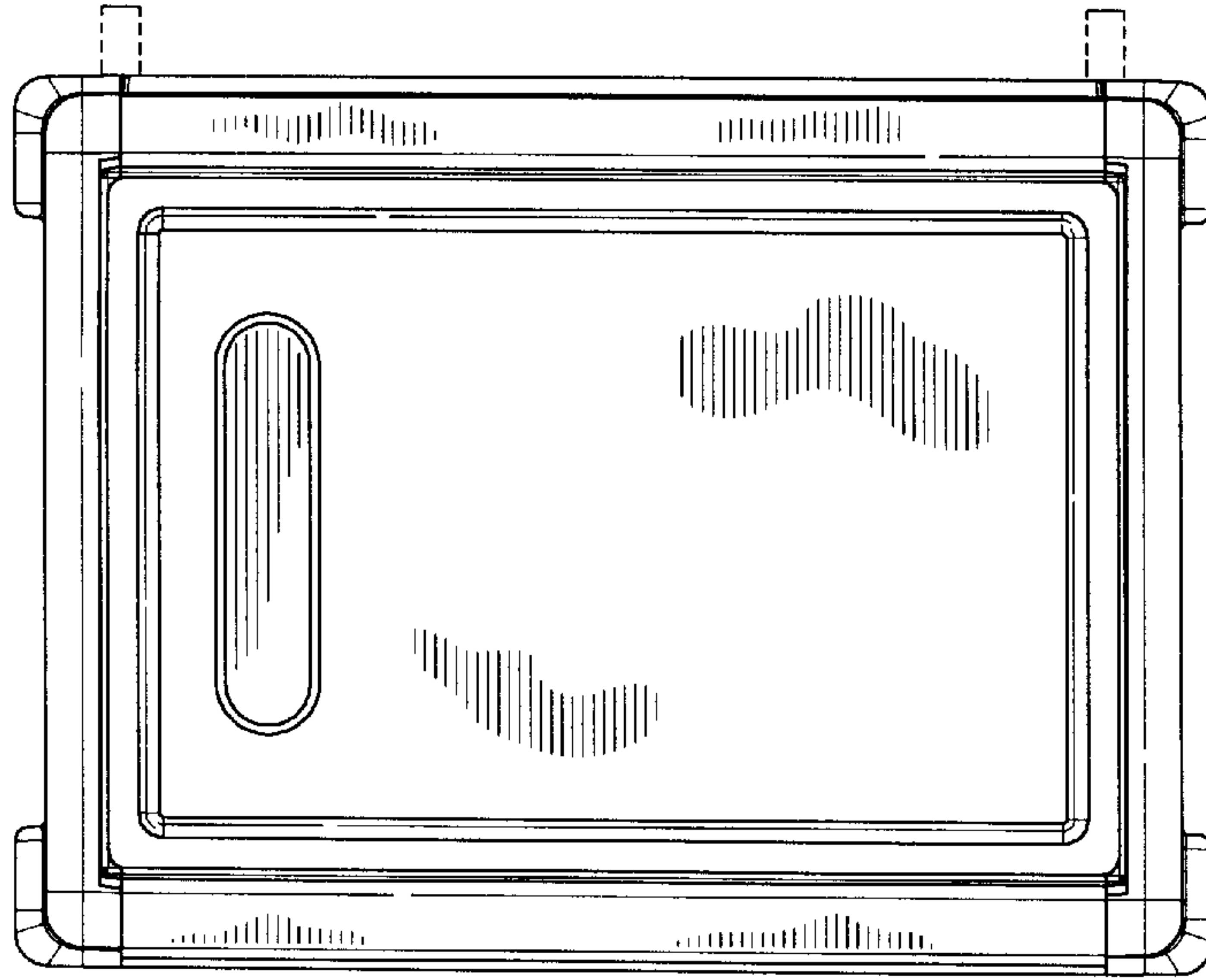

FIG-11

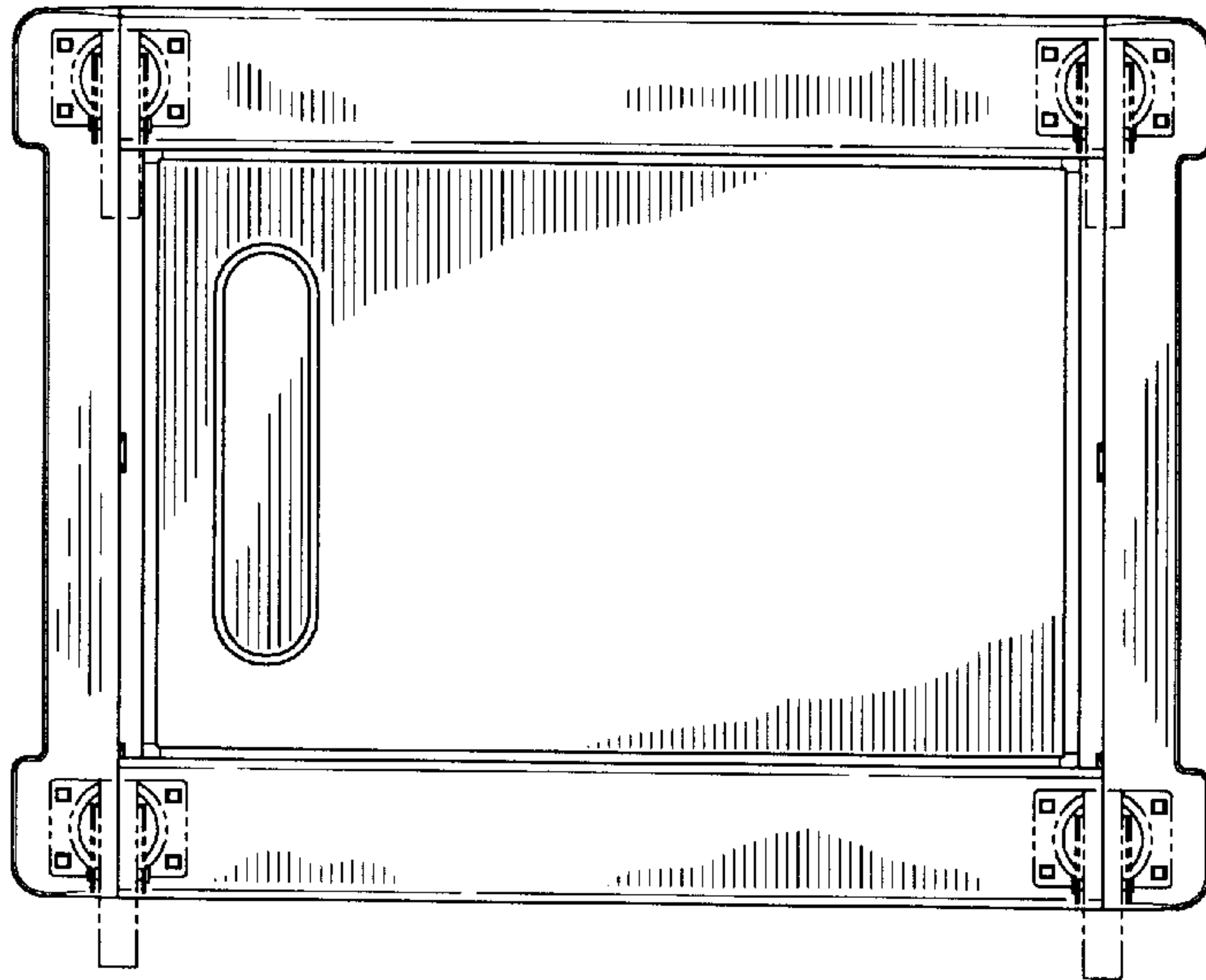

FIG-12