

US00D408952S

United States Patent [19]

Page

[11] **Patent Number: Des. 408,952**

[45] **Date of Patent: **Apr. 27, 1999**

[54] **WHEELED BOOK CARRIER**

[76] Inventor: **Curtis Page**, 705 Deerfield St., Ontario, Calif. 91761

[**] Term: **14 Years**

[21] Appl. No.: **29/086,973**

[22] Filed: **Apr. 23, 1998**

[51] **LOC (6) Cl.** **12-02**

[52] **U.S. Cl.** **D34/25; D34/24**

[58] **Field of Search** D34/12-27, 1, D34/5; 280/47.24, 47.26, 47.34, 79.11, 79.2, 47.35, 655

[56] **References Cited**

U.S. PATENT DOCUMENTS

- D. 134,941 2/1943 Hansen D34/25
- D. 383,581 9/1997 Ordonez D34/5

- 4,650,200 3/1987 Berfield et al. 280/47.26
- 5,040,811 8/1991 Busken et al. 280/47.34
- 5,197,754 3/1993 Ward 280/655
- 5,201,638 4/1993 Bieri 417/234

Primary Examiner—Kay H. Chin

[57] **CLAIM**

The ornamental design for a wheeled book carrier, as shown.

DESCRIPTION

FIG. 1 is a front elevational view of the wheeled book carrier showing my new design;
 FIG. 2 is a back elevational view thereof;
 FIG. 3 is a left side elevational view thereof;
 FIG. 4 is a right side elevational view thereof;
 FIG. 5 is a top plan view thereof; and,
 FIG. 6 is a bottom plan view thereof.

1 Claim, 3 Drawing Sheets

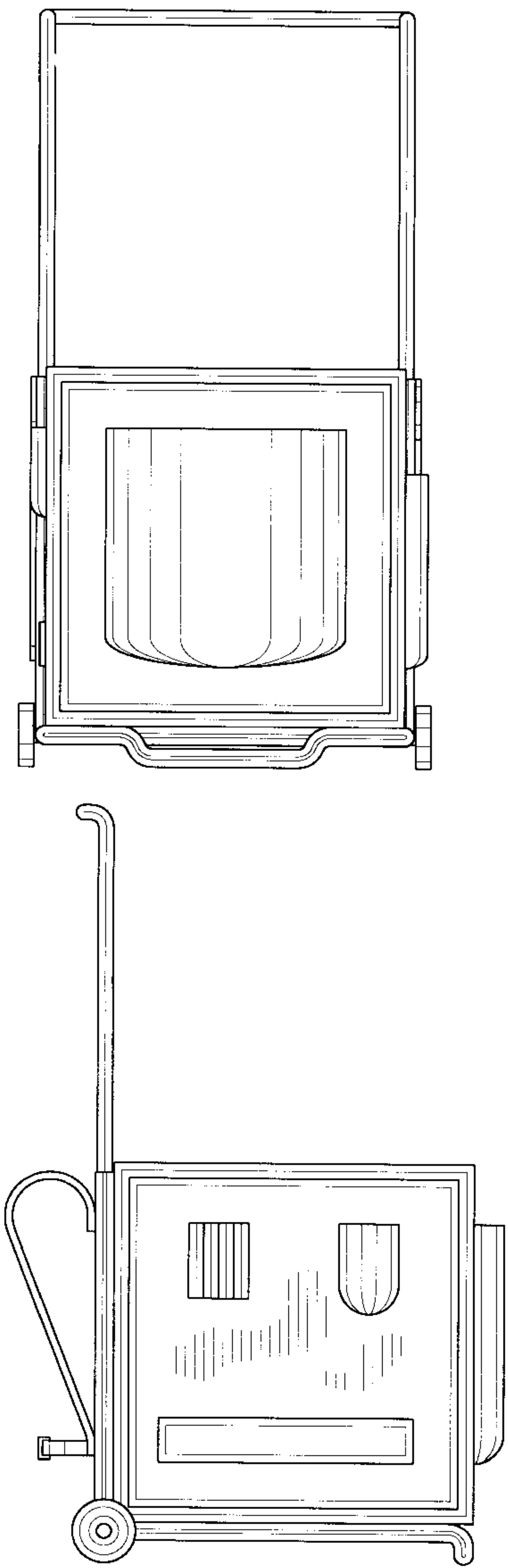

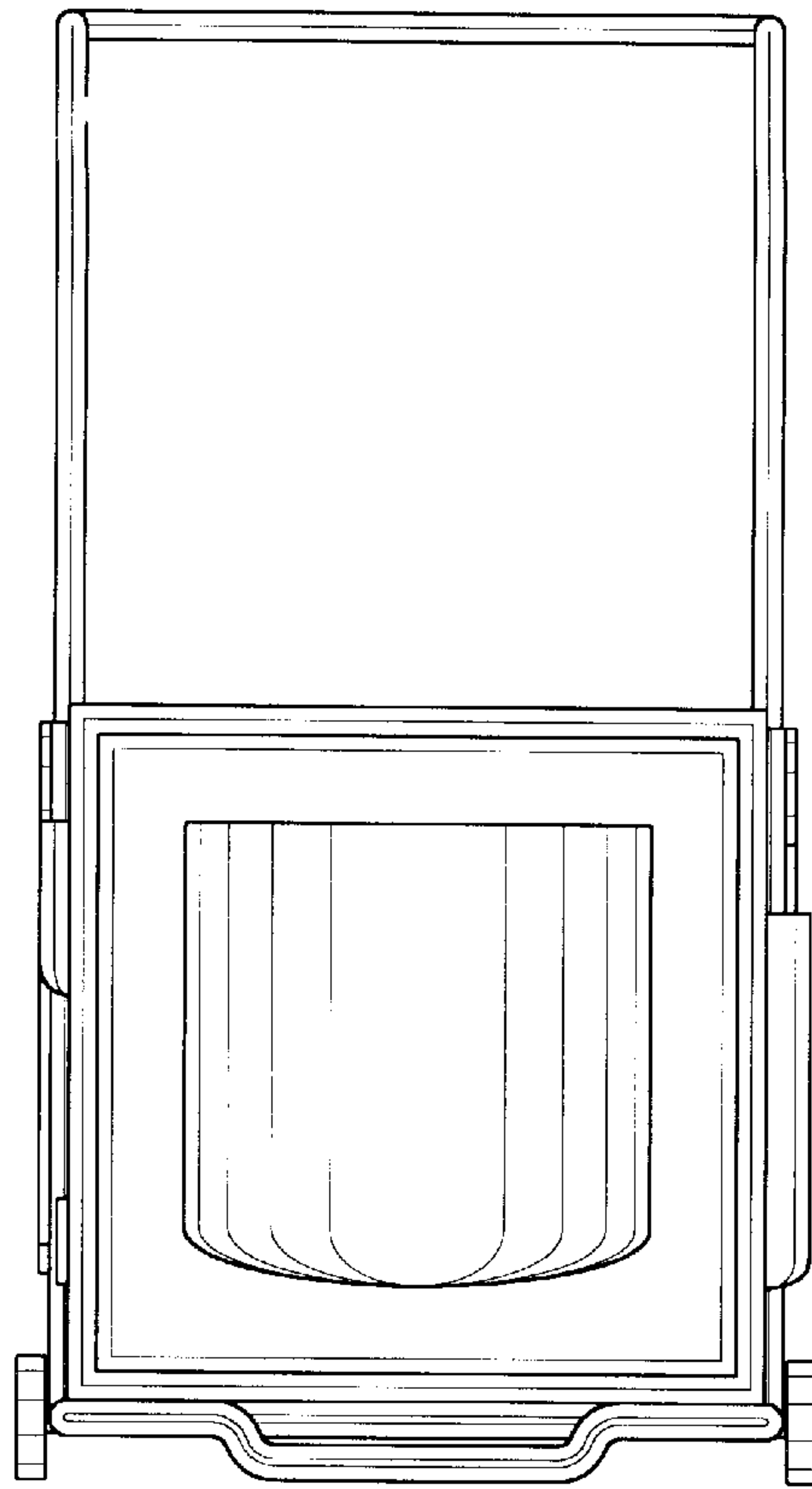

Fig. 1

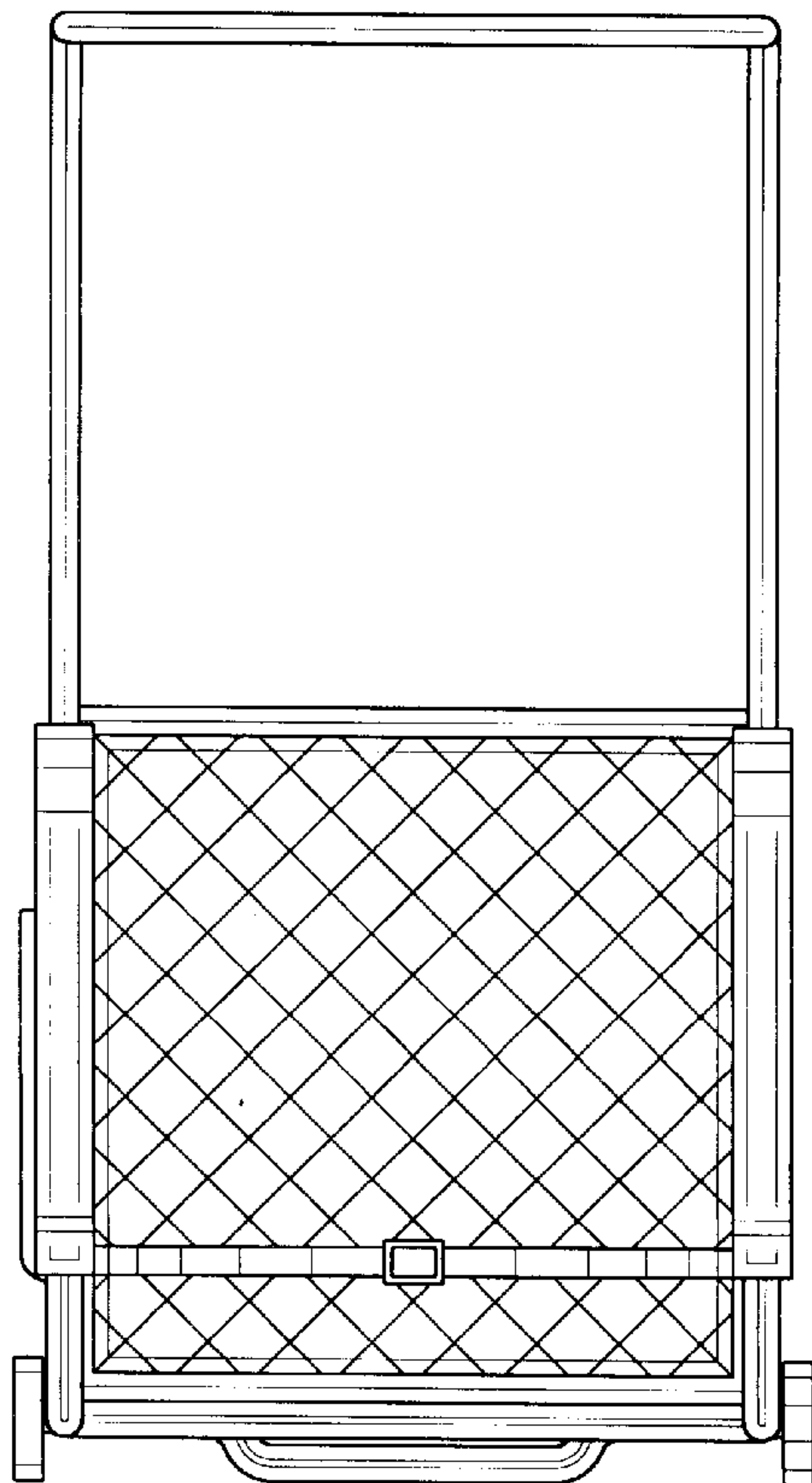

Fig. 2

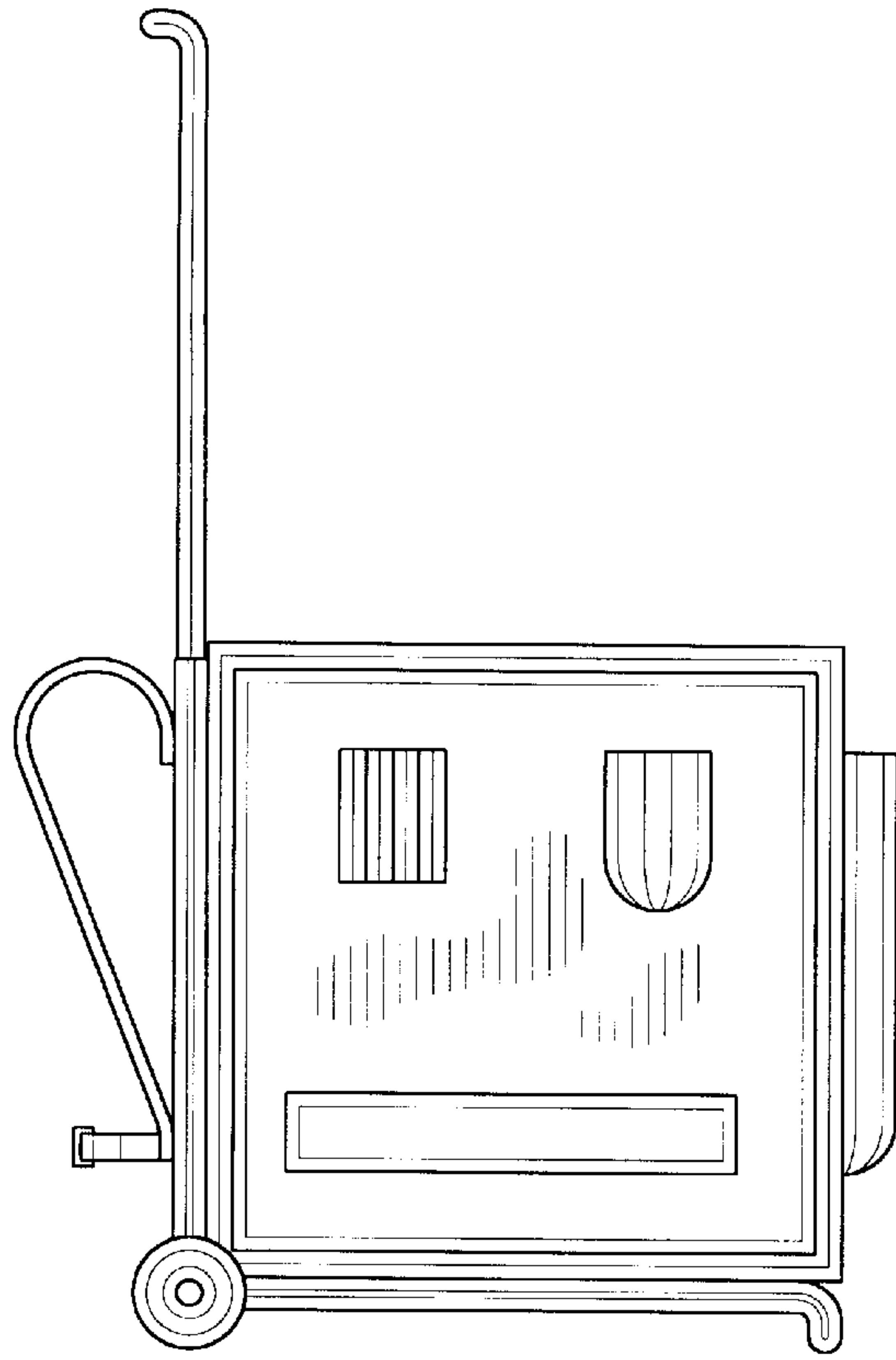

Fig. 3

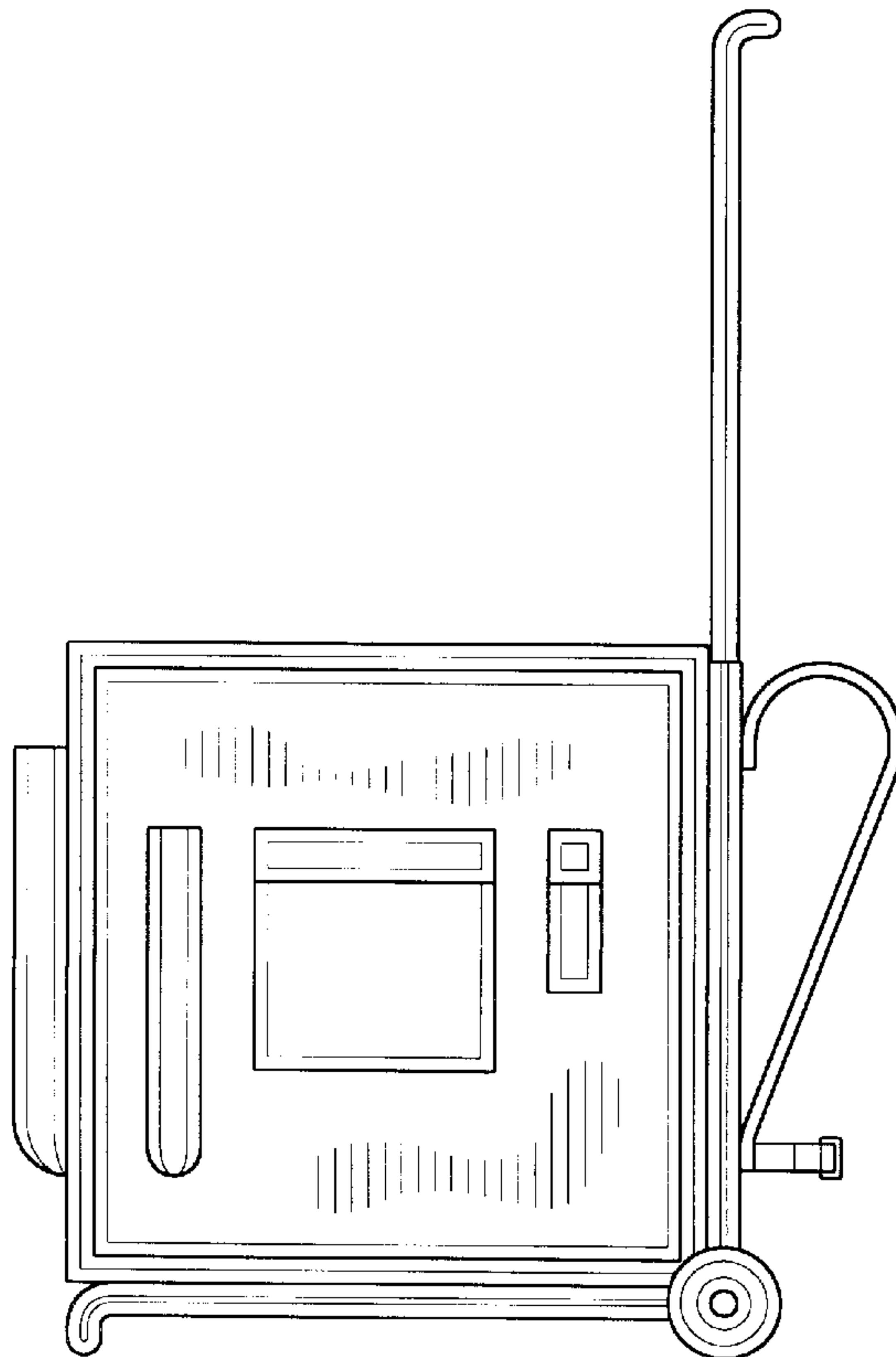

Fig. 4

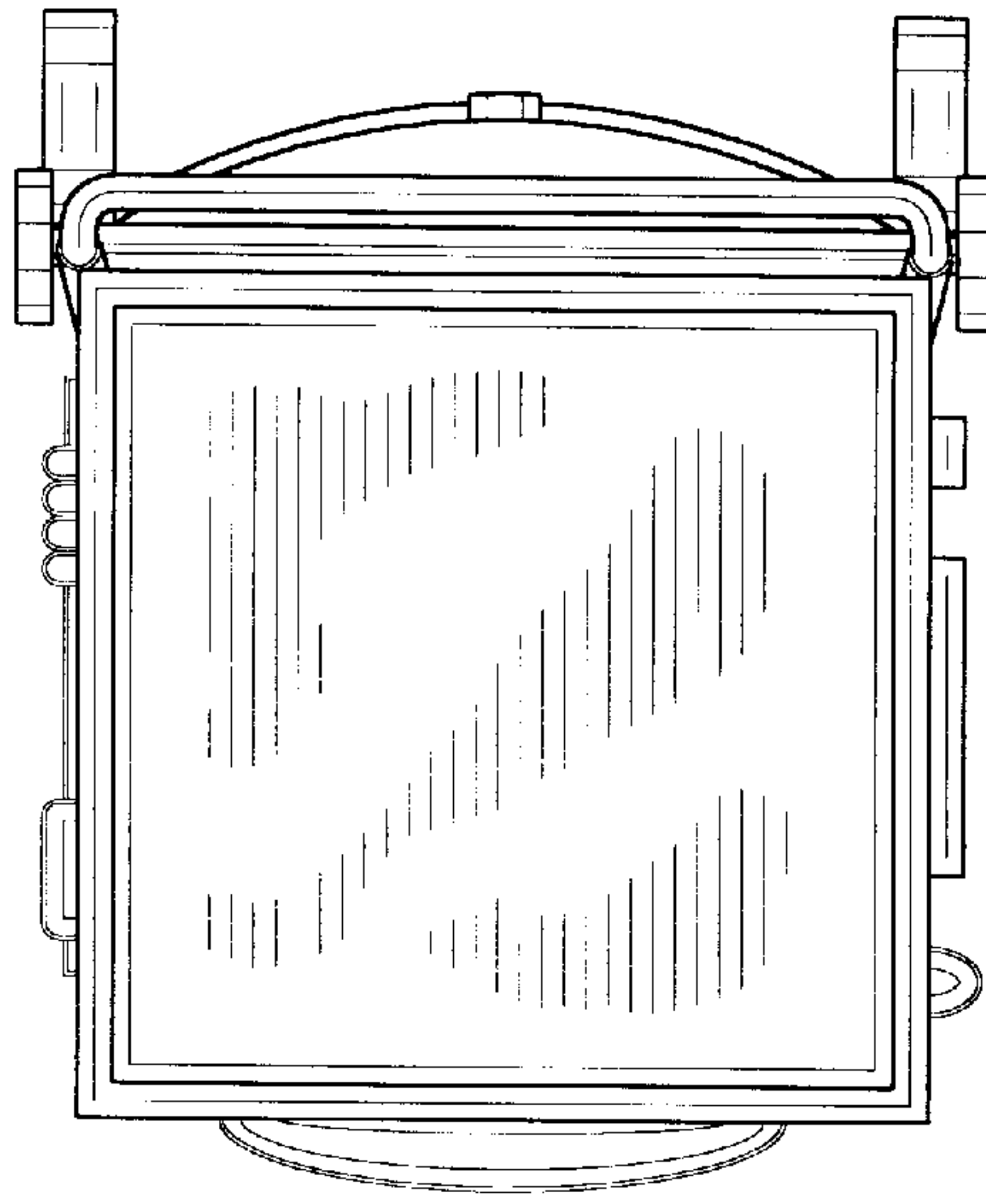

Fig. 5

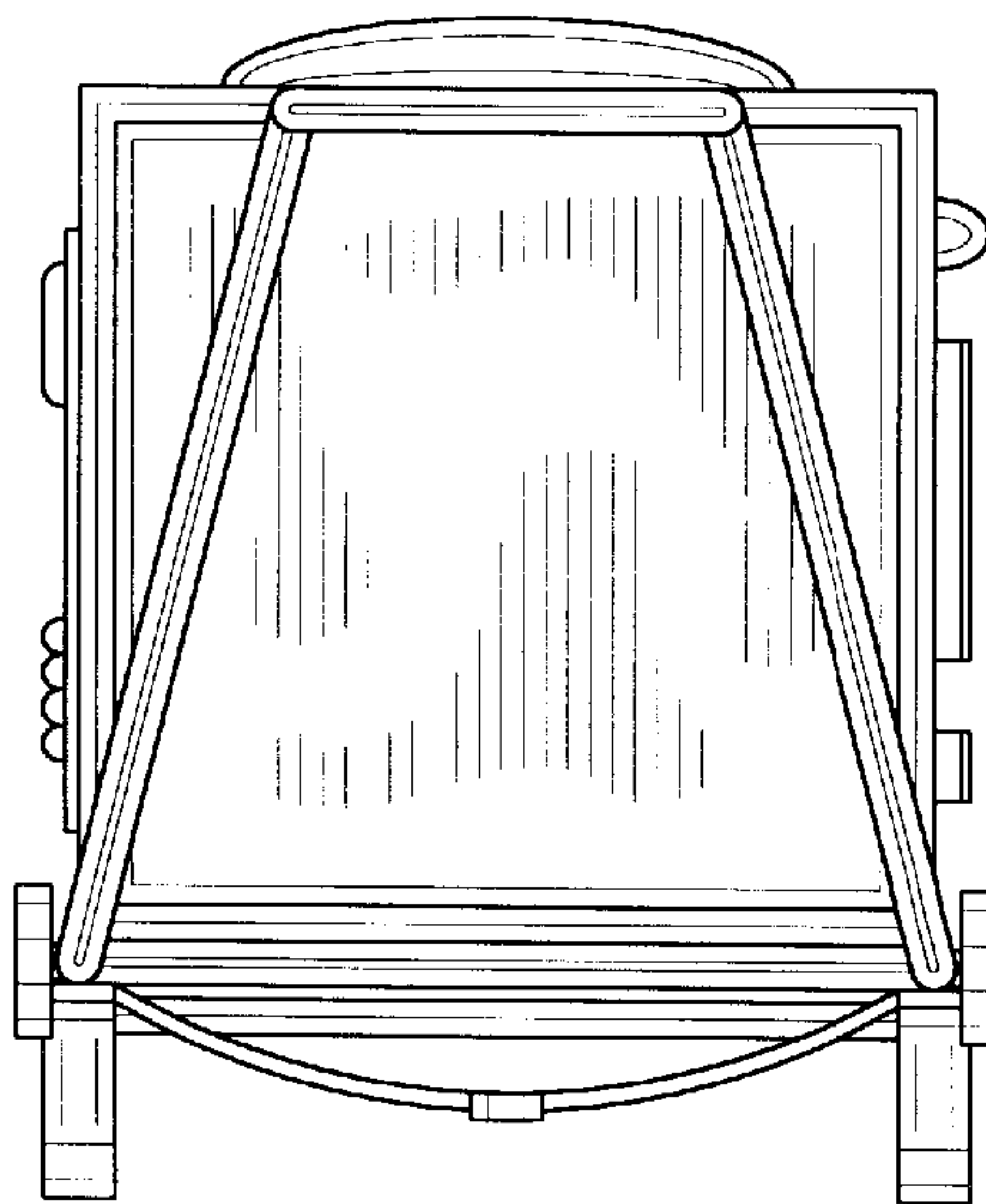

Fig. 6