



US00D408890S

United States Patent [19] Wang

[11] **Patent Number: Des. 408,890**

[45] **Date of Patent: **Apr. 27, 1999**

[54] **WATER SPRAY GUN**

D. 377,966 2/1997 Wang D23/226
D. 390,633 2/1998 Guo D23/226

[75] Inventor: **King-Yuan Wang**, Changhua Hsien, Taiwan

Primary Examiner—Alan P. Douglas
Assistant Examiner—Robin V. Taylor
Attorney, Agent, or Firm—Bacon & Thomas, PLLC

[73] Assignee: **Yuan Mei Corp.**, Changhua Hsien, Taiwan

[57] **CLAIM**

[**] Term: **14 Years**

The ornamental design for water spray gun, as shown and described.

[21] Appl. No.: **29/088,576**

DESCRIPTION

[22] Filed: **May 27, 1998**

FIG. 1 is a perspective view of water spray gun showing my new design;
FIG. 2 is a front view thereof;
FIG. 3 is a rear view thereof;
FIG. 4 is a left side view thereof;
FIG. 5 is a right side view thereof;
FIG. 6 is top view thereof; and,
FIG. 7 is a bottom view thereof.

[51] **LOC (6) Cl.** **23-01**

[52] **U.S. Cl.** **D23/226**

[58] **Field of Search** D23/213, 223,
D23/226; 239/525-528, 394

[56] **References Cited**

U.S. PATENT DOCUMENTS

D. 372,297 7/1996 Wang D23/223

1 Claim, 5 Drawing Sheets

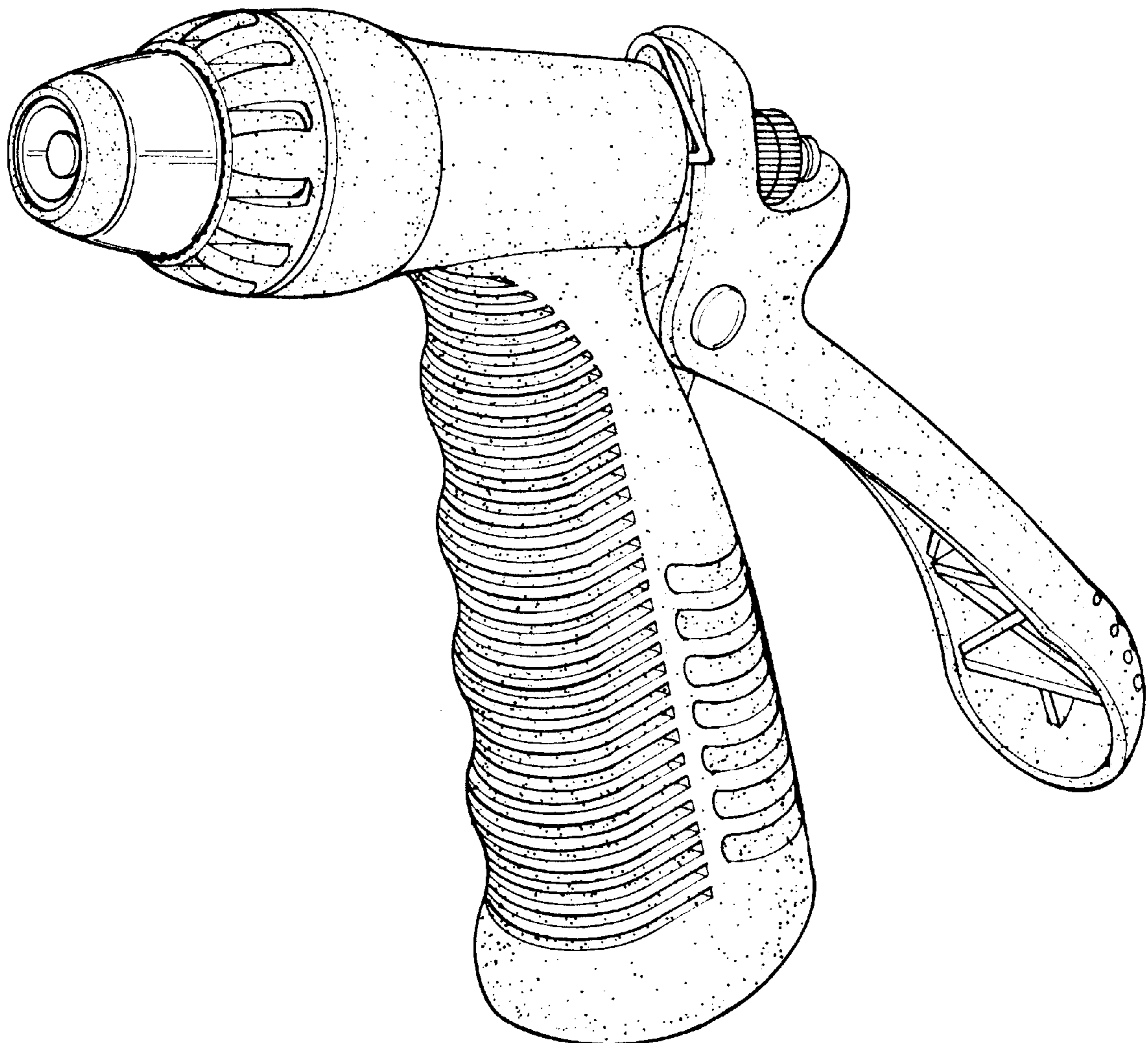

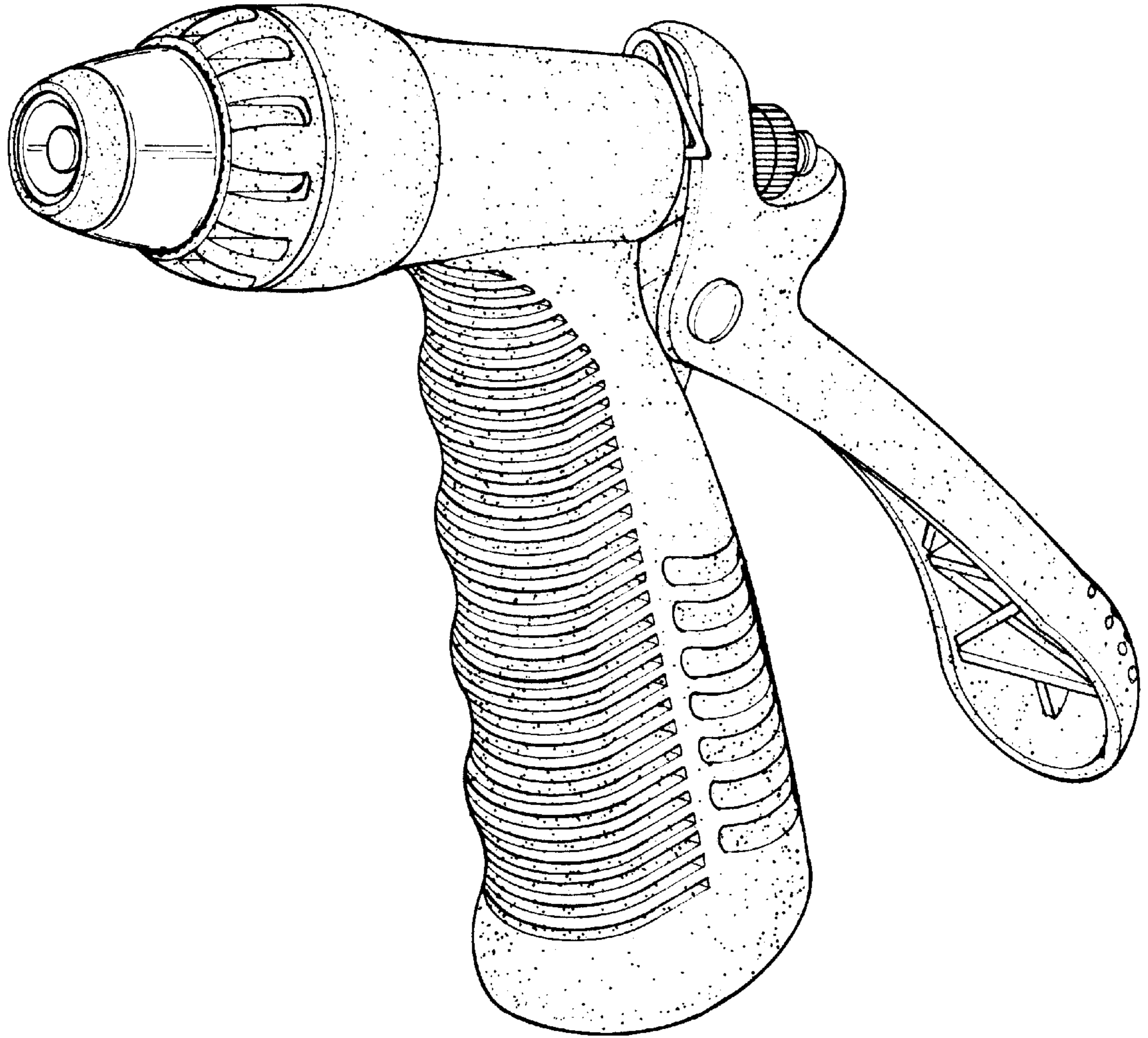

FIG. 1

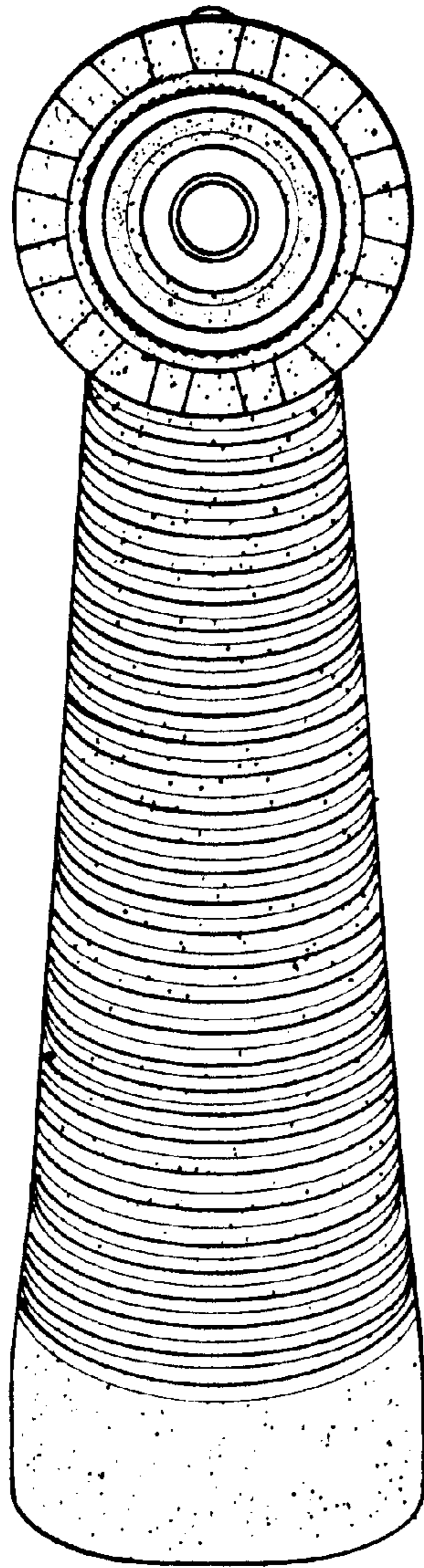

FIG. 2

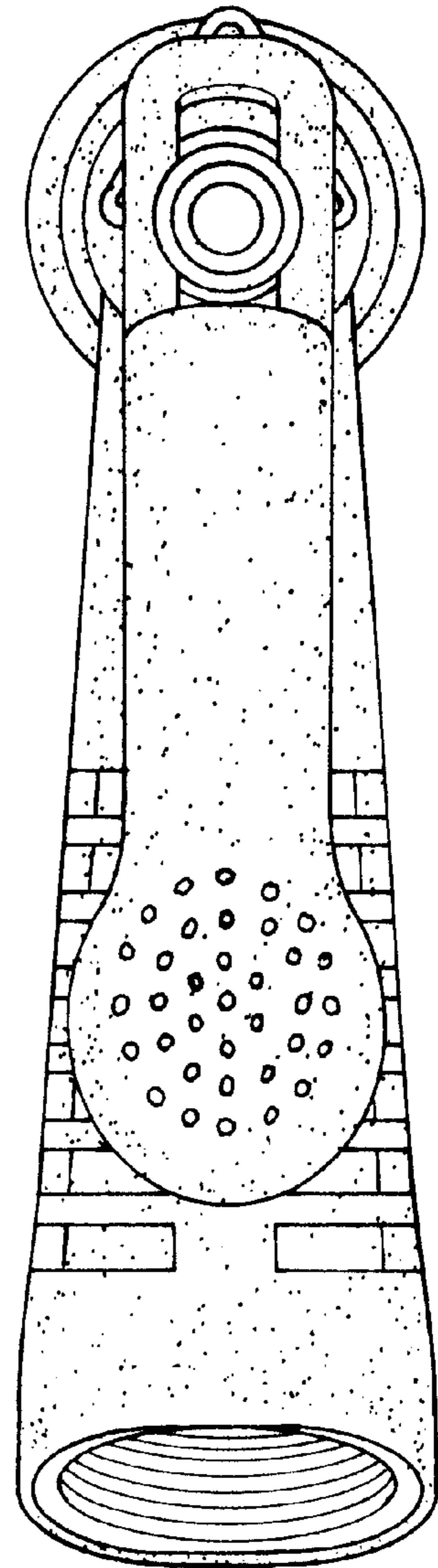

FIG. 3

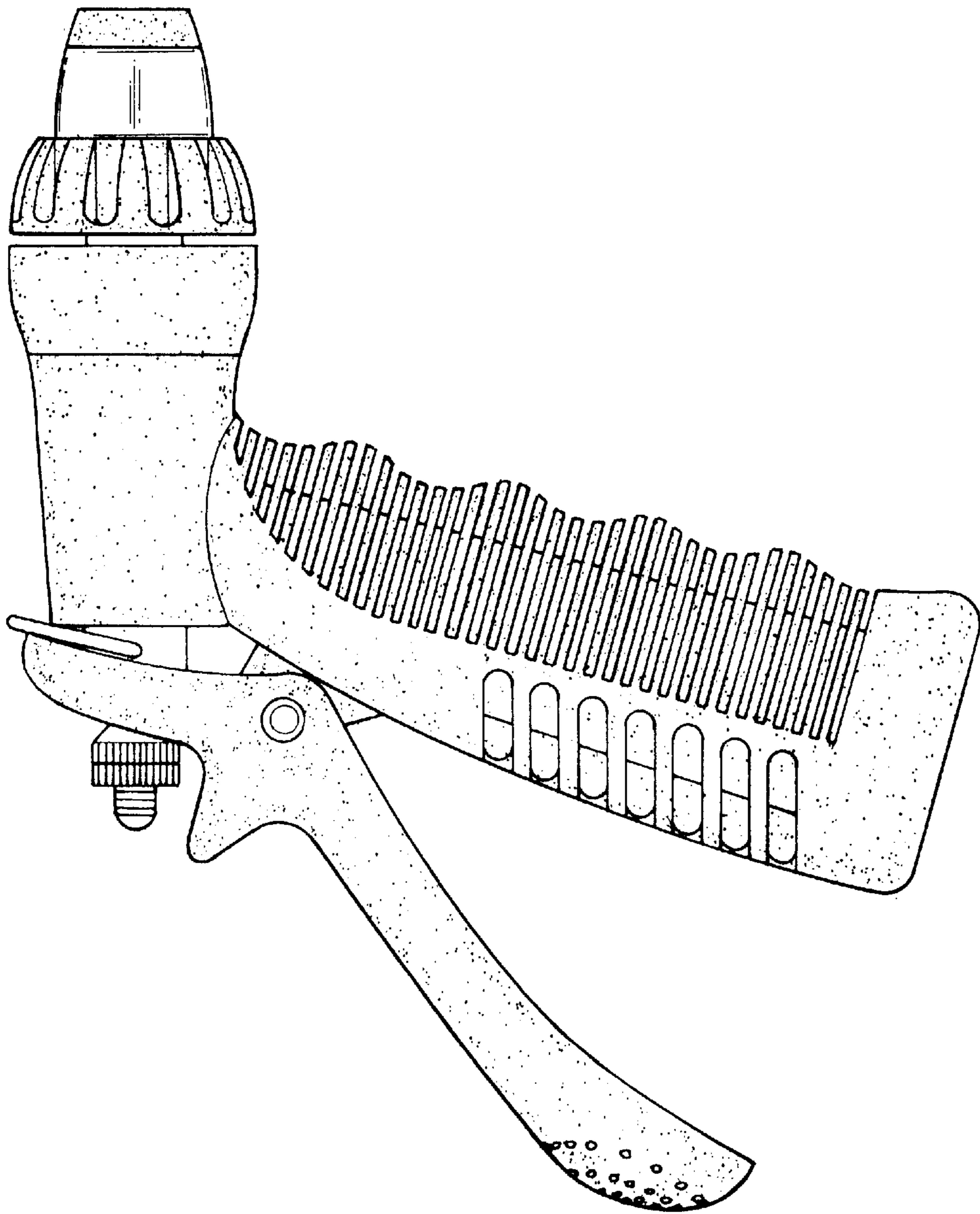

FIG. 4

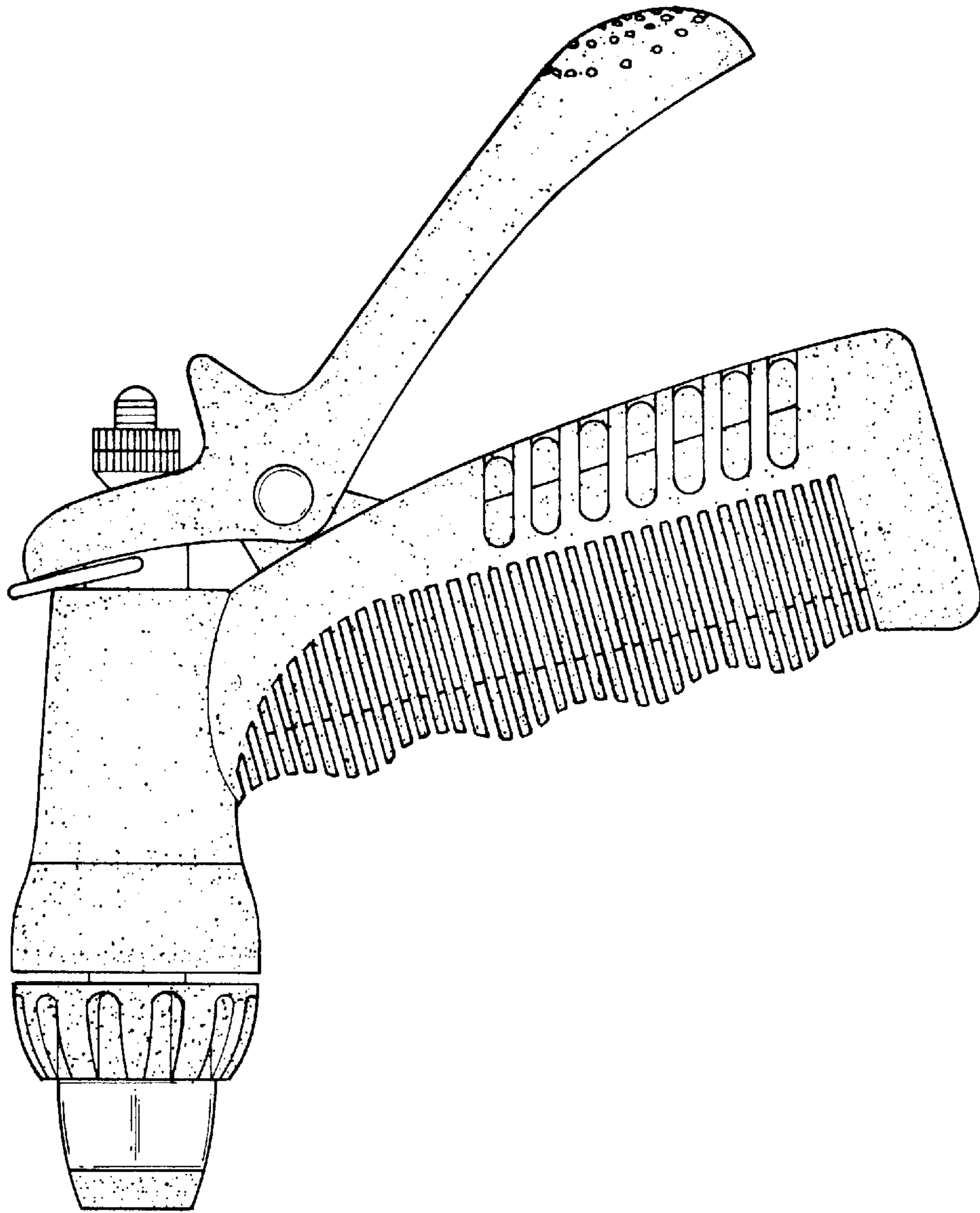

FIG. 5

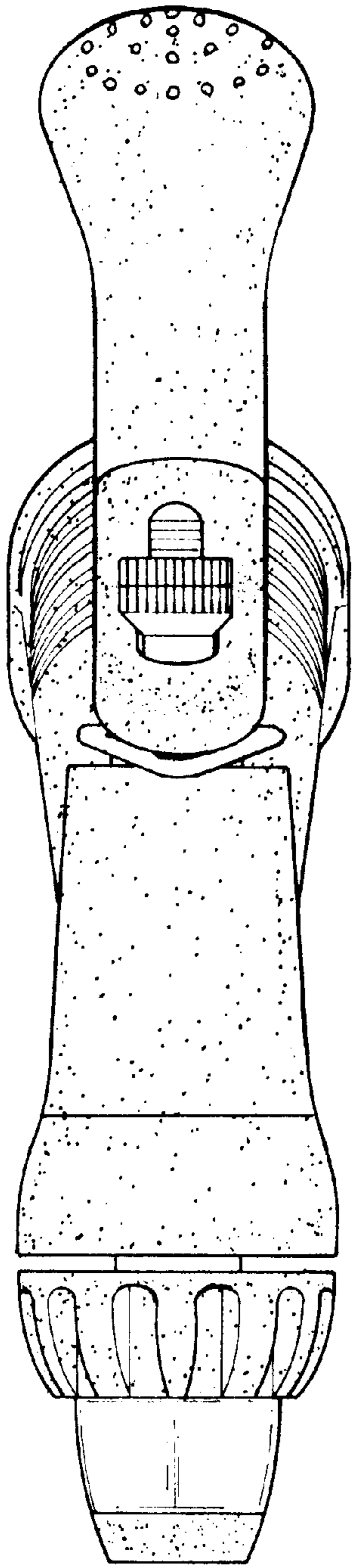

FIG. 6

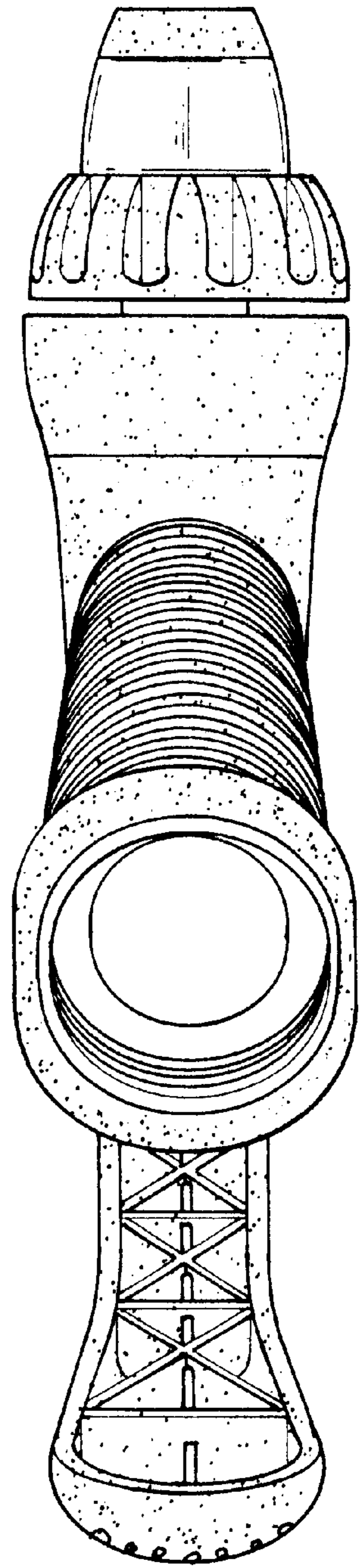

FIG. 7