



US00D408804S

# United States Patent [19]

[11] **Patent Number: Des. 408,804**

**Kurokawa et al.**

[45] **Date of Patent: \*\*Apr. 27, 1999**

[54] **KEYBOARD HOUSING**

*Attorney, Agent, or Firm—Myers Bigel Sibley & Sajovec*

[75] Inventors: **Haruo Kurokawa**, Morrisville;  
**Thomas D. Snyder**, Raleigh, both of  
N.C.

[57] **CLAIM**

The ornamental design for a keyboard housing, as shown and described.

[73] Assignee: **Ericsson Inc.**, Research Triangle Park,  
N.C.

**DESCRIPTION**

[\*\*] Term: **14 Years**

FIG. 1 is a top view of the keyboard housing showing our design in a closed position;  
FIG. 2 is a side view thereof;  
FIG. 3 is a side view thereof;  
FIG. 4 is a back view thereof;  
FIG. 5 is a front view thereof;  
FIG. 6 is bottom view thereof;  
FIG. 7 is a front perspective view thereof;  
FIG. 8 is a top view of the keyboard housing showing our design in a partially open position;  
FIG. 9 is a side view thereof;  
FIG. 10 is a side view thereof;  
FIG. 11 is a back view thereof;  
FIG. 12 is a front view thereof;  
FIG. 13 is a bottom view thereof;  
FIG. 14 is a front perspective view thereof; and,  
FIG. 15 is a front perspective view of the keyboard housing showing our design in a fully open position.  
The broken lines shown herein are for illustrative purposes only and form no part of the claimed design.

[21] Appl. No.: **29/076,635**

[22] Filed: **Sep. 15, 1997**

[51] **LOC (6) Cl.** ..... **14-02**

[52] **U.S. Cl.** ..... **D14/115**

[58] **Field of Search** ..... D14/100, 101,  
D14/106, 115; D18/1, 2, 7; 178/17 A, 17 C;  
200/5 A, 5 R, 6 A, 6 R; 235/145 A, 145 R;  
345/160, 167, 168; 341/22, 23; 364/708.1;  
400/484, 485, 486, 488, 489

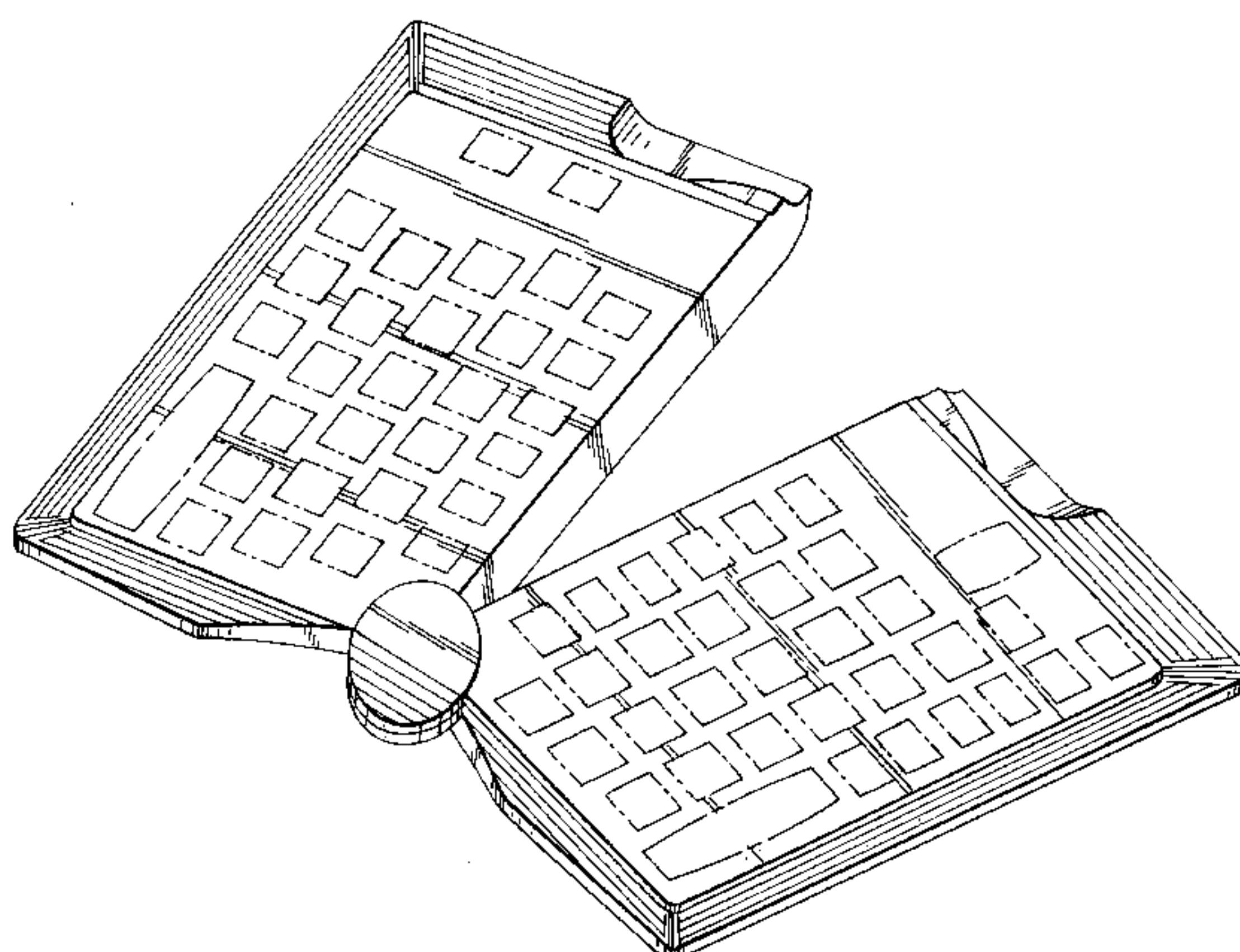
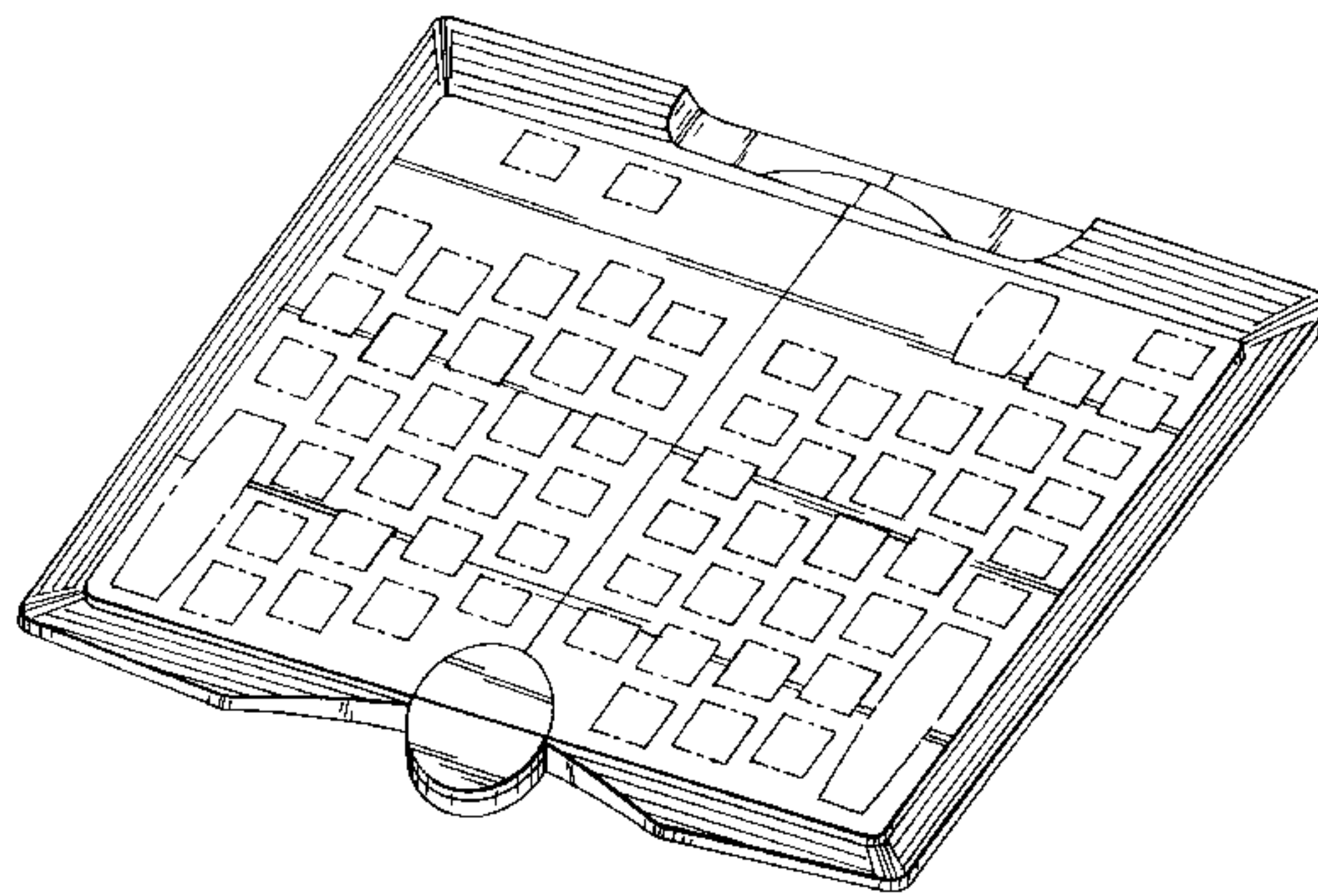
[56] **References Cited**

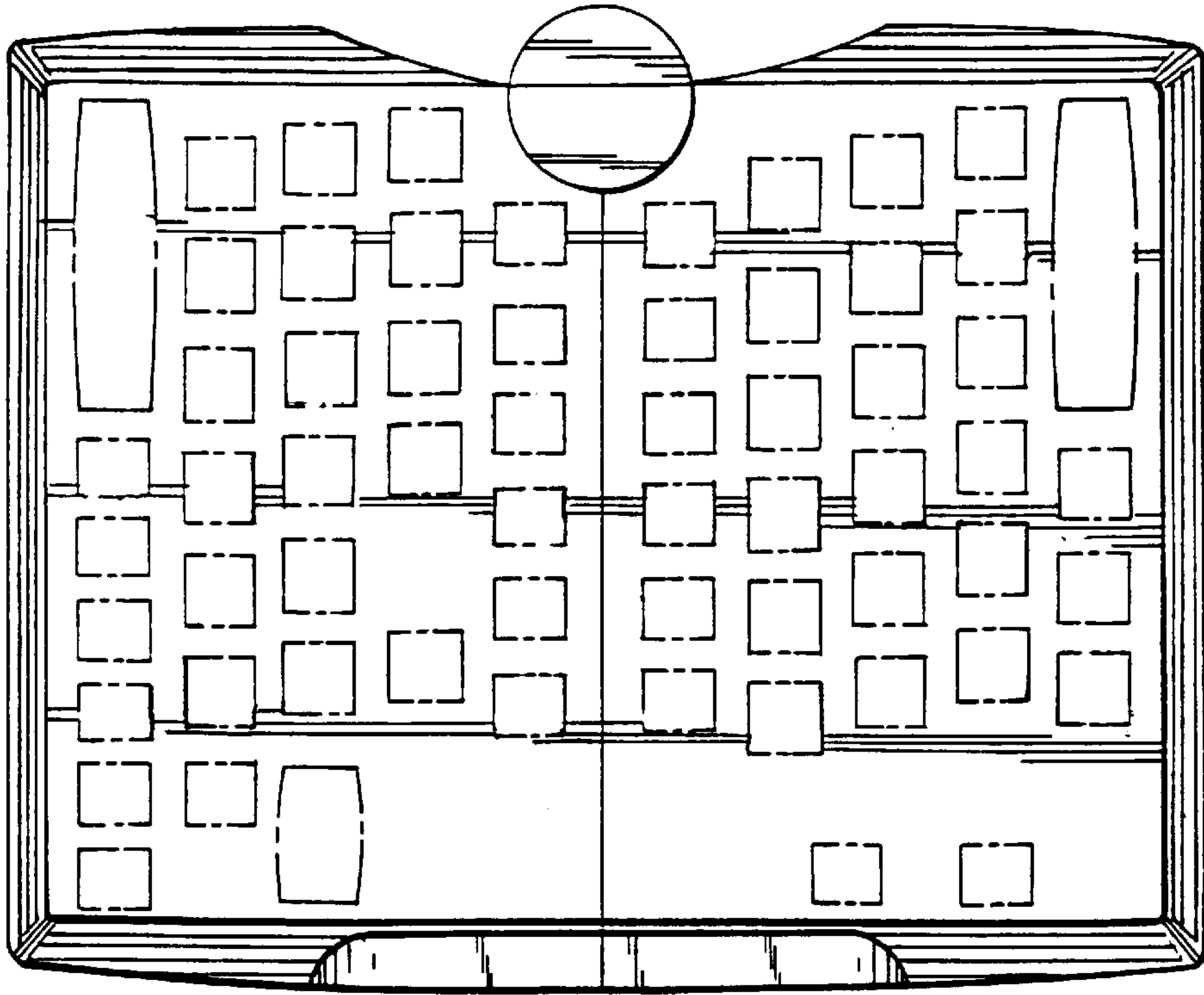
**U.S. PATENT DOCUMENTS**

- D. 347,423 5/1994 Conway ..... D14/115
- D. 362,434 9/1995 Abell, Jr. et al. .... D14/115
- D. 364,155 11/1995 Chung ..... D14/115
- D. 370,476 6/1996 Dalesky ..... D14/115

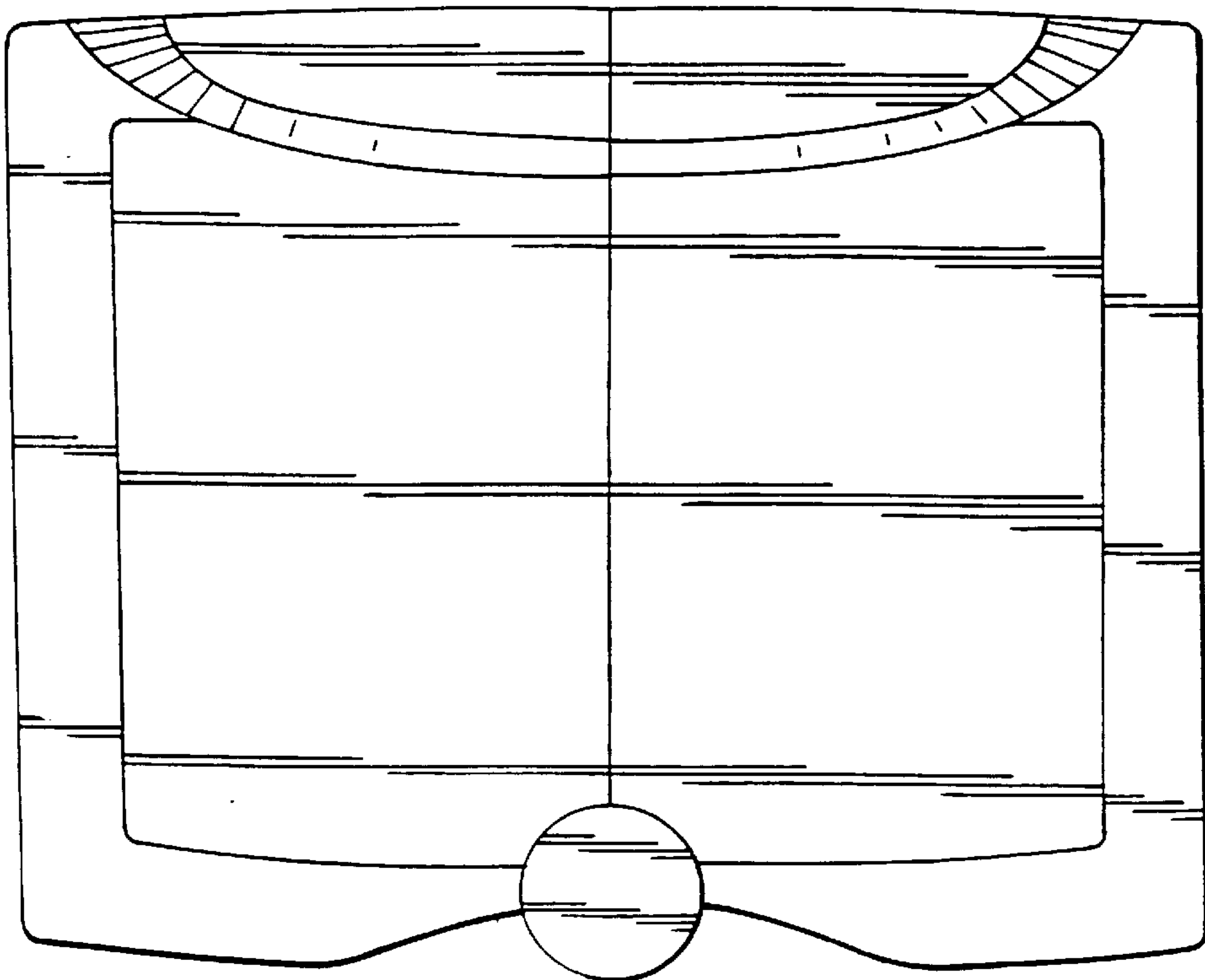
*Primary Examiner—Freda Nunn*

**1 Claim, 7 Drawing Sheets**

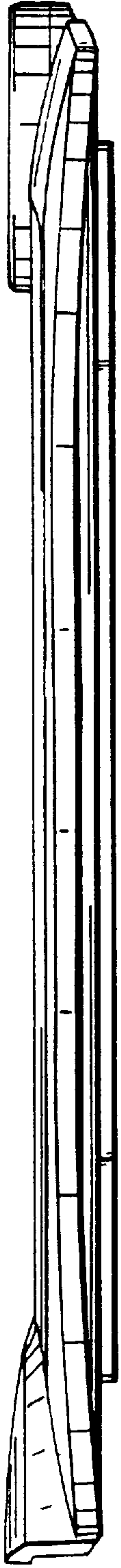




*Fig. 1*



*Fig. 6*



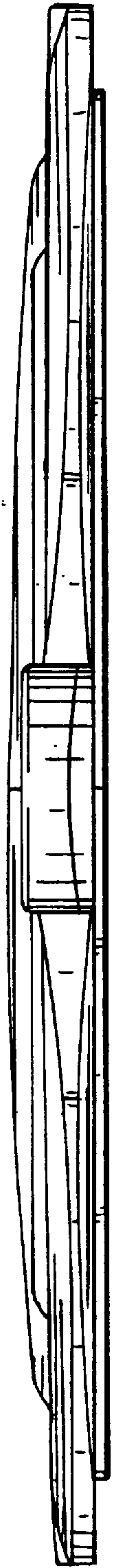
*Fig. 2*



*Fig. 3*



*Fig. 4*



*Fig. 5*



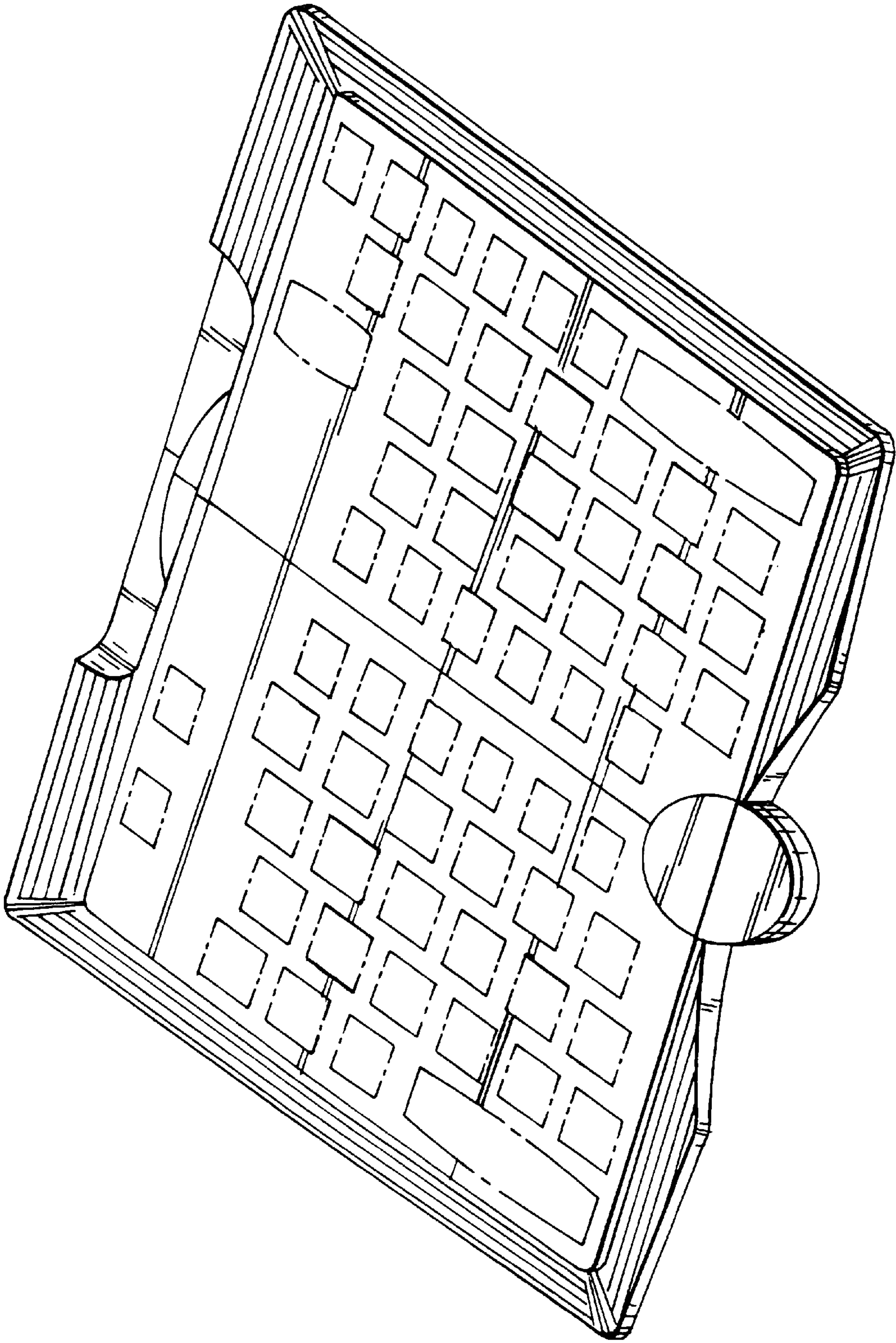
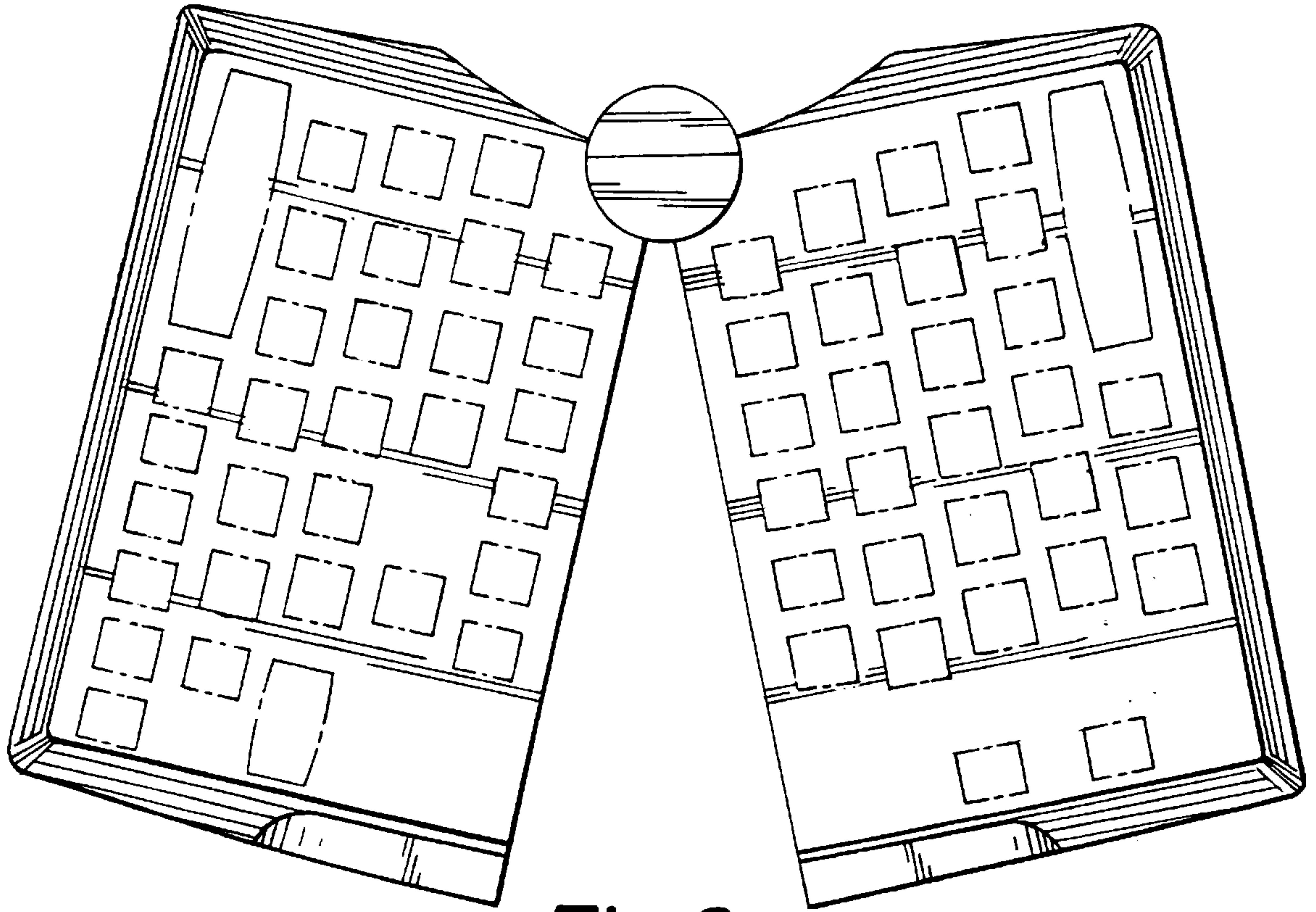
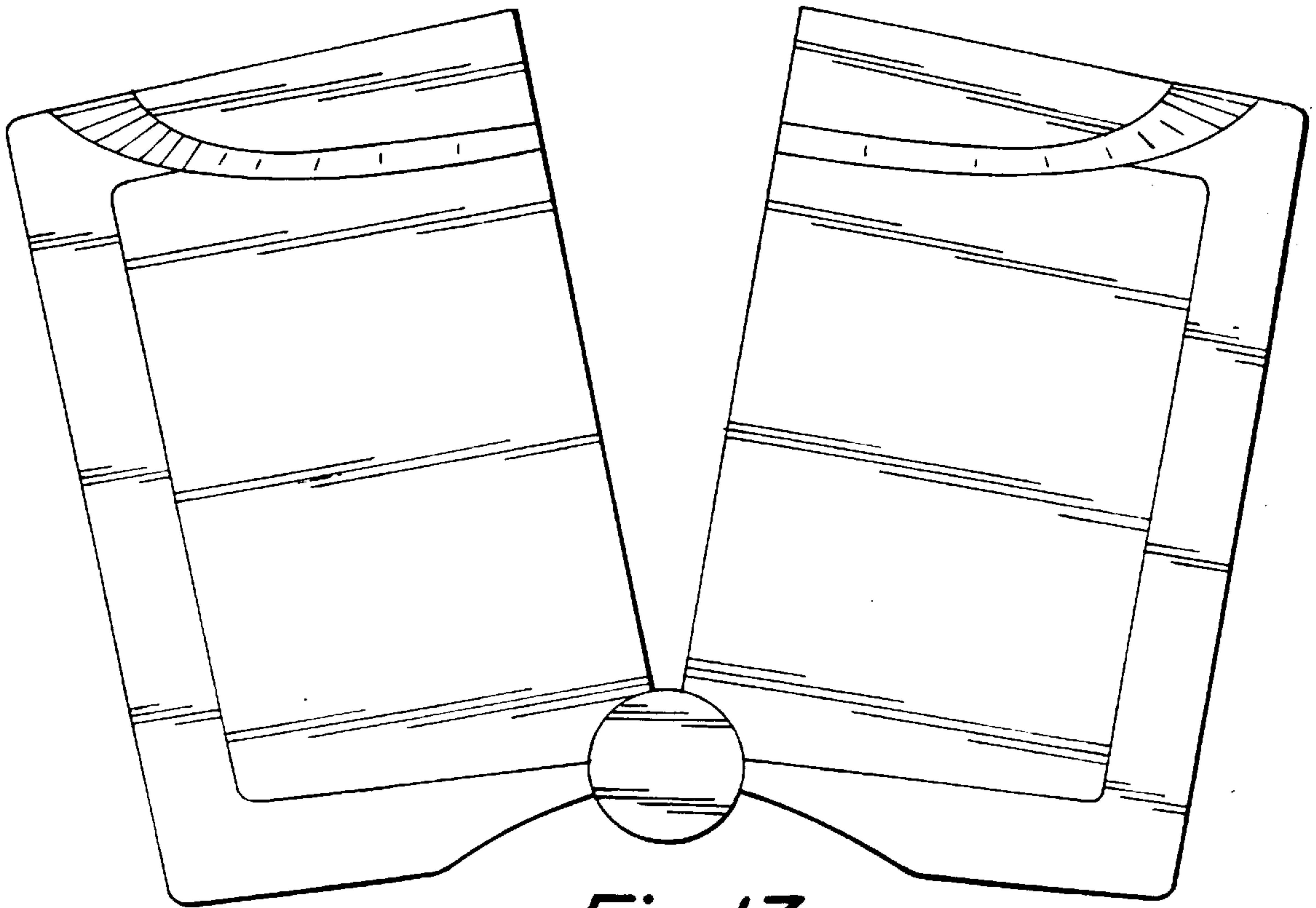


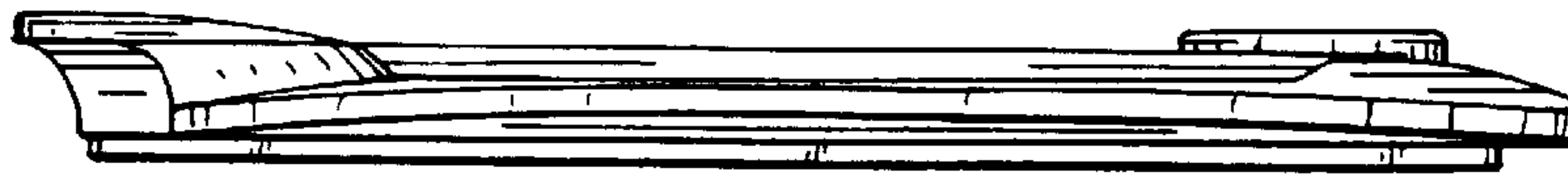
Fig. 7



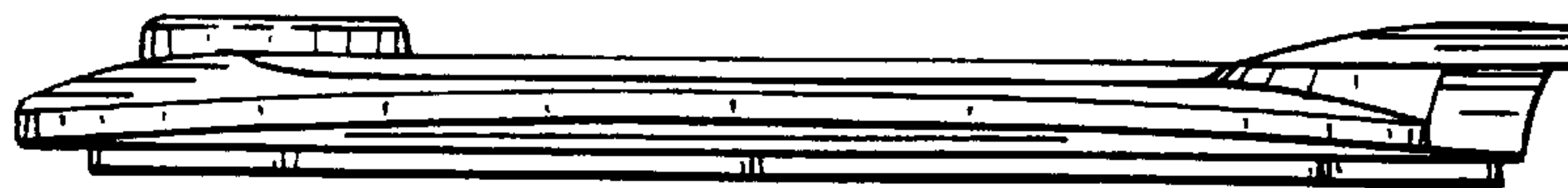
*Fig. 8*



*Fig. 13*



*Fig. 9*



*Fig. 10*



*Fig. 11*



*Fig. 12*



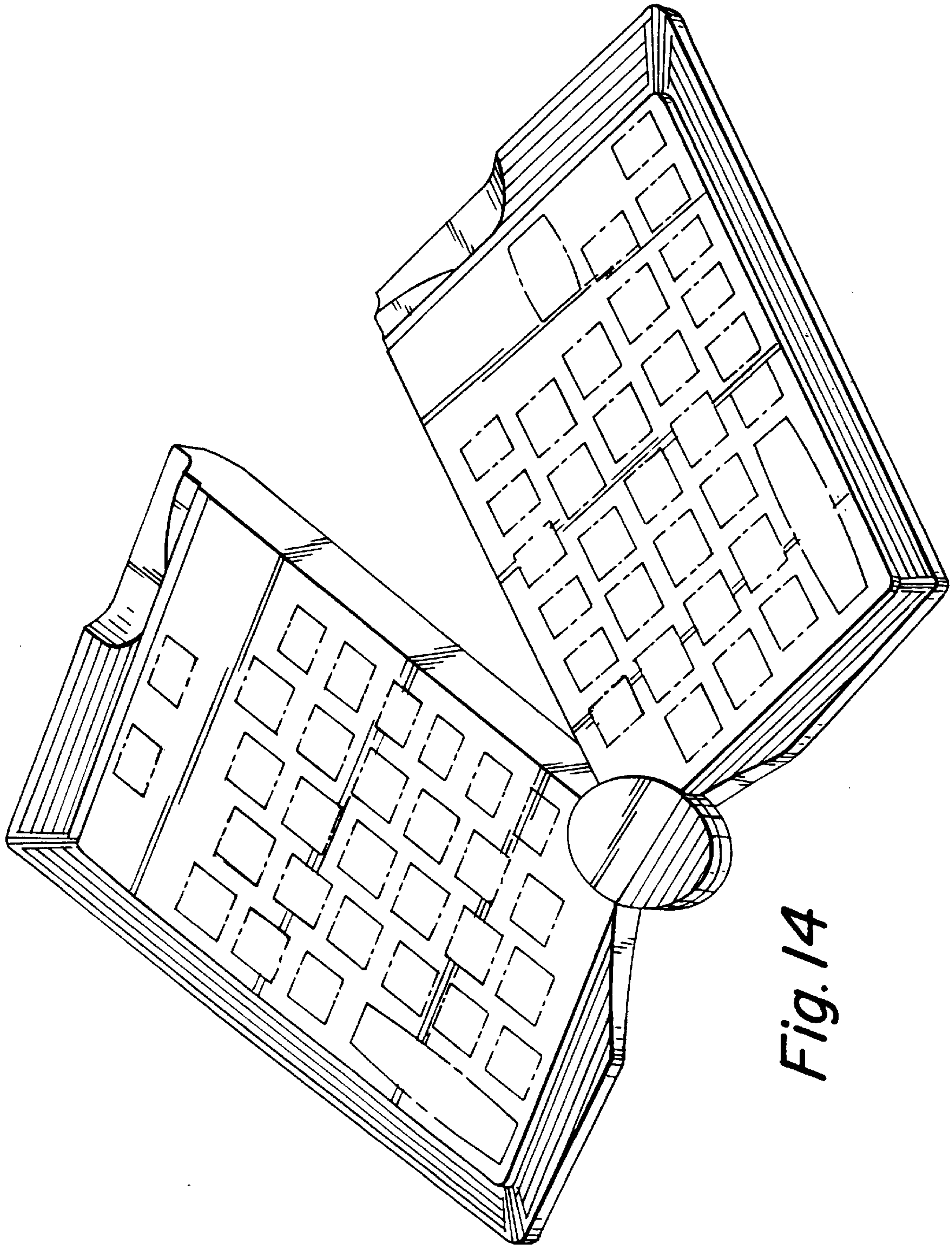
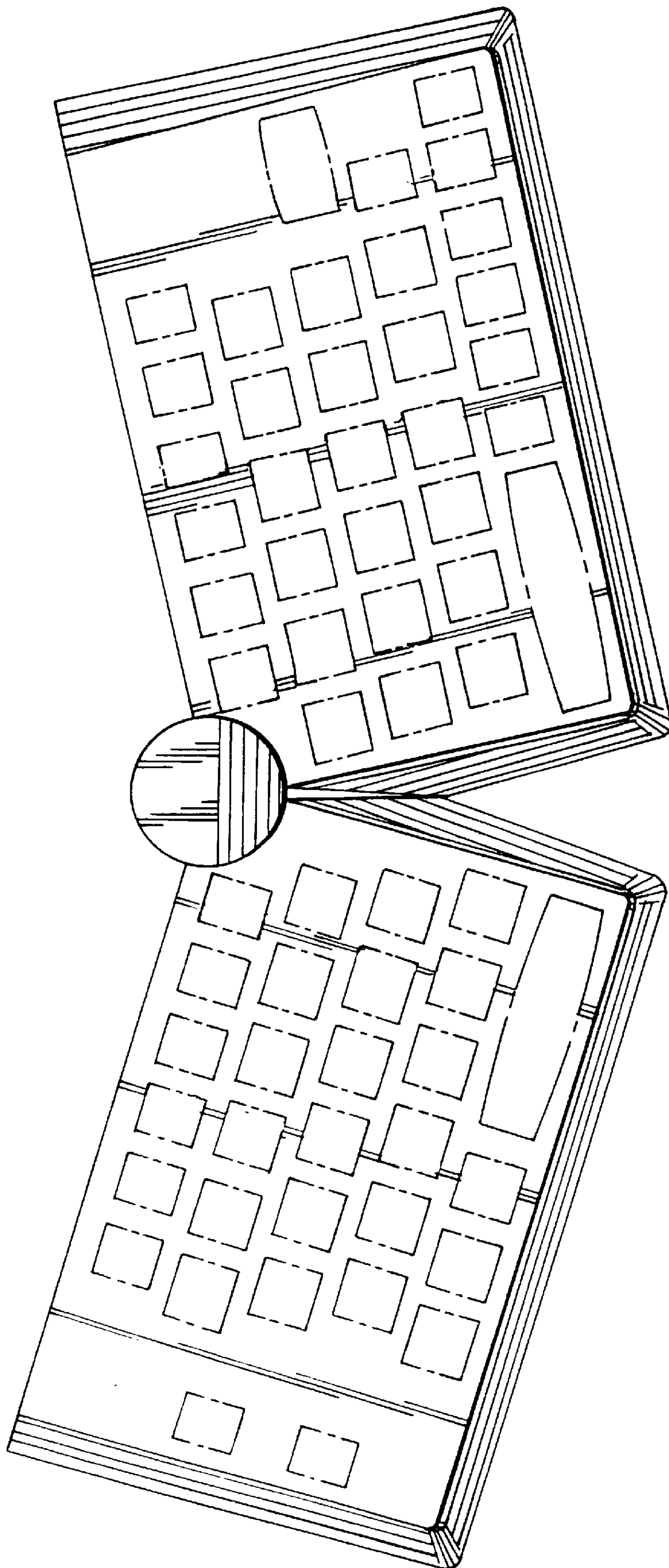


Fig. 14



*Fig. 15*