



US00D408795S

United States Patent [19]

Wells

[11] **Patent Number: Des. 408,795**

[45] **Date of Patent: **Apr. 27, 1999**

[54] **MUSIC DISPLAY PERSONAL COMPUTER**

[76] Inventor: **James D. Wells**, 1645 Pershing Ave.,
Erie, Pa. 16509

[**] Term: **14 Years**

[21] Appl. No.: **29/086,052**

[22] Filed: **Apr. 3, 1998**

[51] **LOC (6) Cl. 14-02**

[52] **U.S. Cl. D14/100; D14/115; D17/99**

[58] **Field of Search D14/100, 106,
D14/113, 115, 124-129; D17/9, 99; D19/59,
60; 364/708.1; 345/104, 133, 156, 168,
173, 87; 348/180, 184, 325, 739; D8/349,
352, 355, 356**

[56] **References Cited**

U.S. PATENT DOCUMENTS

D. 317,933 7/1991 Yoshitake D17/99

D. 354,743 1/1995 Vieira D14/100
D. 366,036 1/1996 Houlihan D14/114
D. 375,515 11/1996 Takeda et al. D17/99
D. 392,960 3/1998 Giorgia D14/114

Primary Examiner—Freda Nunn

[57] **CLAIM**

The ornamental design for a music display personal computer, as shown.

DESCRIPTION

FIG. 1 is a front elevational view of a music display personal computer;
FIG. 2 is a rear elevational view;
FIG. 3 is a left side elevational view;
FIG. 4 is a right side elevational view;
FIG. 5 is a top plan view; and,
FIG. 6 is a bottom plan view.

1 Claim, 3 Drawing Sheets

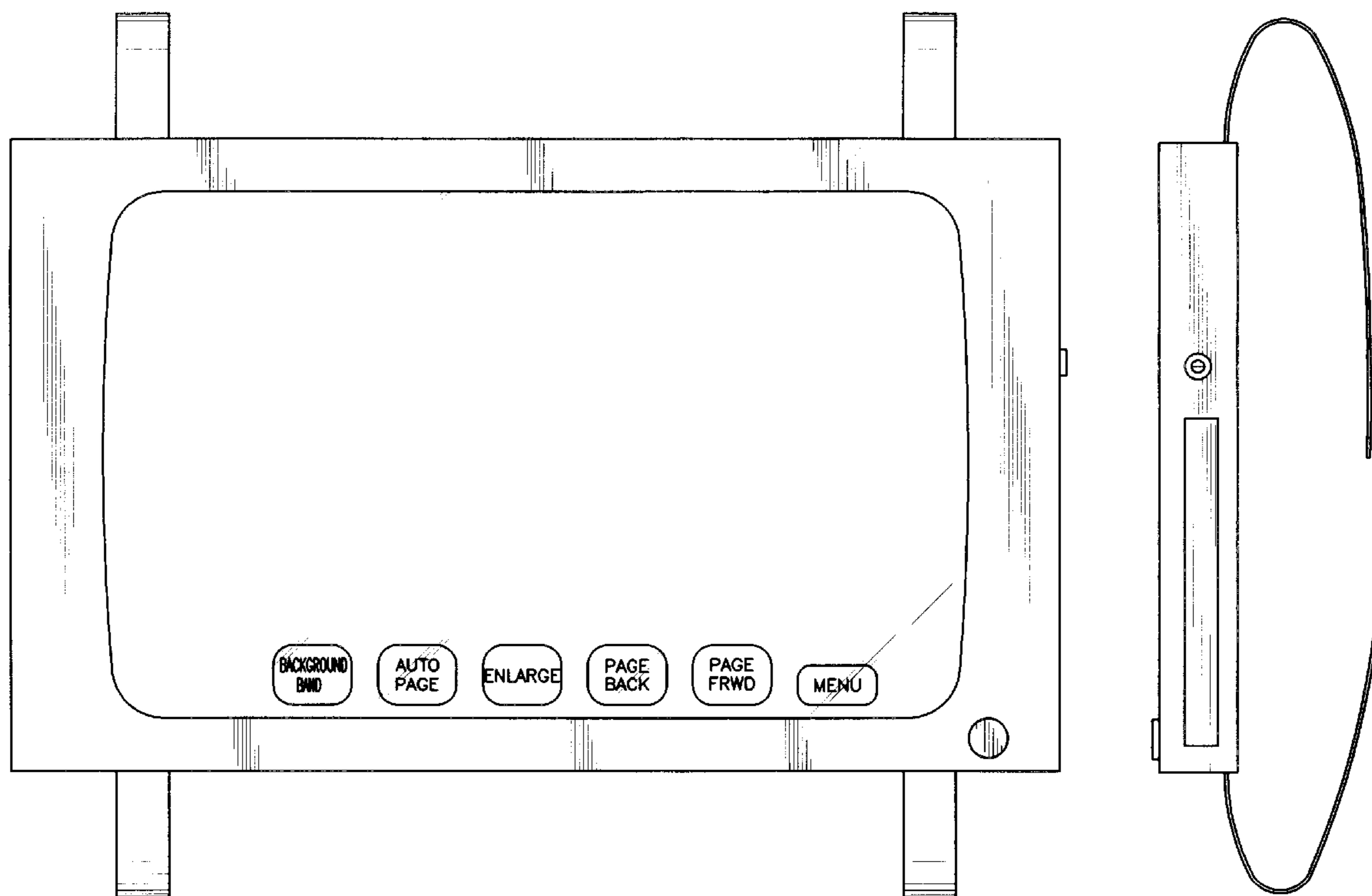

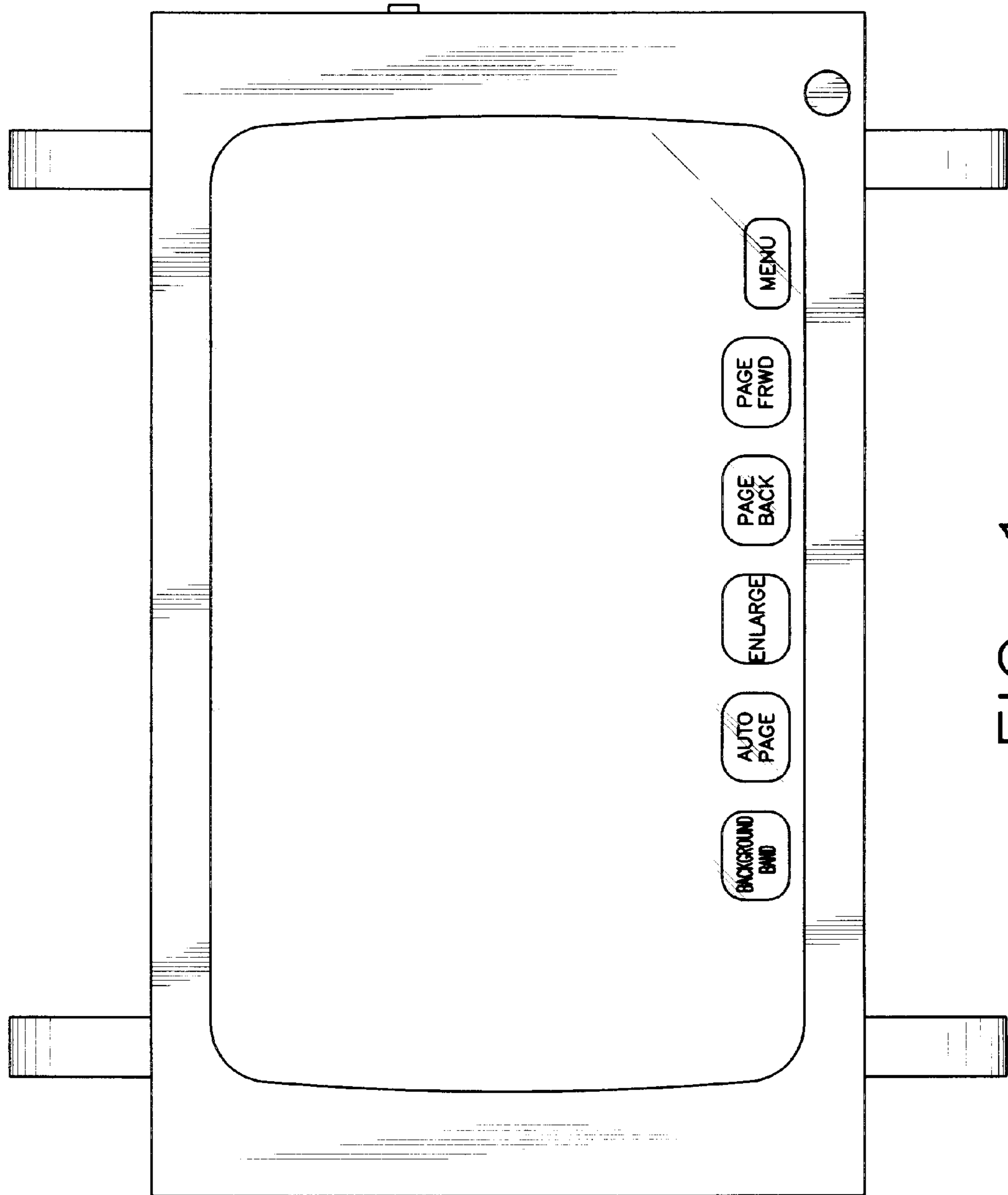

FIG. 1

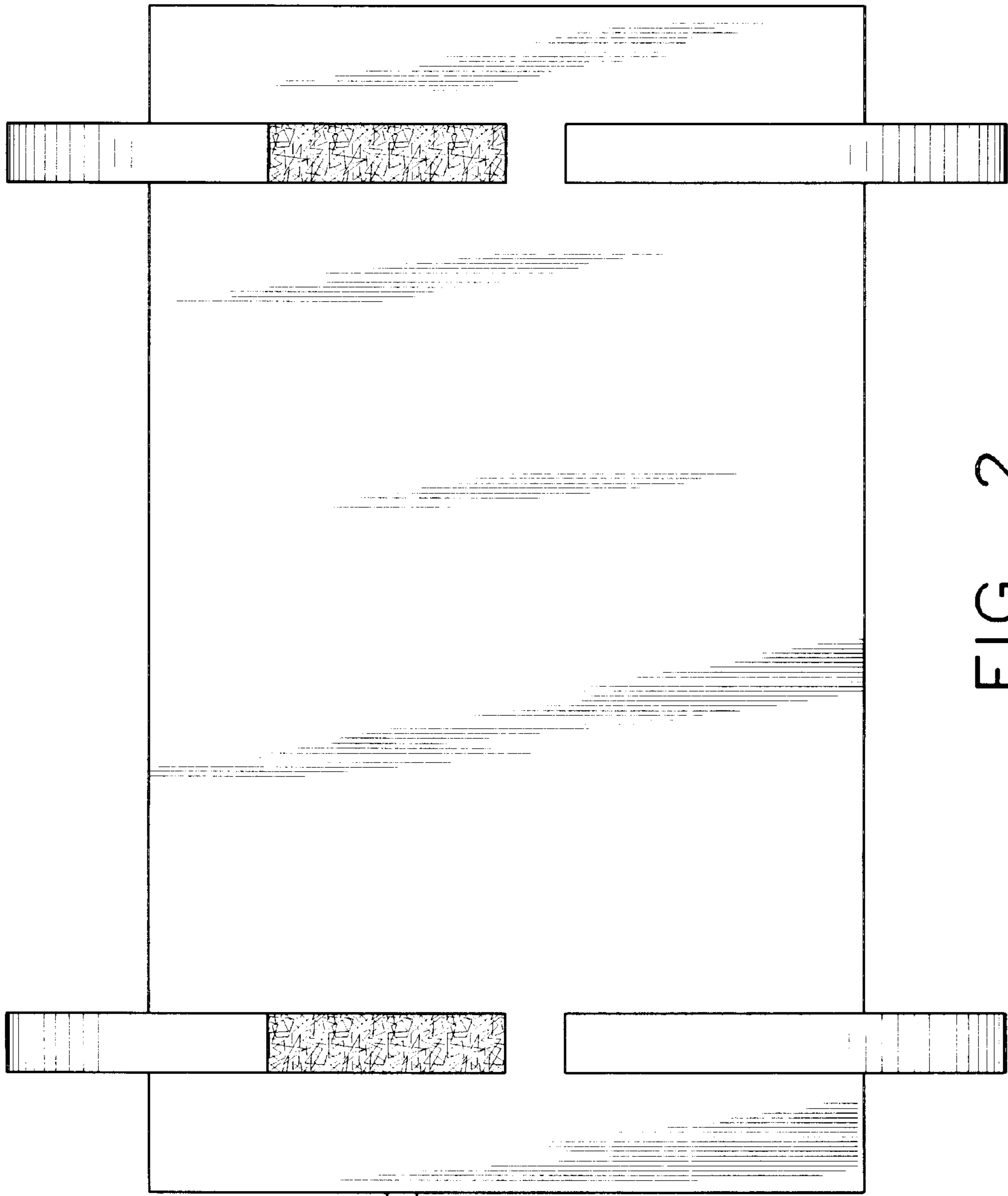

FIG. 2

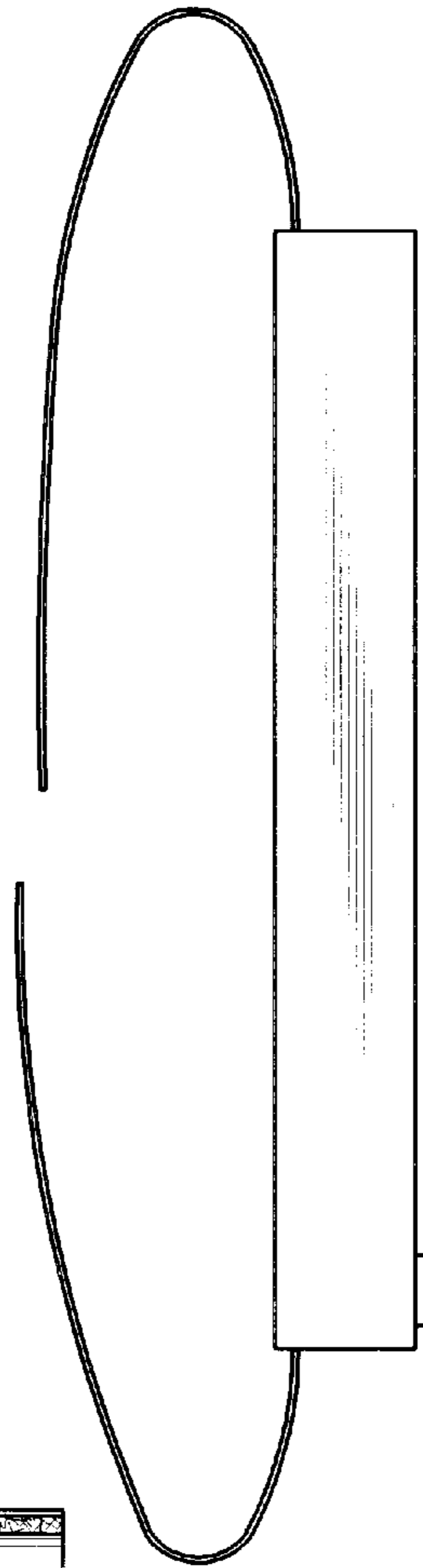

FIG. 3

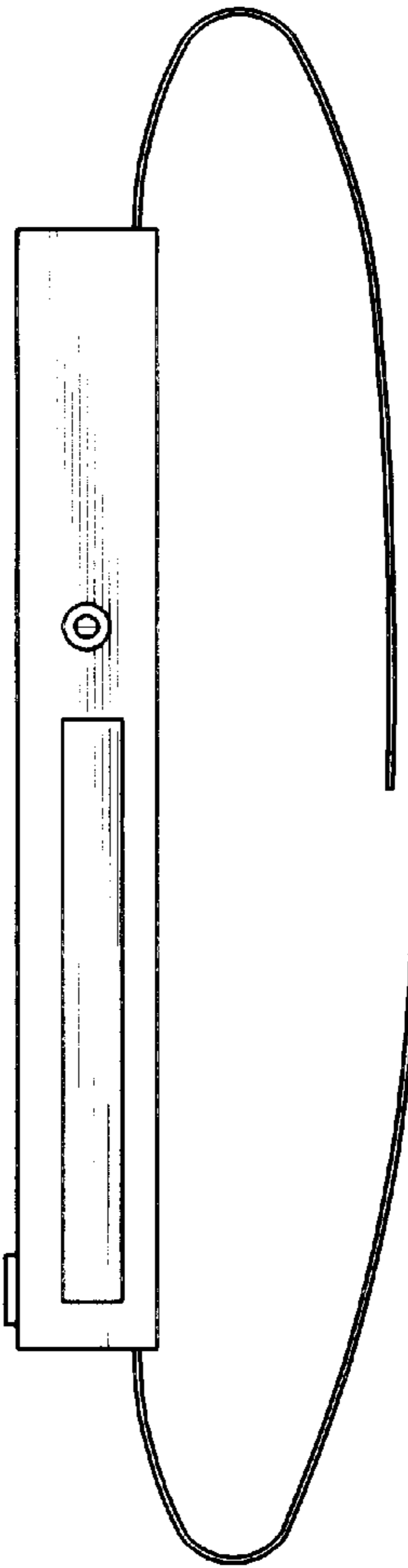

FIG. 4

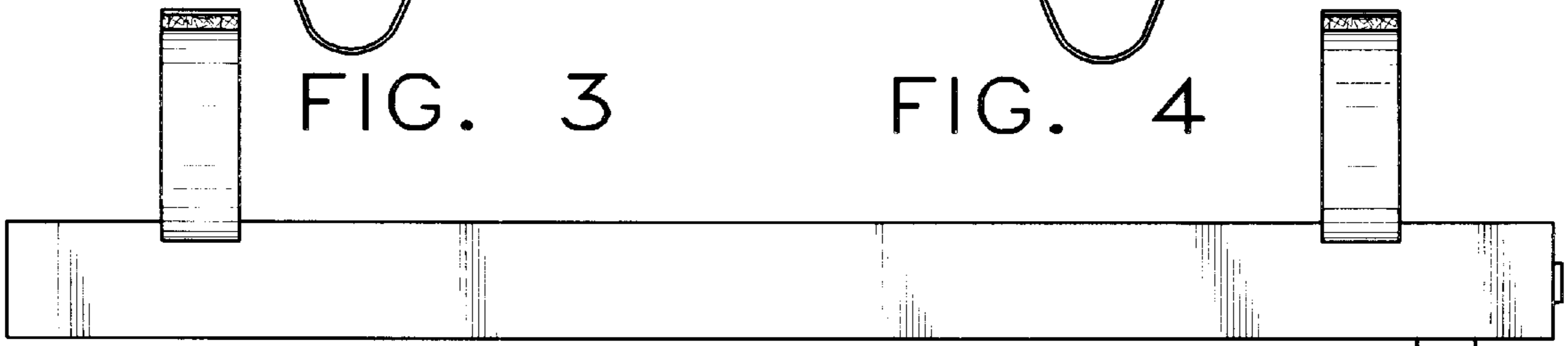

FIG. 5

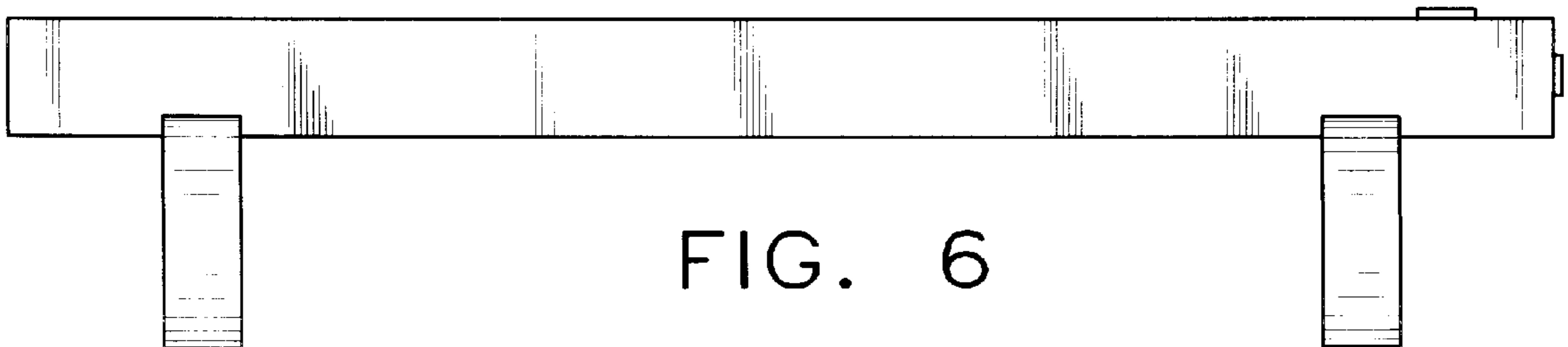

FIG. 6