



US00D408693S

United States Patent [19] Wong

[11] **Patent Number: Des. 408,693**

[45] **Date of Patent: **Apr. 27, 1999**

+
[54] **COMBINED SIEVE AND GRATER**

[76] Inventor: **Yan Kwong Wong**, Unit 17, 10th Floor,
21 Lam Hing Street, Kowloon Bay,
Kowloon, The Hong Kong Special
Administrative Region of the People's
Republic of China

[**] Term: **14 Years**

[21] Appl. No.: **29/087,772**

[22] Filed: **May 8, 1998**

[30] **Foreign Application Priority Data**

Nov. 11, 1997 [GB] United Kingdom 2070410

[51] **LOC (6) Cl.** **07-04**

[52] **U.S. Cl.** **D7/667; D7/678**

[58] **Field of Search** D7/665-668, 678,
D7/381, 412; 210/464, 470, 473, 498, 499;
241/95, 100, 168, 169, 273.1-273.4, 274

[56] **References Cited**

U.S. PATENT DOCUMENTS

D. 224,674 8/1972 Ashton et al. D7/678 X

D. 354,886 1/1995 Diefenbach D7/678
3,583,454 6/1971 Borner 241/95

Primary Examiner—Terry A. Wallace
Attorney, Agent, or Firm—Salter & Michaelson

[57] **CLAIM**

The ornamental design for a combined sieve and grater, as shown.

DESCRIPTION

FIG. 1 is a perspective view of a combined sieve and grater showing my new design;

FIG. 2 is a top plan view thereof;

FIG. 3 is a bottom plan view thereof;

FIG. 4 is a elevational view of one side thereof;

FIG. 5 is an elevational view of an opposite side thereof;

FIG. 6 is an elevational view of one end thereof; and,

FIG. 7 is an elevational view of an opposite end thereof.

1 Claim, 3 Drawing Sheets

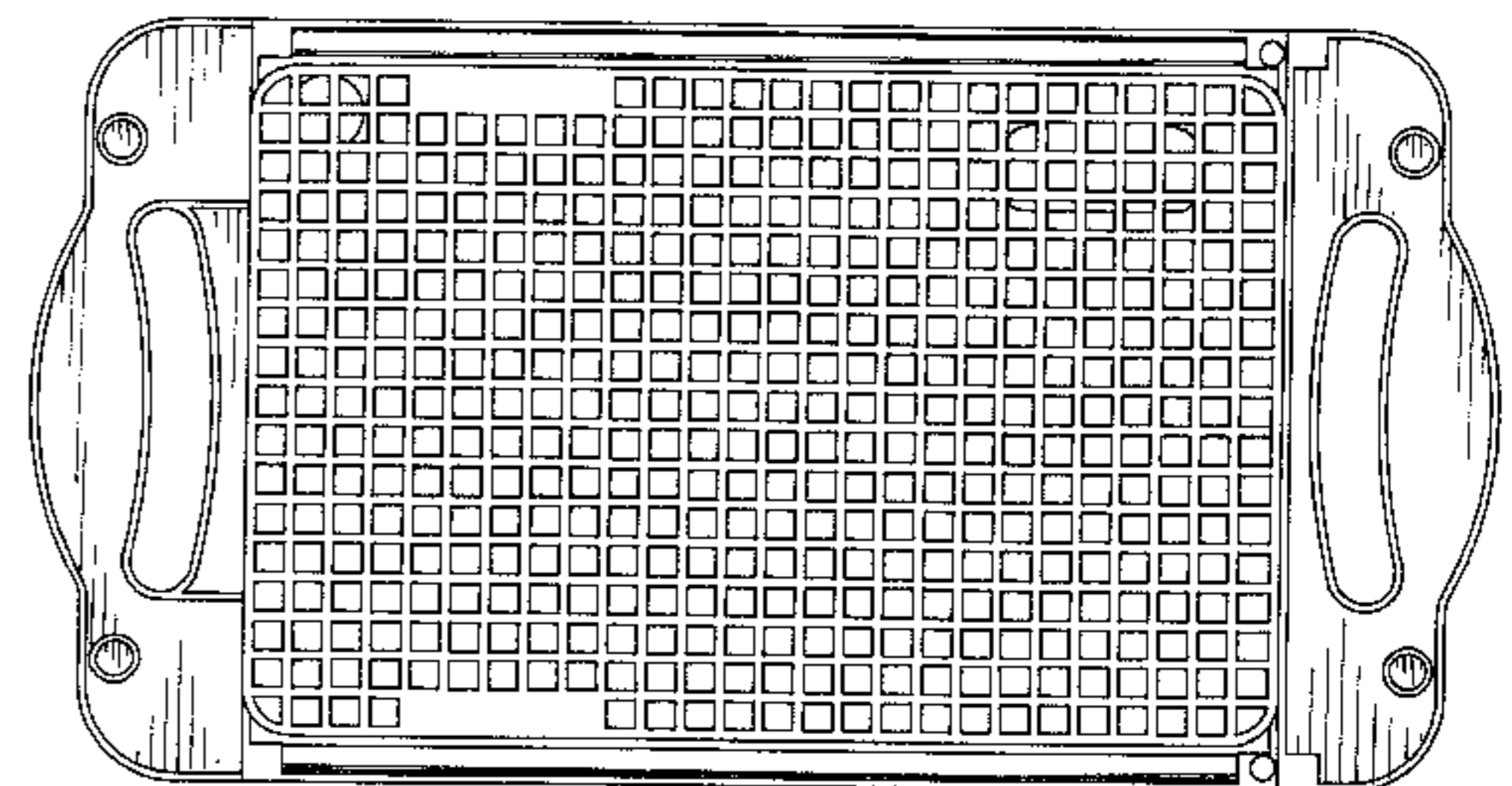
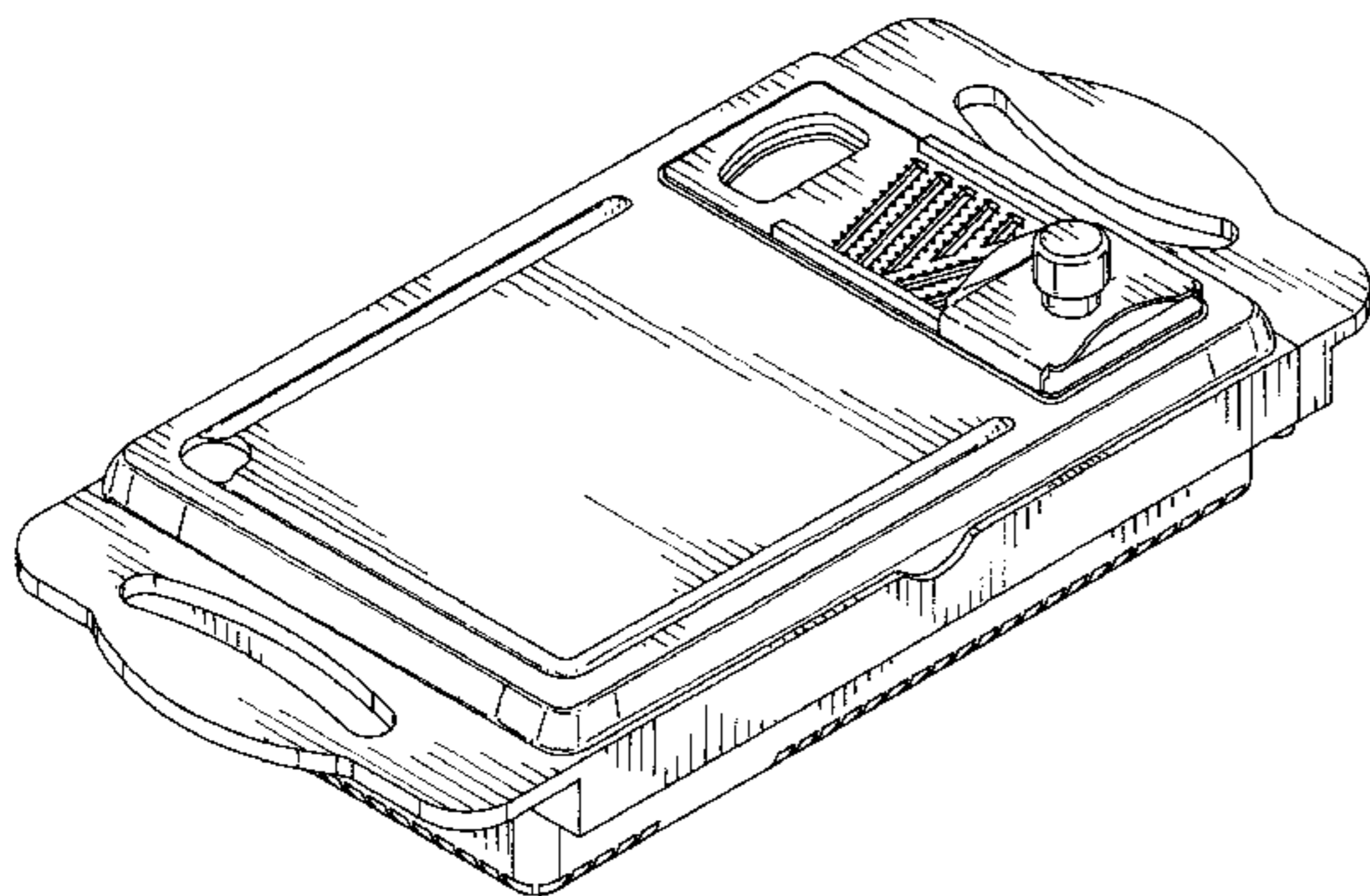

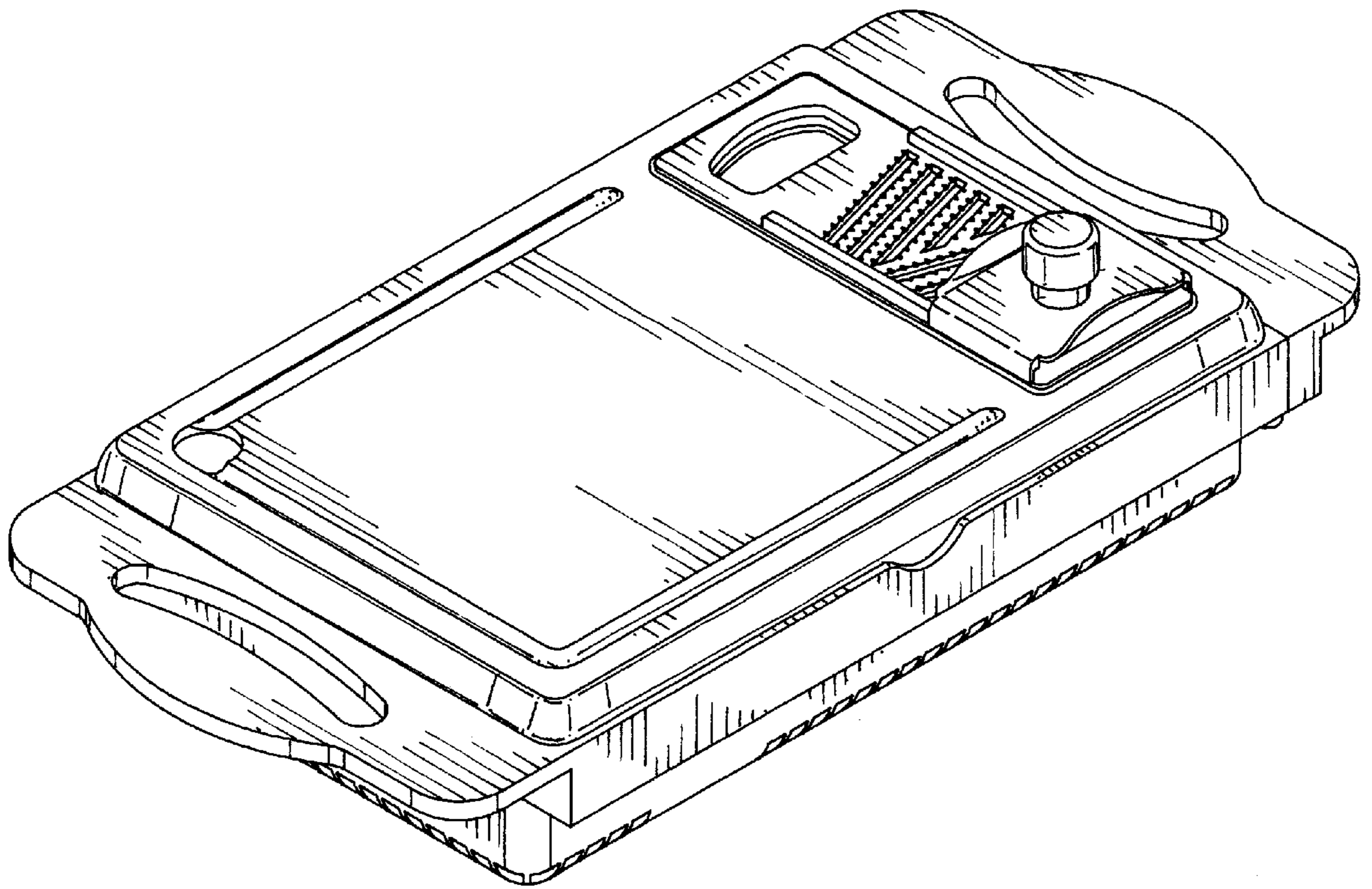

FIG. 1

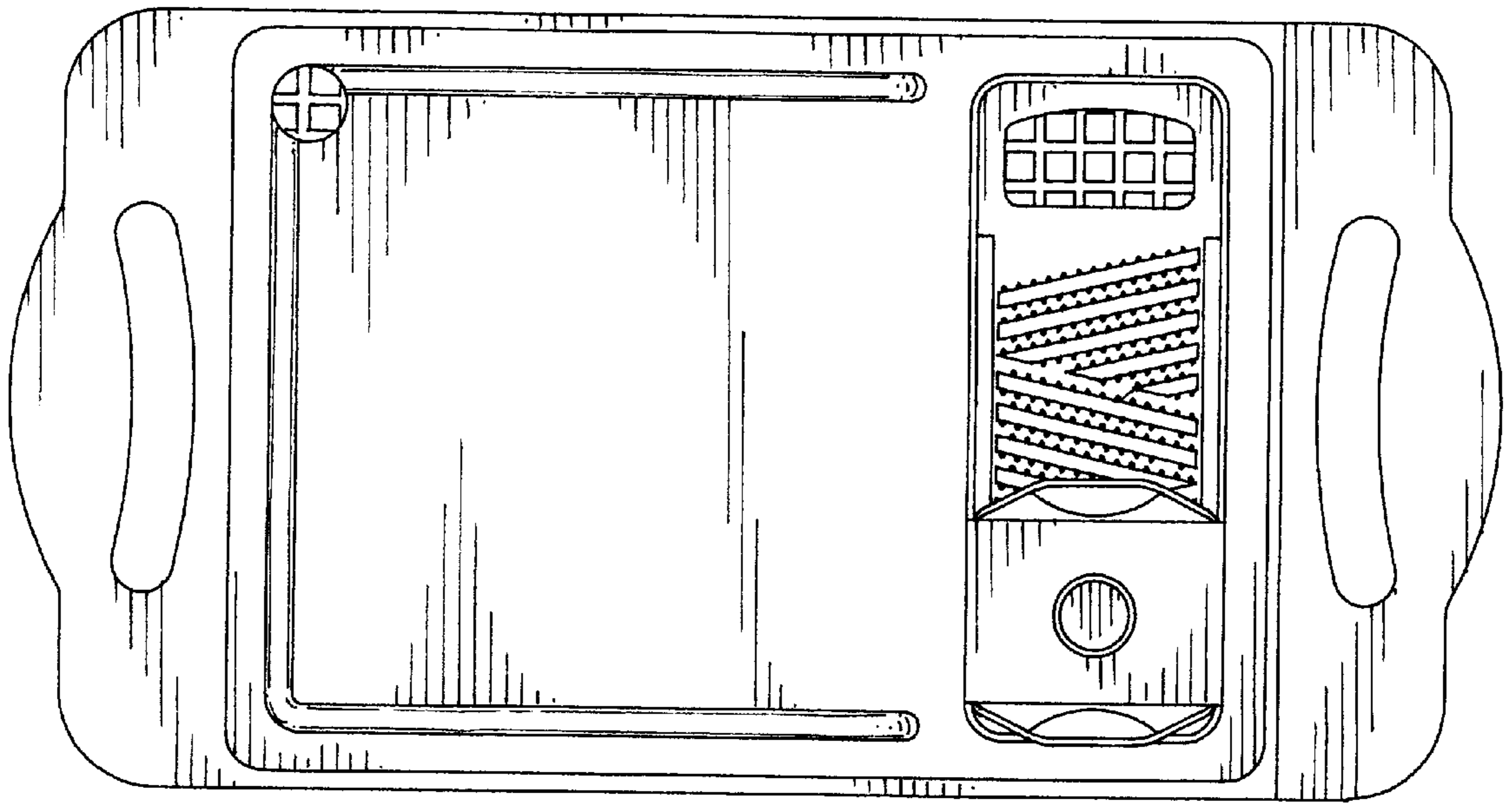

FIG. 2

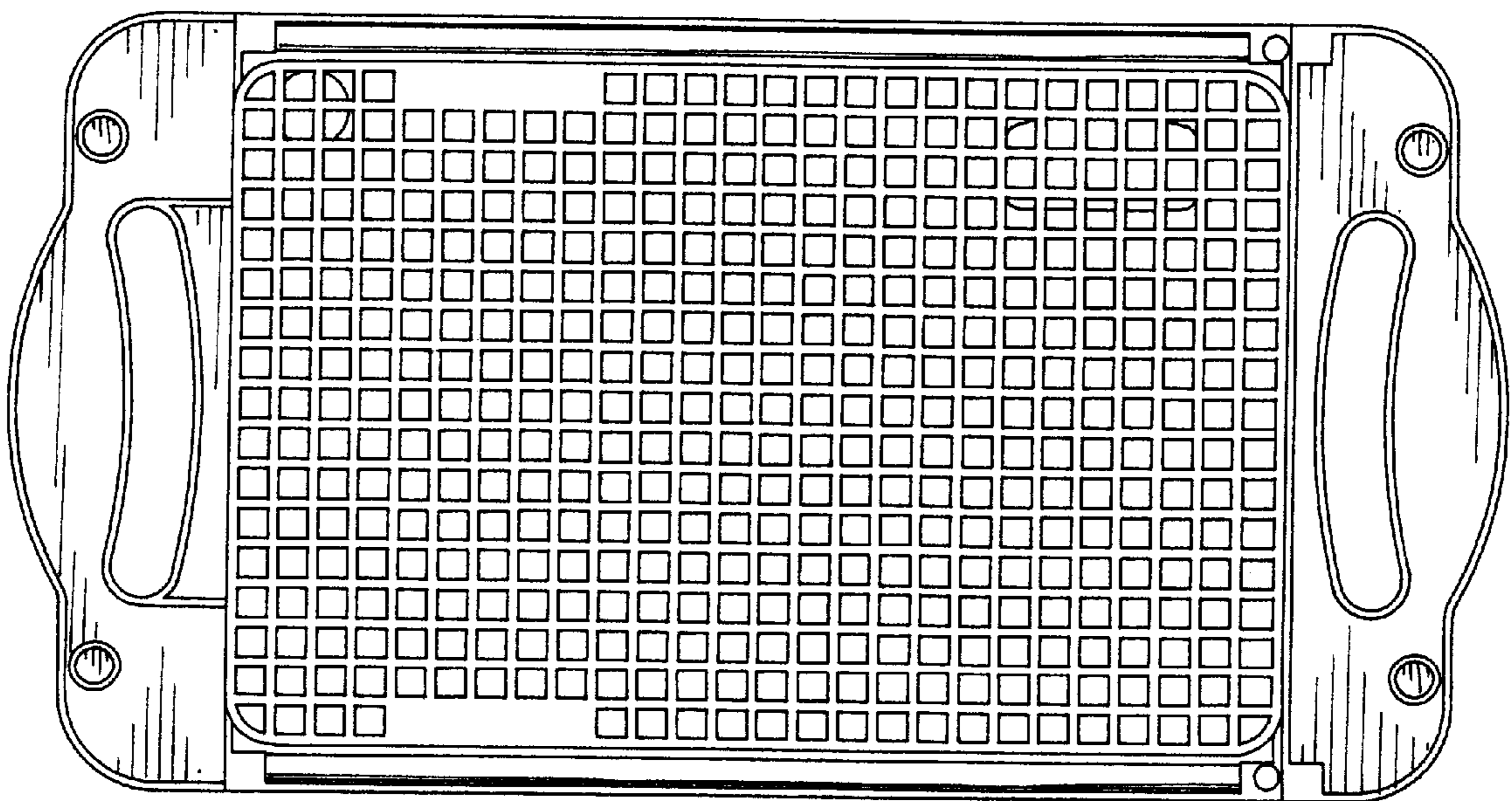

FIG. 3

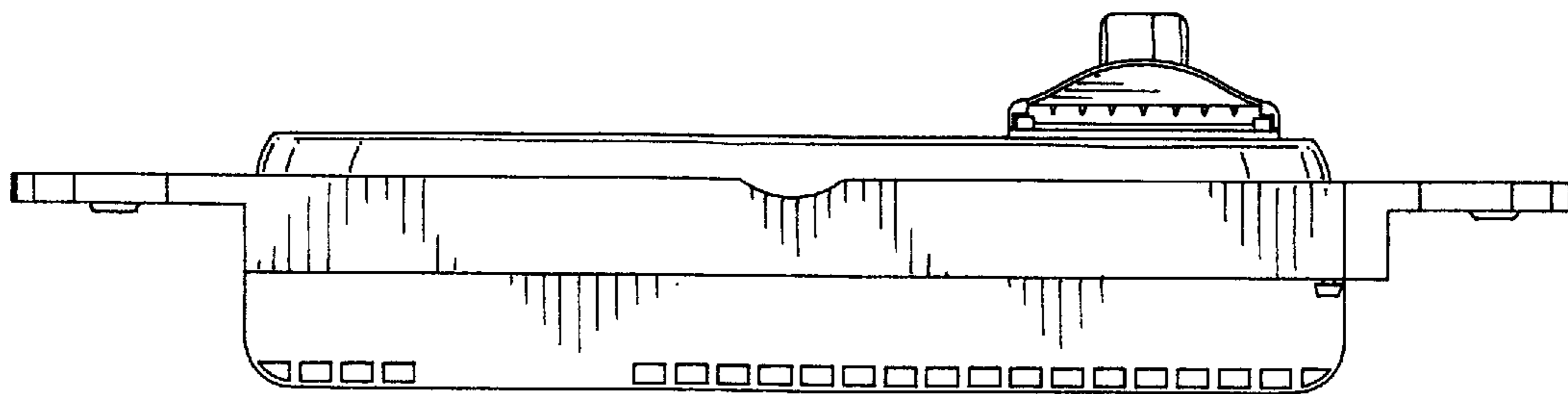

FIG. 4

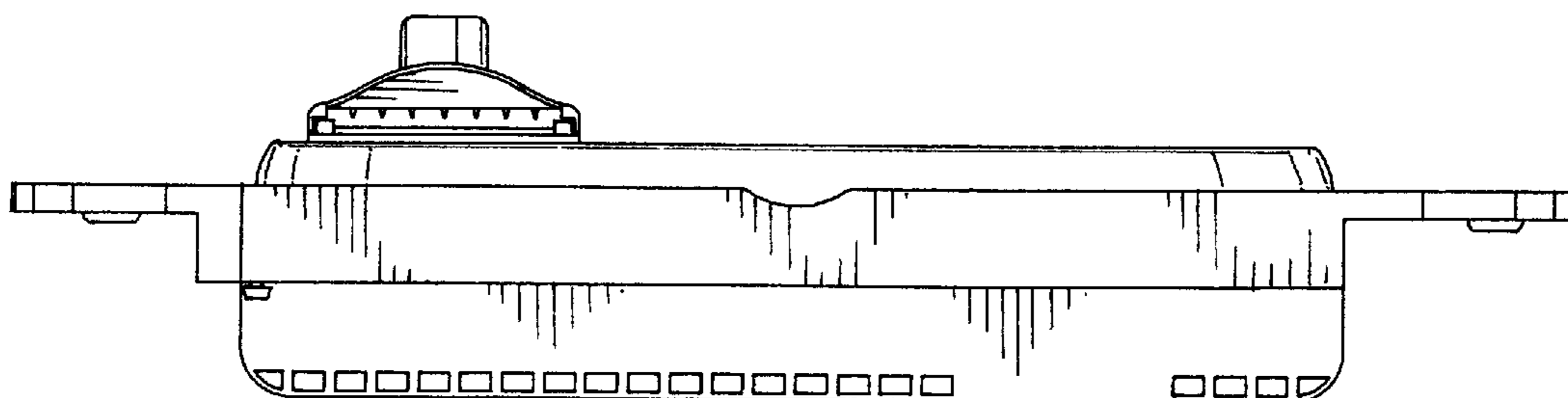

FIG. 5

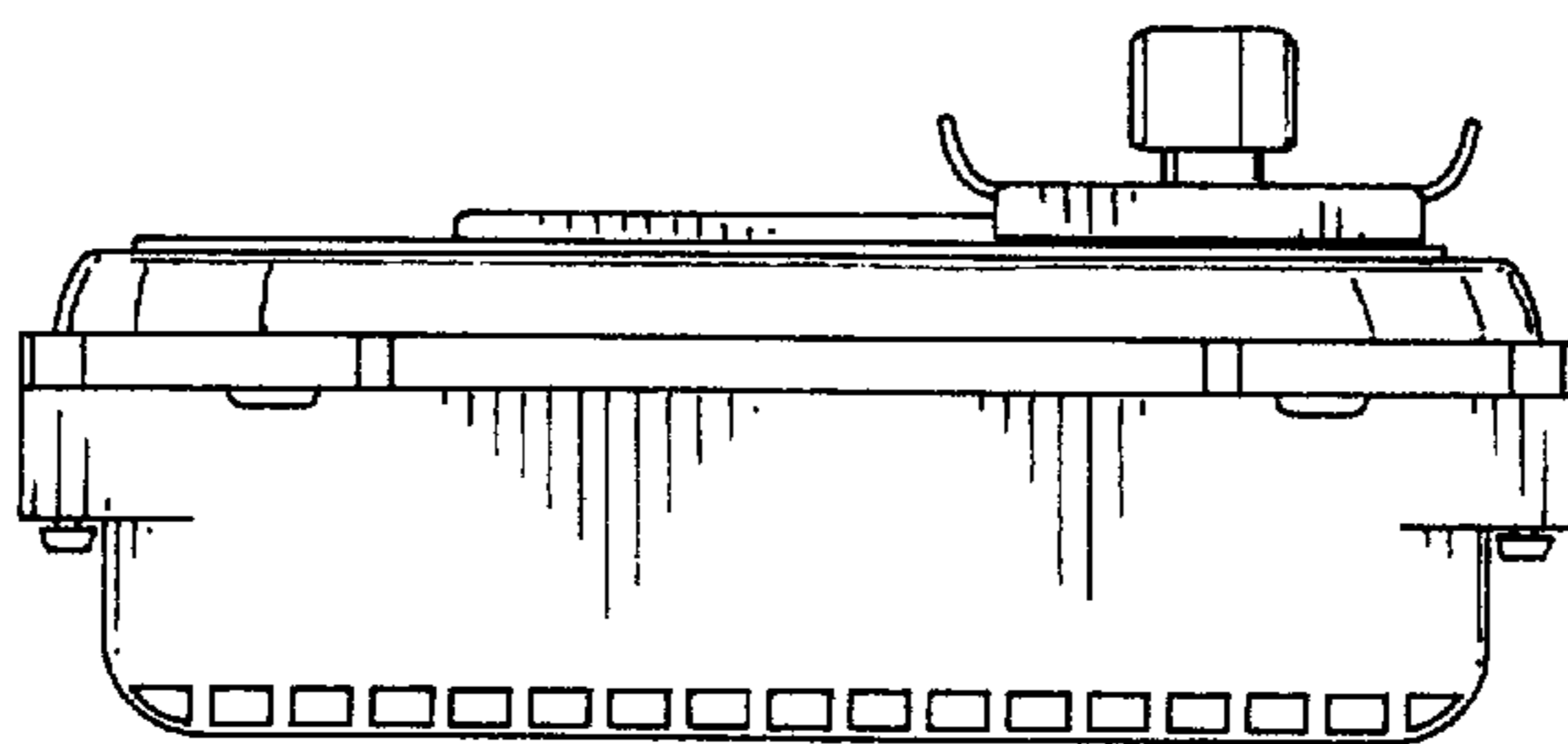

FIG. 6

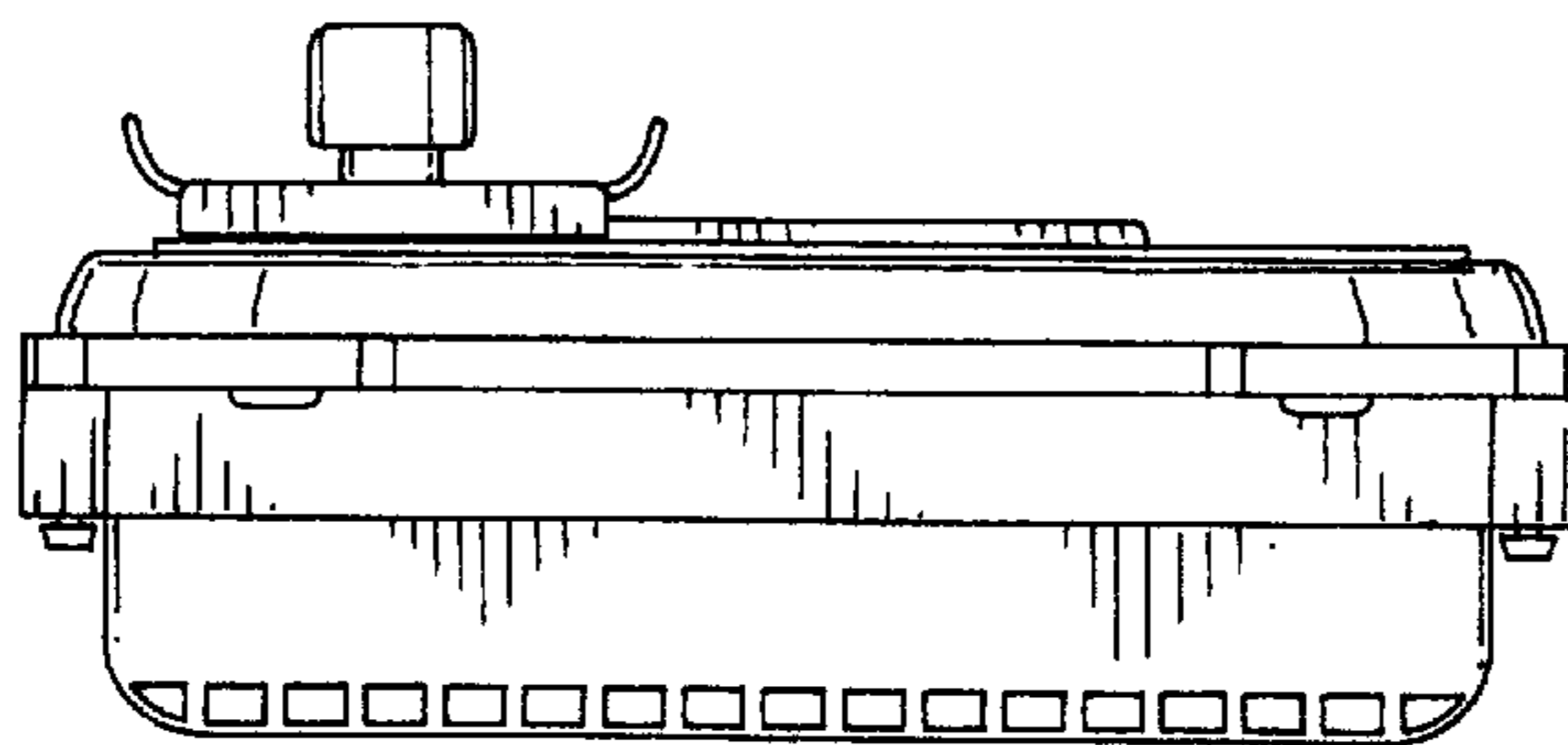

FIG. 7