



US00D408514S

United States Patent [19]
Horng

[11] **Patent Number: Des. 408,514**
[45] **Date of Patent: **Apr. 20, 1999**

[54] **HEAT DISSIPATION FAN**

[75] **Inventor: Alex Horng, Kaohsiung, Taiwan**

[73] **Assignee: Sunonwealth Electric Machine Industry Co., Ltd., Taiwan**

[**] **Term: 14 Years**

[21] **Appl. No.: 29/077,607**

[22] **Filed: Oct. 7, 1997**

[51] **LOC (6) Cl. 23-04**

[52] **U.S. Cl. D23/370; D23/379**

[58] **Field of Search D23/370, 379;**
415/176, 177, 178, 211.2; 361/697, 695;
165/80.3, 121; D14/114

[56] **References Cited**

U.S. PATENT DOCUMENTS

5,079,438	1/1992	Heung	361/695
5,288,203	2/1994	Thomas	415/178
5,309,983	5/1994	Bailey	165/80.3
5,494,098	2/1996	Morosas	165/80.3
5,582,506	12/1996	Hong	415/177
5,629,834	5/1997	Kodama et al.	415/176
5,638,895	6/1997	Dodson	165/80.3
5,689,404	11/1997	Katsui	415/178

FOREIGN PATENT DOCUMENTS

3408139 9/1985 Germany 361/695

Primary Examiner—Lisa Lichtenstein

Attorney, Agent, or Firm—Pillsbury Madison & Sutro LLP

[57] **CLAIM**

The ornamental design for a heat dissipation fan, as shown and described.

DESCRIPTION

FIG. 1 is a perspective view of a heat dissipation fan showing a first embodiment of my new design;
 FIG. 2 is a top plan view thereof;
 FIG. 3 is a right side elevational view thereof;
 FIG. 4 is a front elevational view thereof;
 FIG. 5 is a rear elevational view thereof;
 FIG. 6 is a left side elevational view thereof; and
 FIG. 7 is a bottom plan view thereof.
 FIG. 8 is a perspective view of a heat dissipation fan showing a second embodiment of my new design;
 FIG. 9 is a top plan view of FIG. 8;
 FIG. 10 is a right side elevational view of FIG. 8;
 FIG. 11 is a front elevational view of FIG. 8;
 FIG. 12 is a rear elevational view of FIG. 8;
 FIG. 13 is a left side elevational view of FIG. 8; and,
 FIG. 14 is a bottom plan view of FIG. 8.

1 Claim, 8 Drawing Sheets

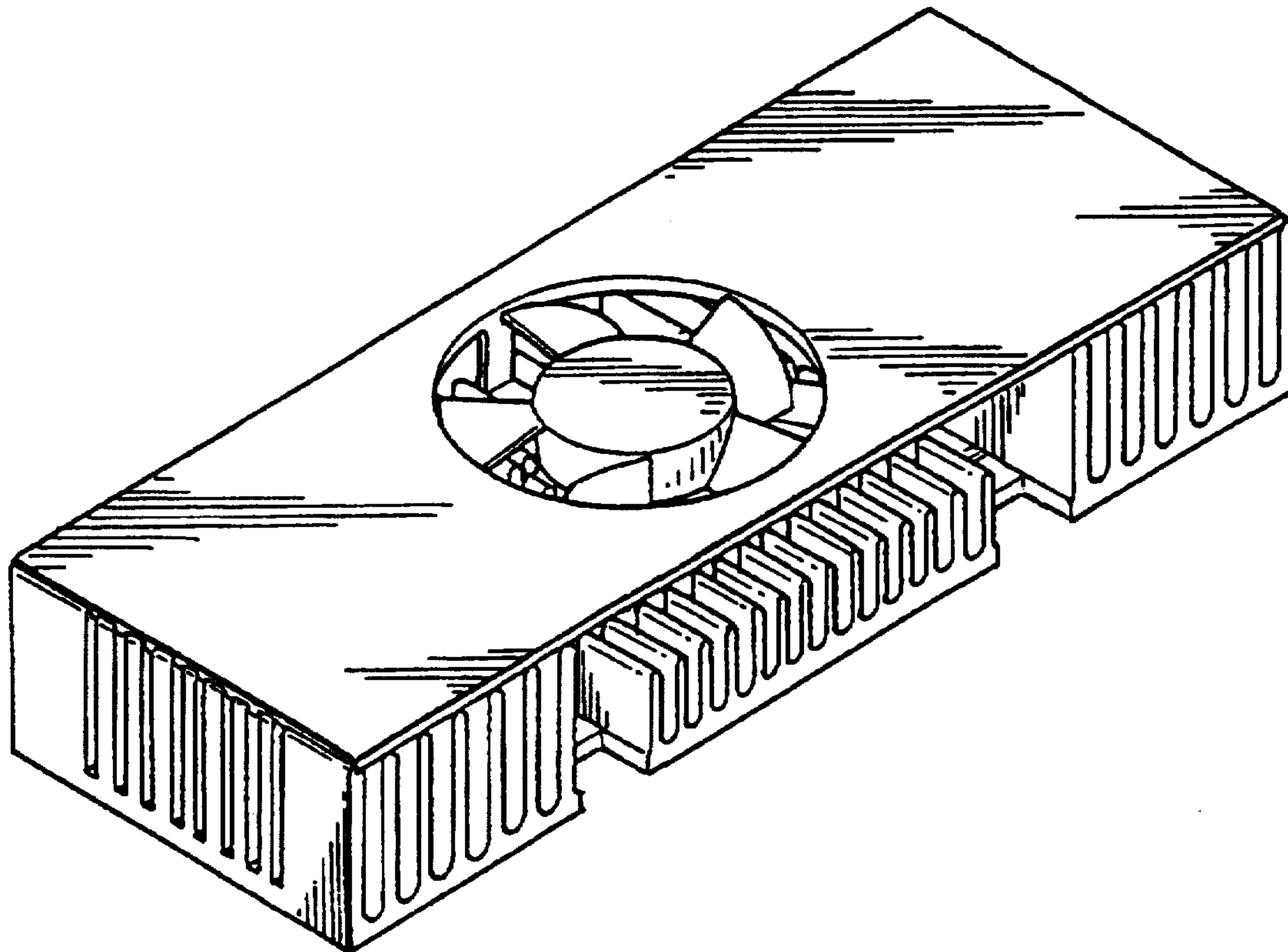

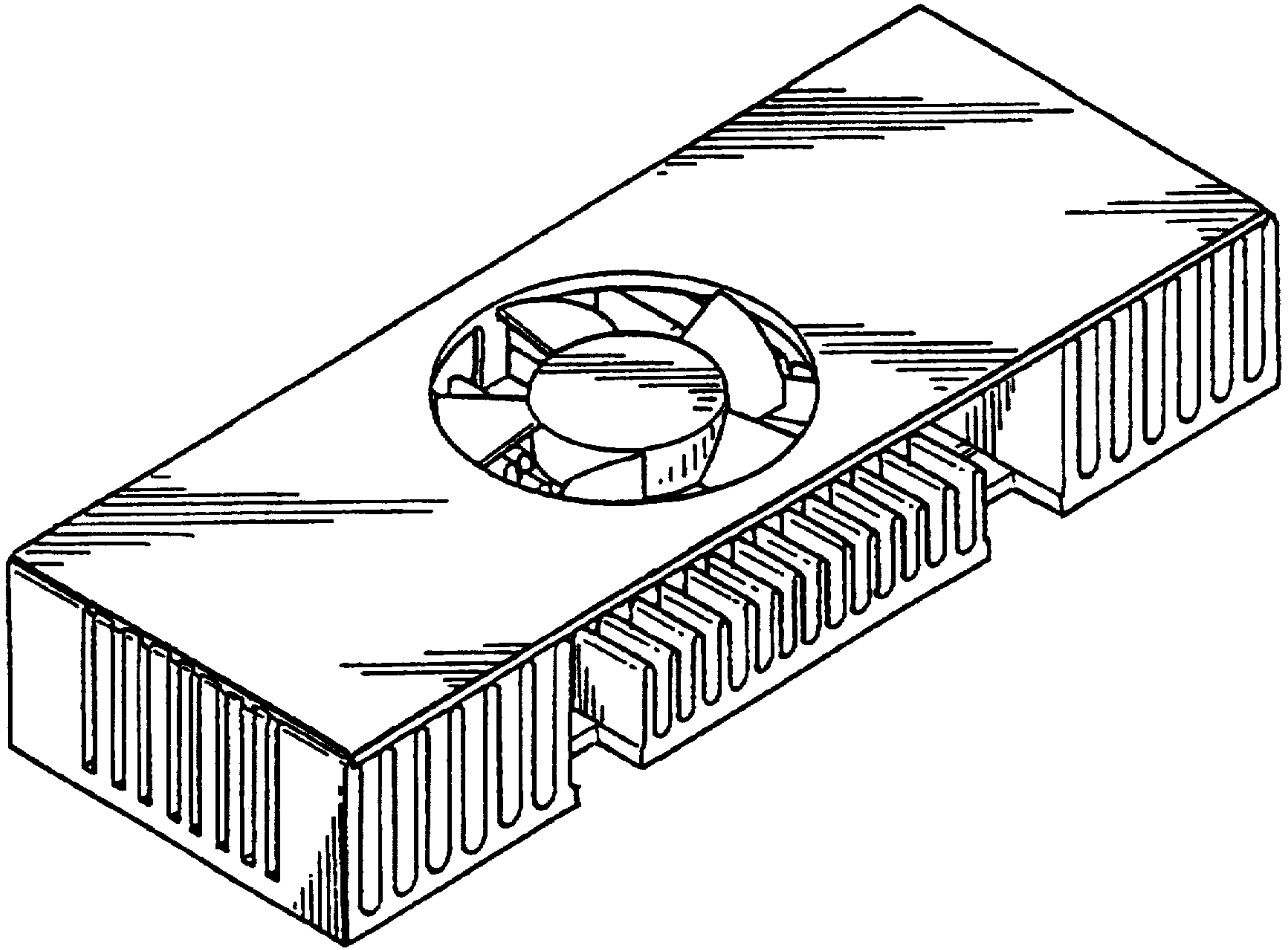

FIG. 1

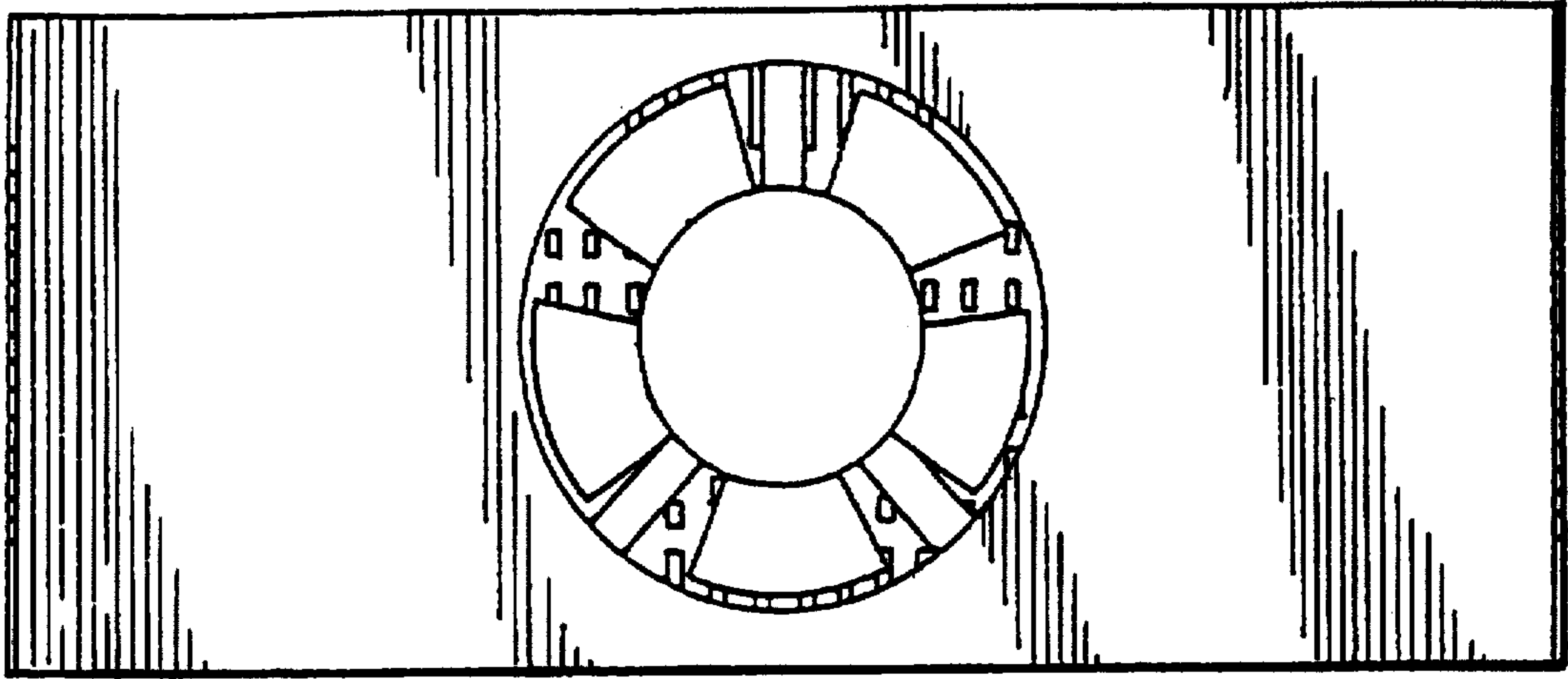

FIG. 2

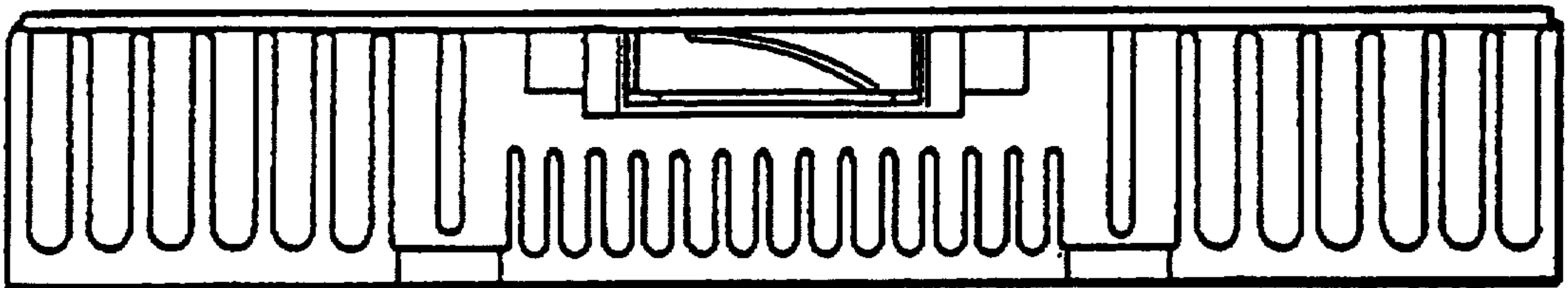

FIG. 3

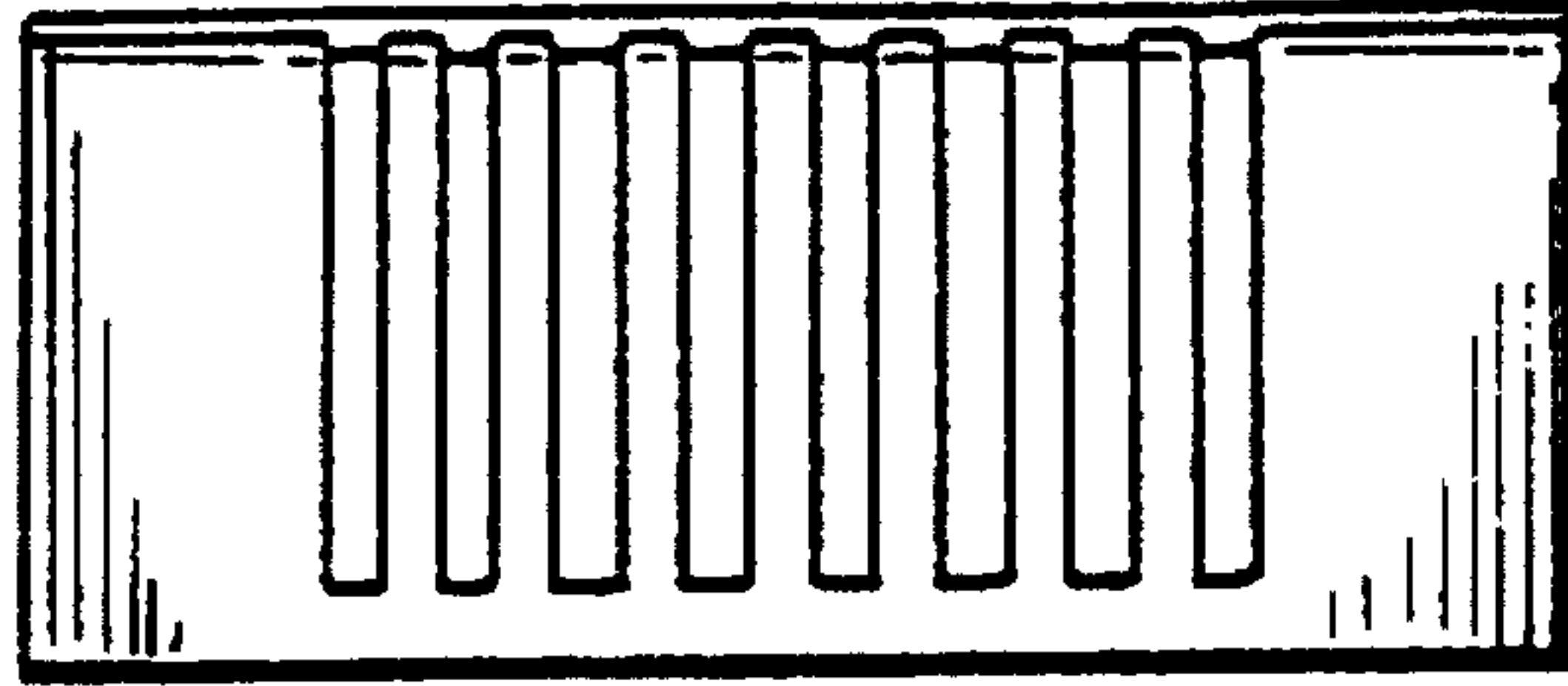

FIG. 4

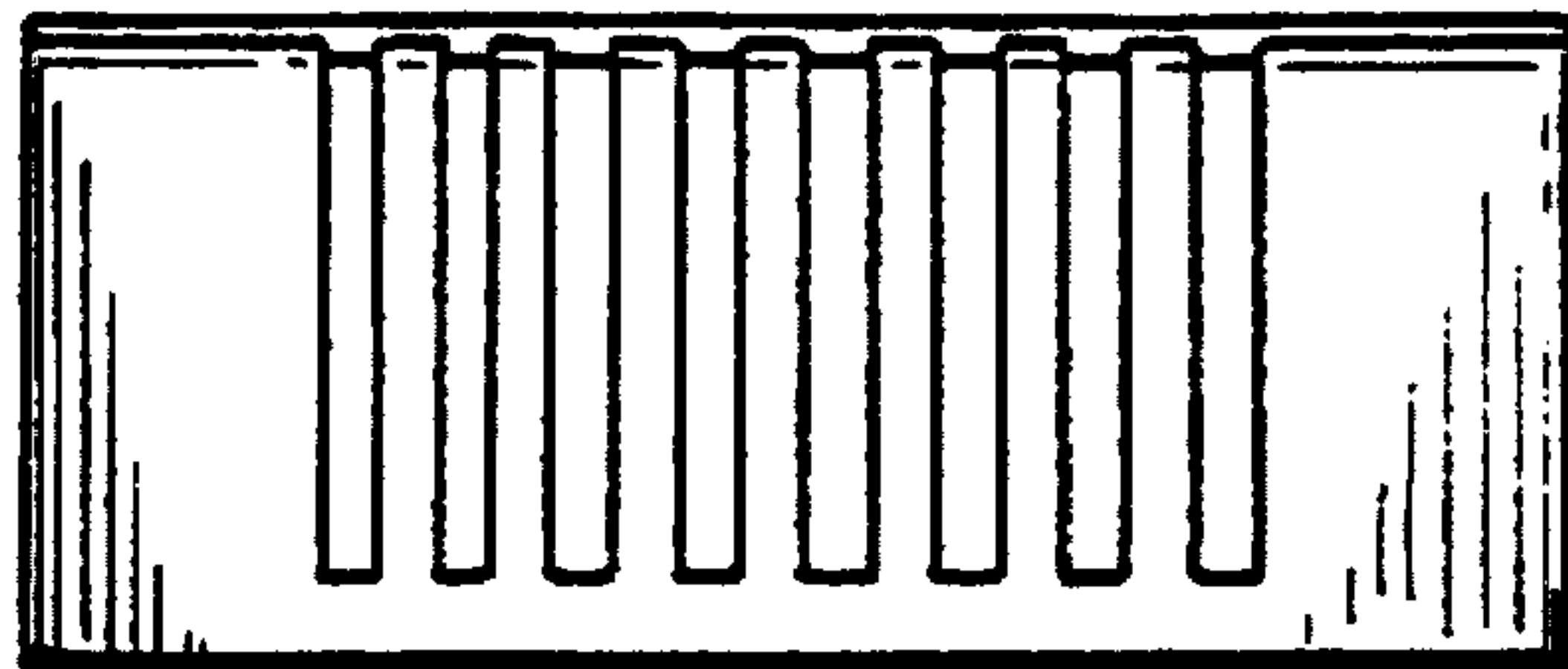

FIG. 5

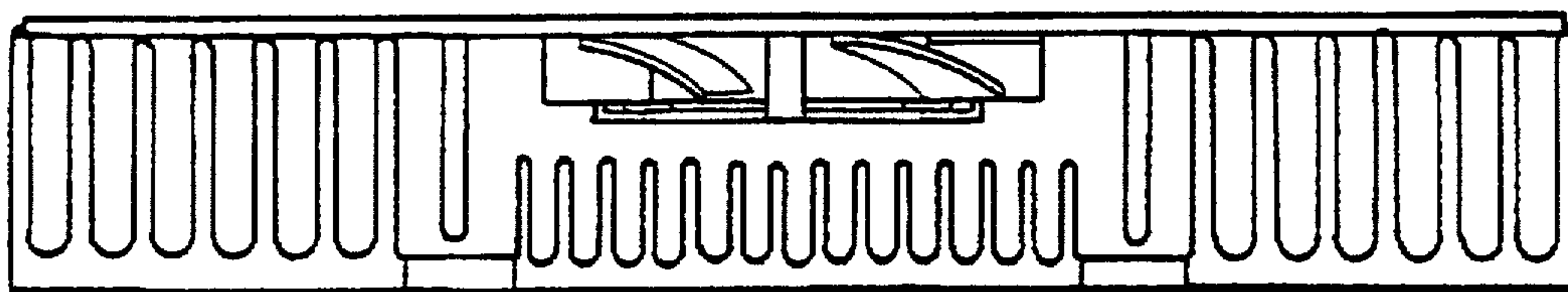

FIG. 6

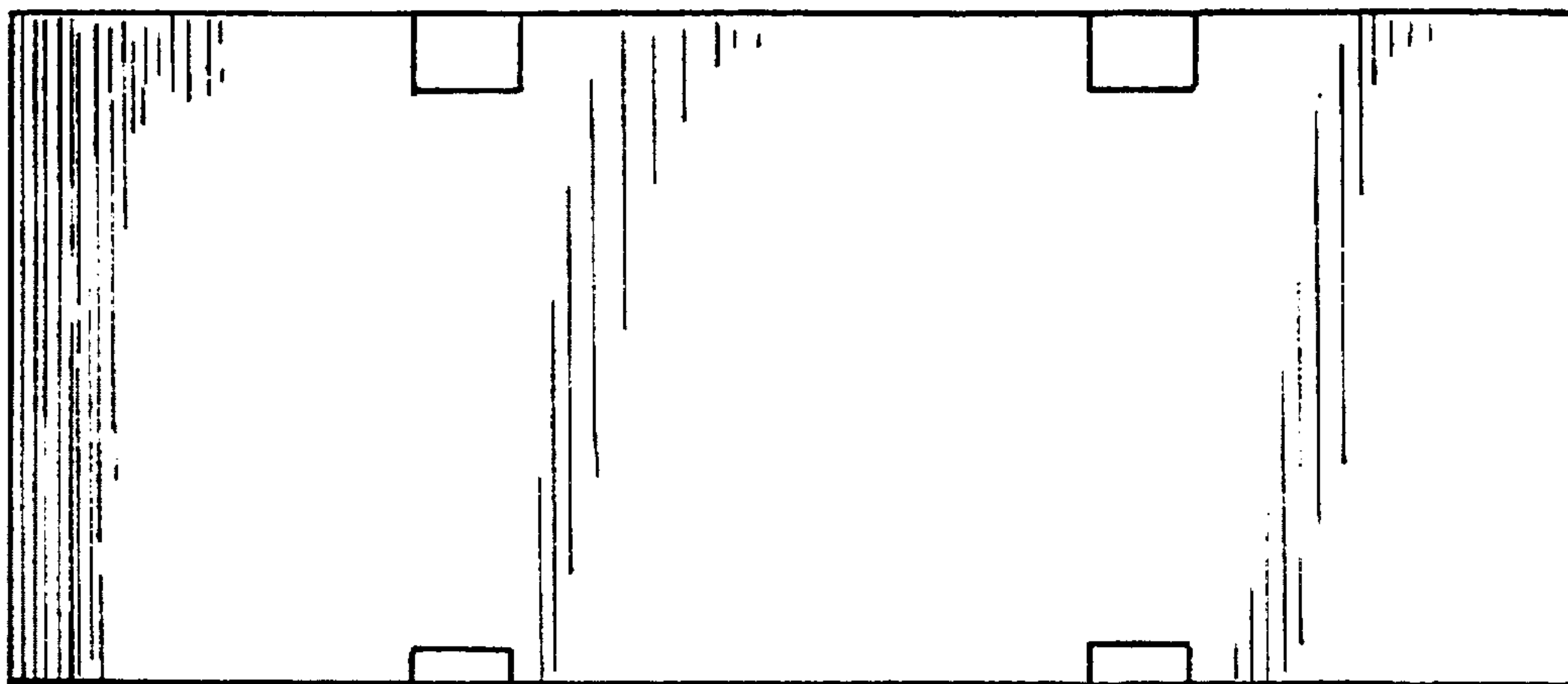

FIG. 7

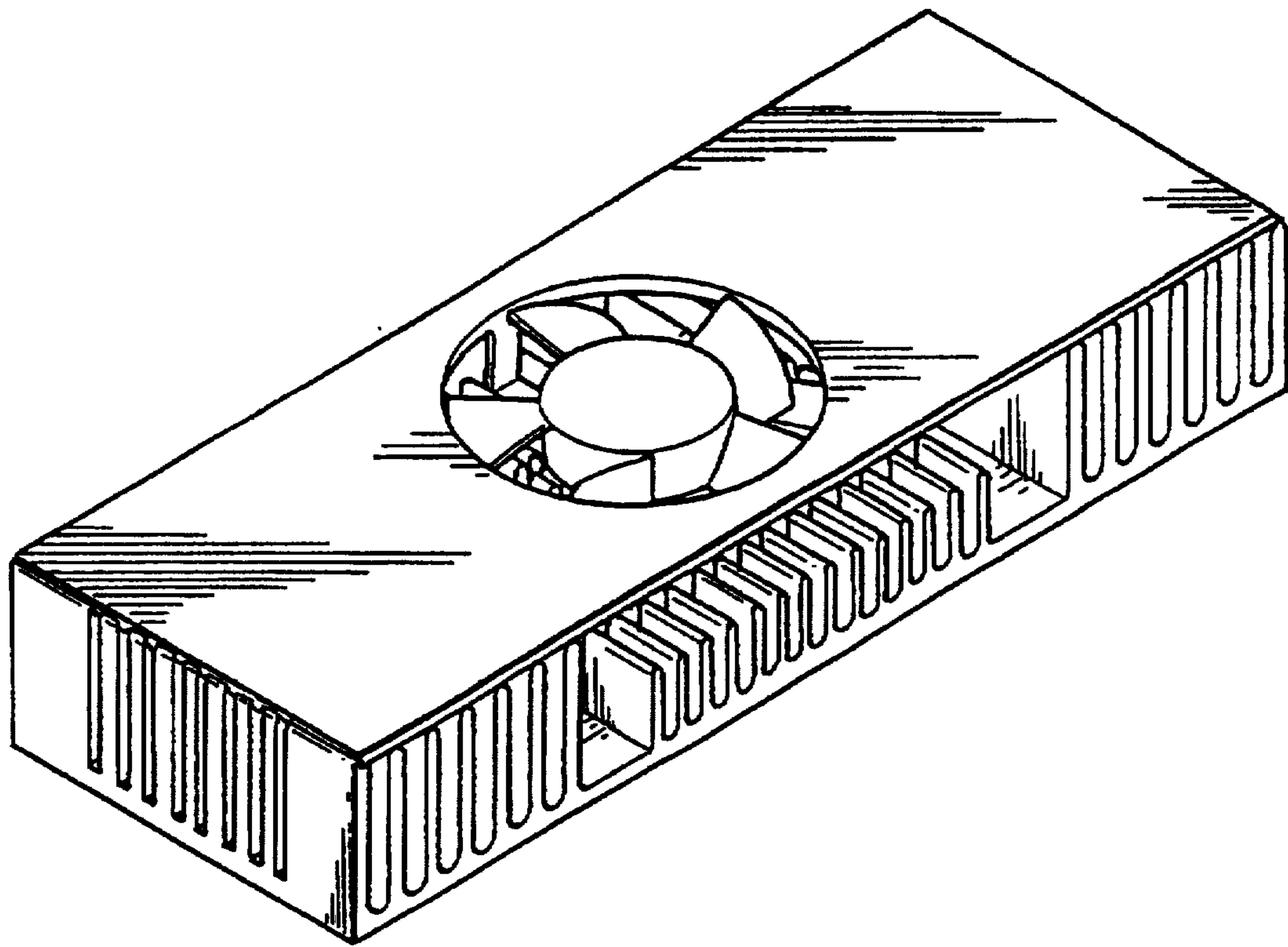

FIG.8

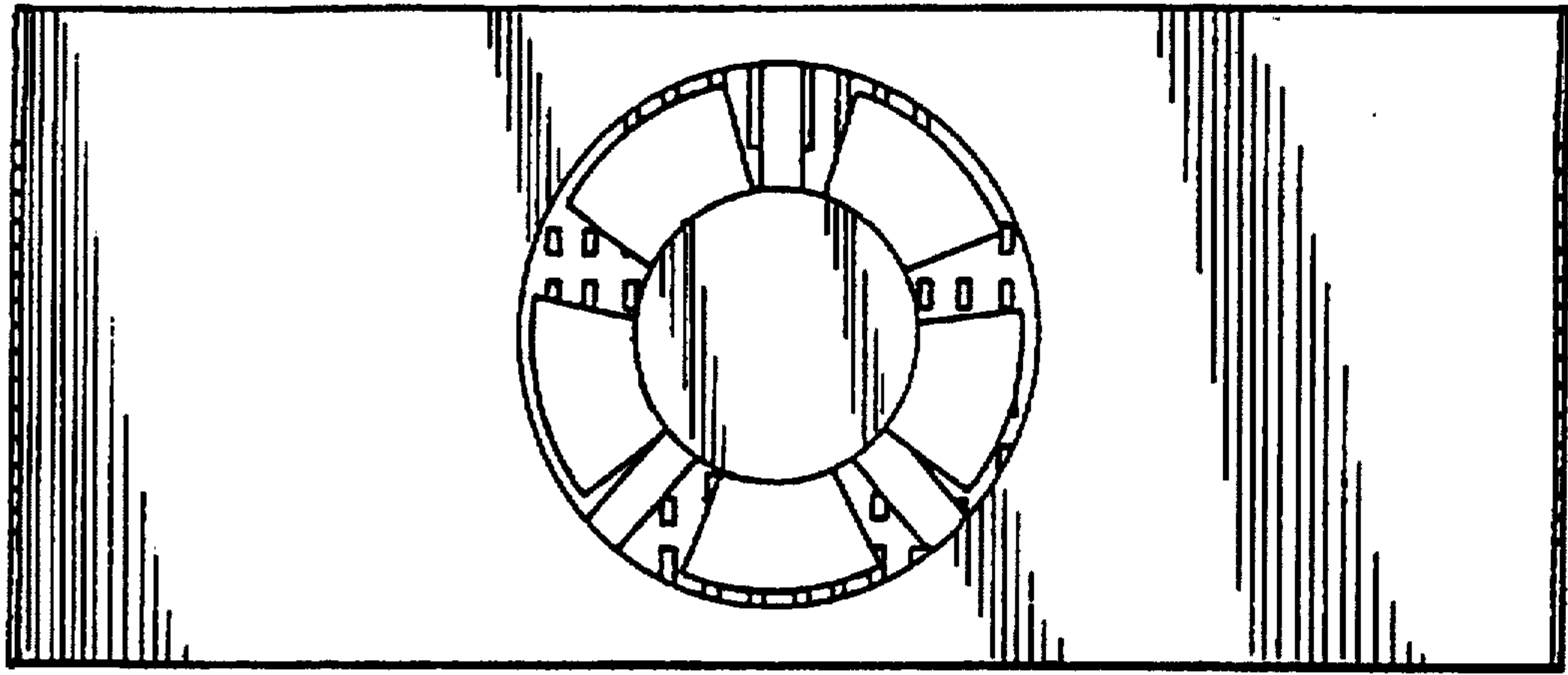

FIG. 9

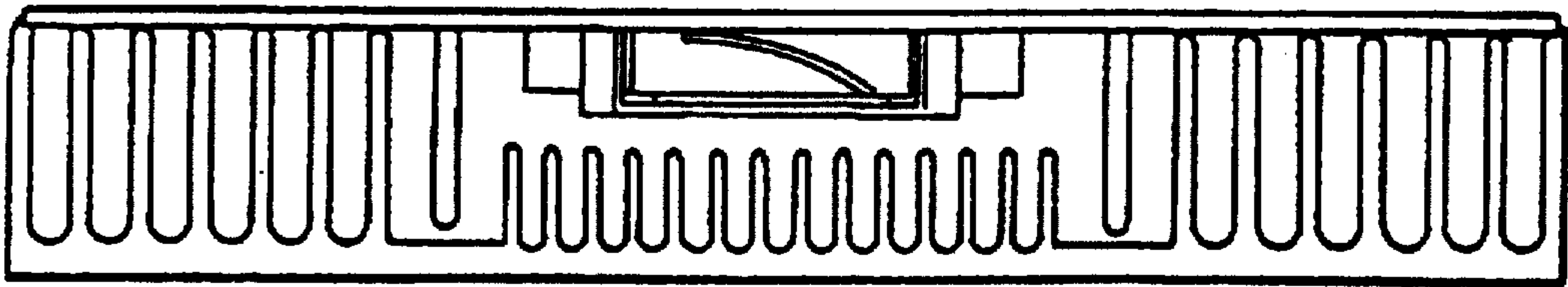

FIG. 10

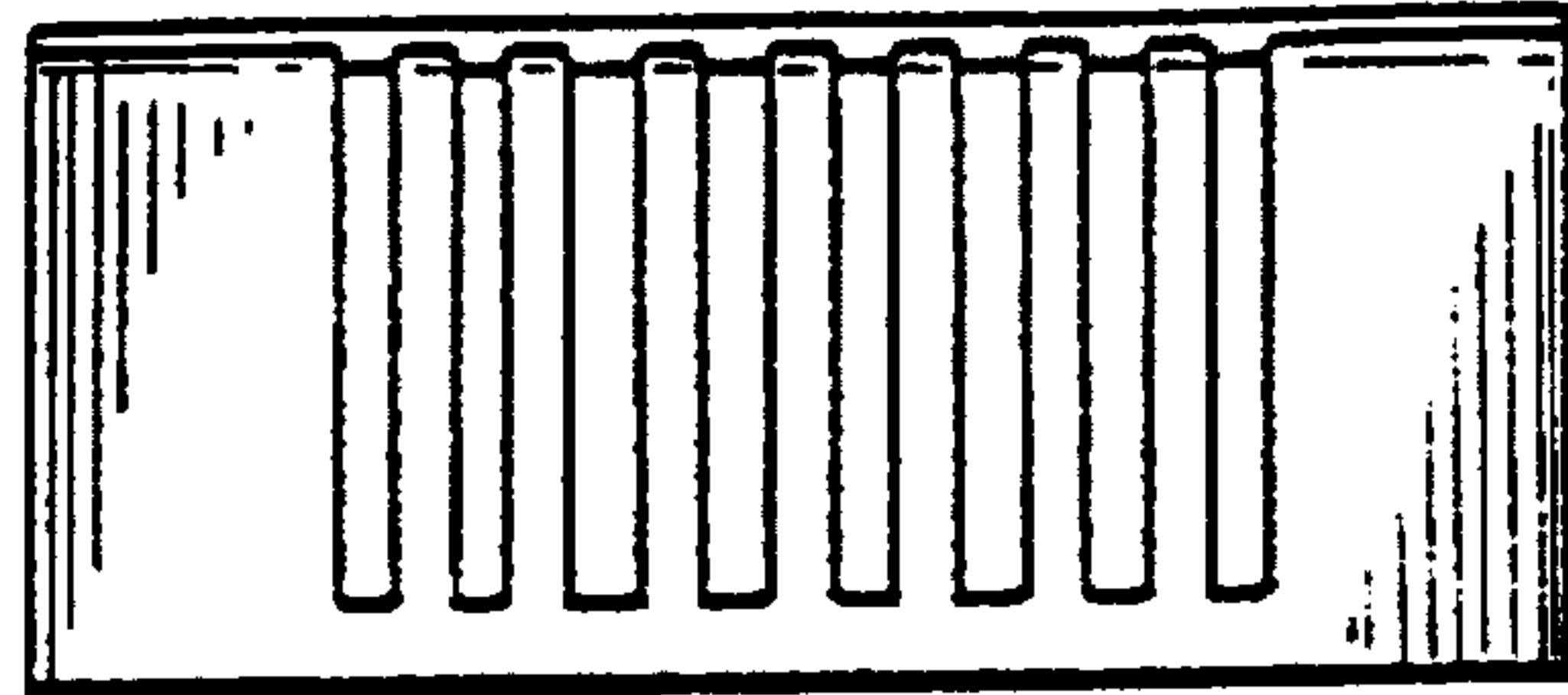

FIG. 11

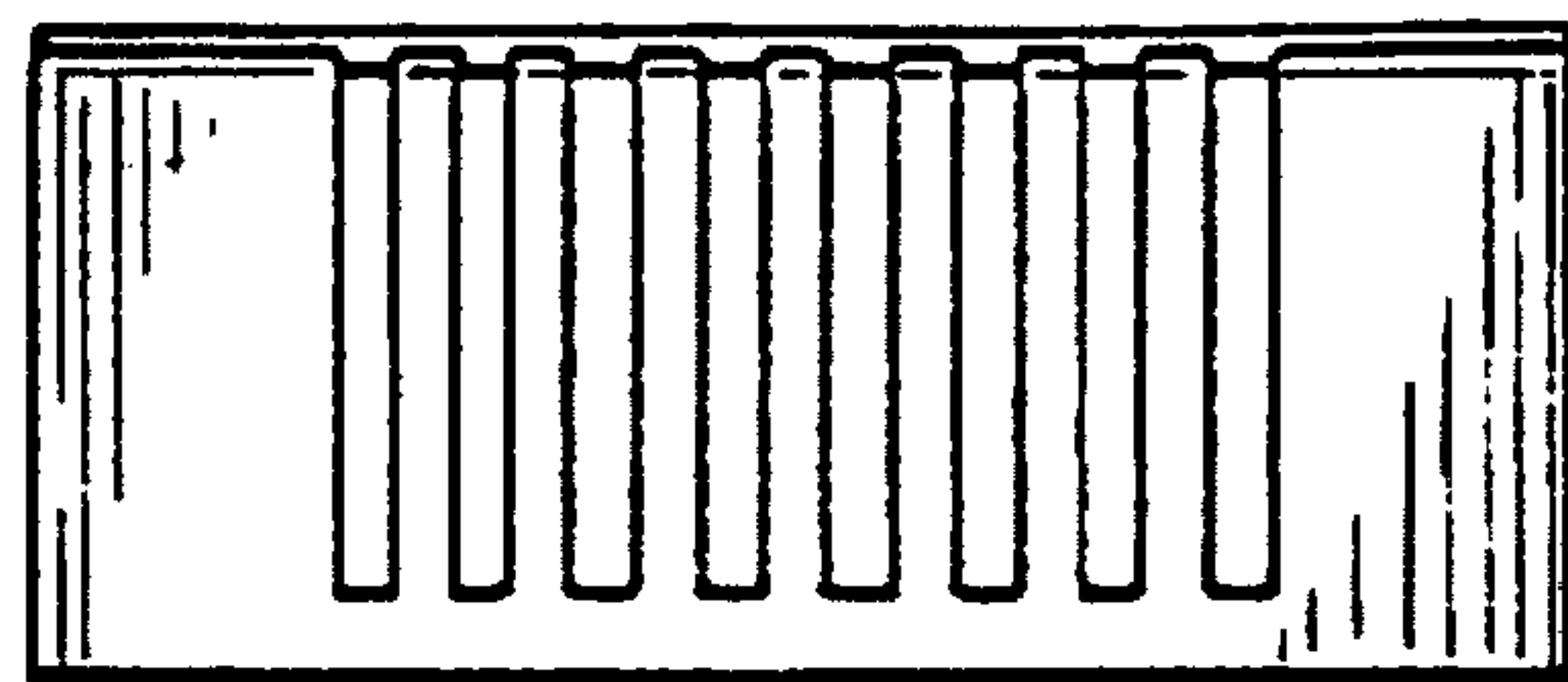

FIG. 12

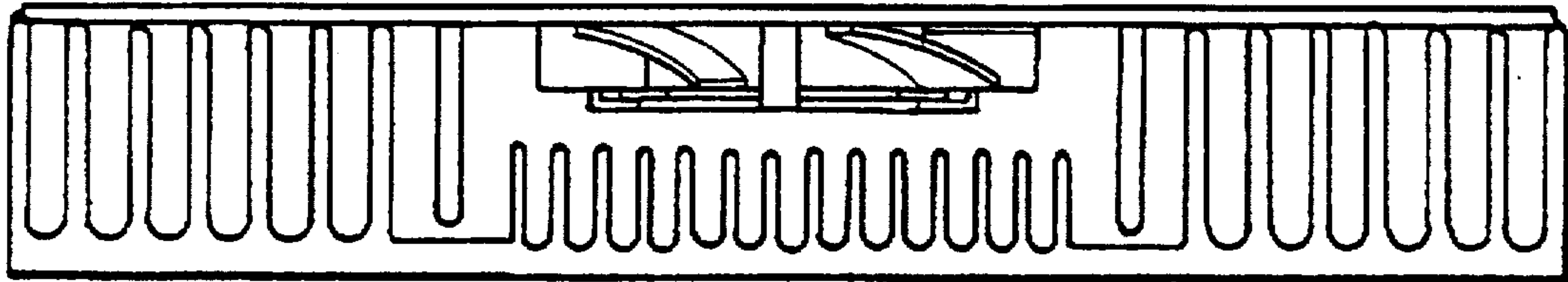

FIG. 13

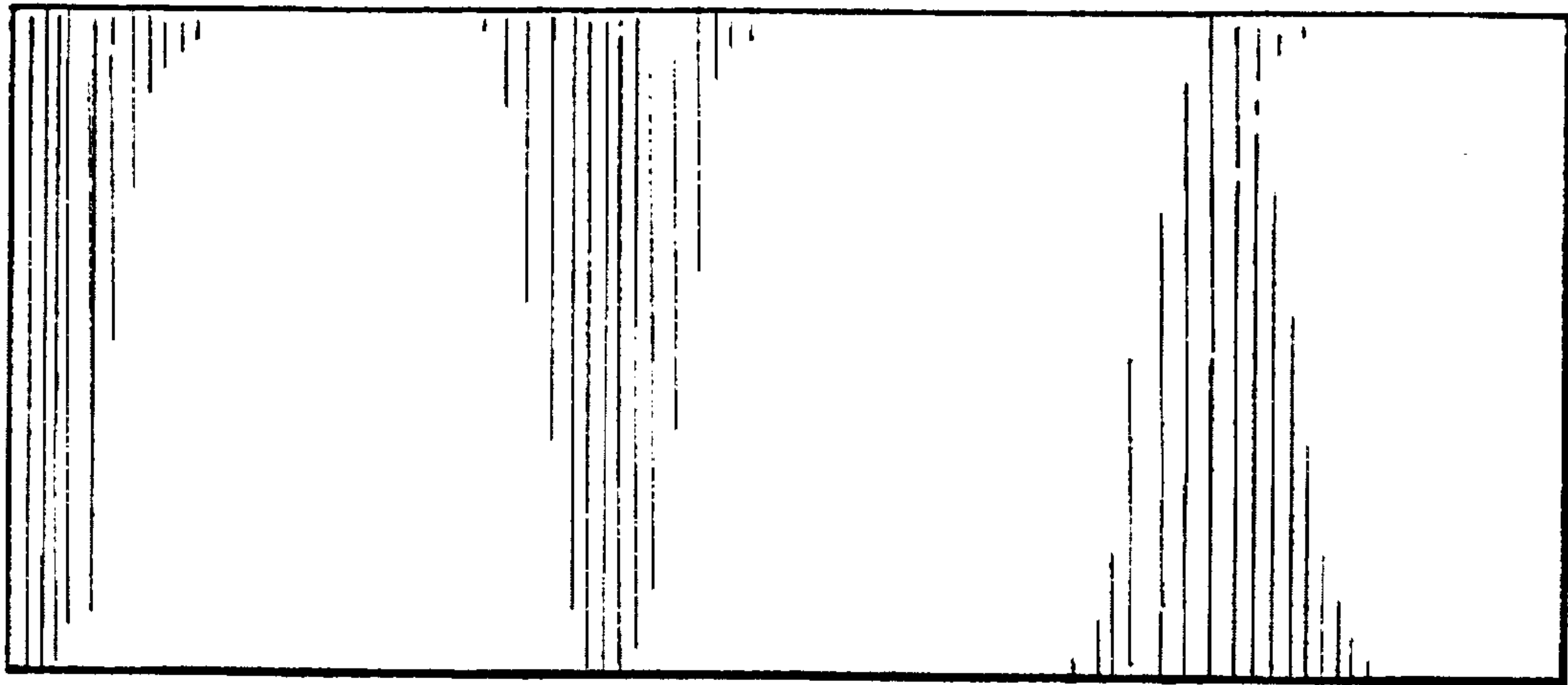

FIG. 14