



US00D408410S

**United States Patent** [19]  
**Zeitman**

[11] **Patent Number: Des. 408,410**  
[45] **Date of Patent: \*\*Apr. 20, 1999**

[54] **COMBINED RADIO AND CASSETTE  
PLAYER**

D. 383,459 9/1997 Zeitman ..... D14/163  
5,146,618 9/1992 Wenner ..... 455/347 X

[75] **Inventor: Josh Zeitman, Brooklyn, N.Y.**

*Primary Examiner*—Ted Shooman  
*Assistant Examiner*—Nanda Bondade  
*Attorney, Agent, or Firm*—Burns, Doane, Swecker &  
Mathis, L.L.P.

[73] **Assignee: Lennox Electronics Corp., N.Y.**

[\*\*] **Term: 14 Years**

[57] **CLAIM**

[21] **Appl. No.: 29/088,759**

The ornamental design for a combined radio and cassette  
player, as shown and described.

[22] **Filed: Jun. 1, 1998**

**DESCRIPTION**

[51] **LOC (6) CL ..... 14-01**

[52] **U.S. Cl. .... D14/162; D14/168**

[58] **Field of Search ..... D14/124, 160-165,  
D14/167-168, 188, 193-198; 455/344,  
347, 350, 351**

FIG. 1 is a perspective view of a combined radio and cassette  
player showing my designs;  
FIG. 2 is a front view thereof;  
FIG. 3 is a rear view thereof;  
FIG. 4 is a top plan view thereof;  
FIG. 5 is a bottom plan view thereof;  
FIG. 6 is a right side elevational view thereof; and,  
FIG. 7 is a left side elevational view thereof.

[56] **References Cited**

**U.S. PATENT DOCUMENTS**

D. 334,189 3/1993 Takimoto ..... D14/168 X  
D. 367,053 2/1996 Ogasawara et al. .... D14/163

**1 Claim, 6 Drawing Sheets**

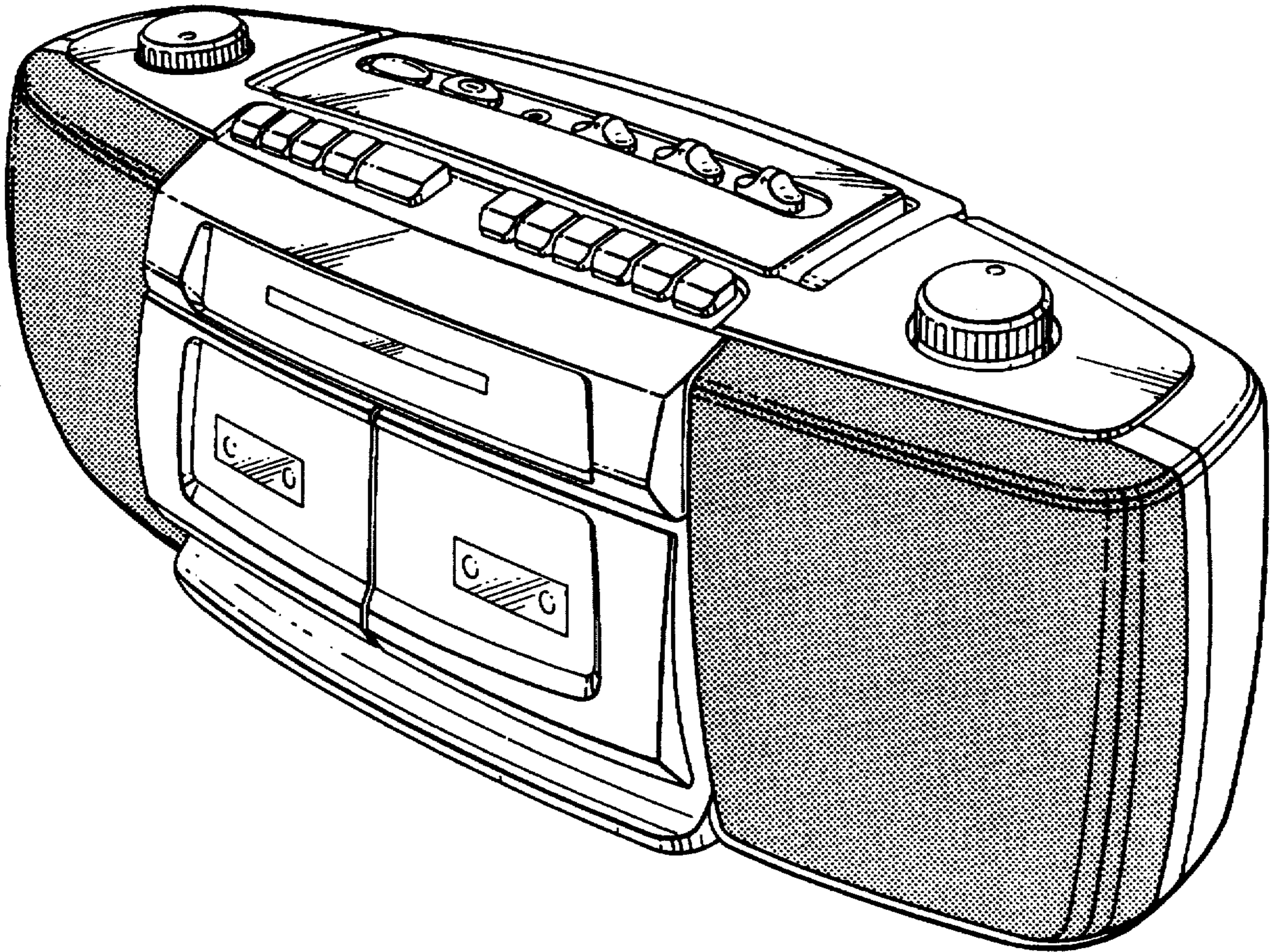

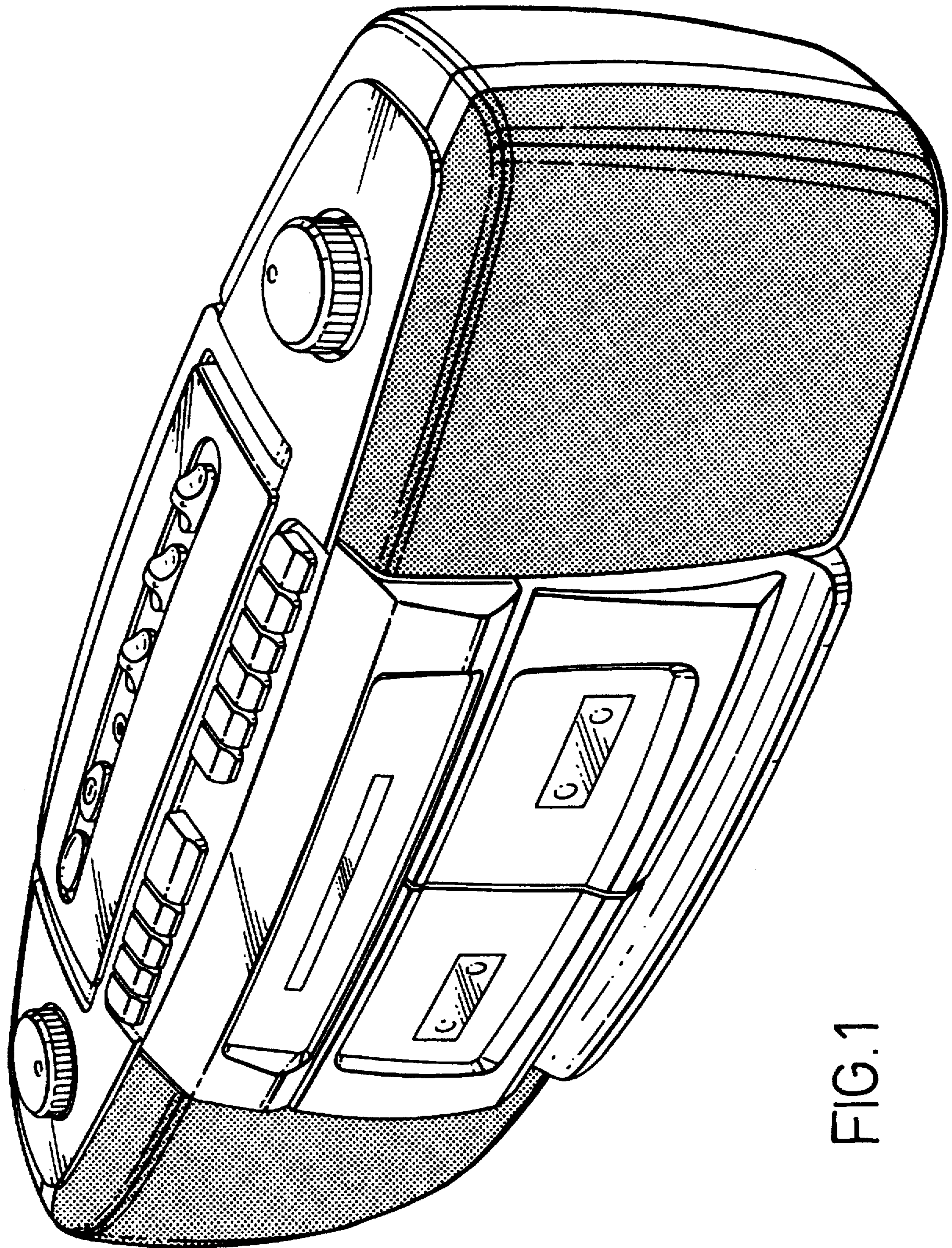

FIG. 1

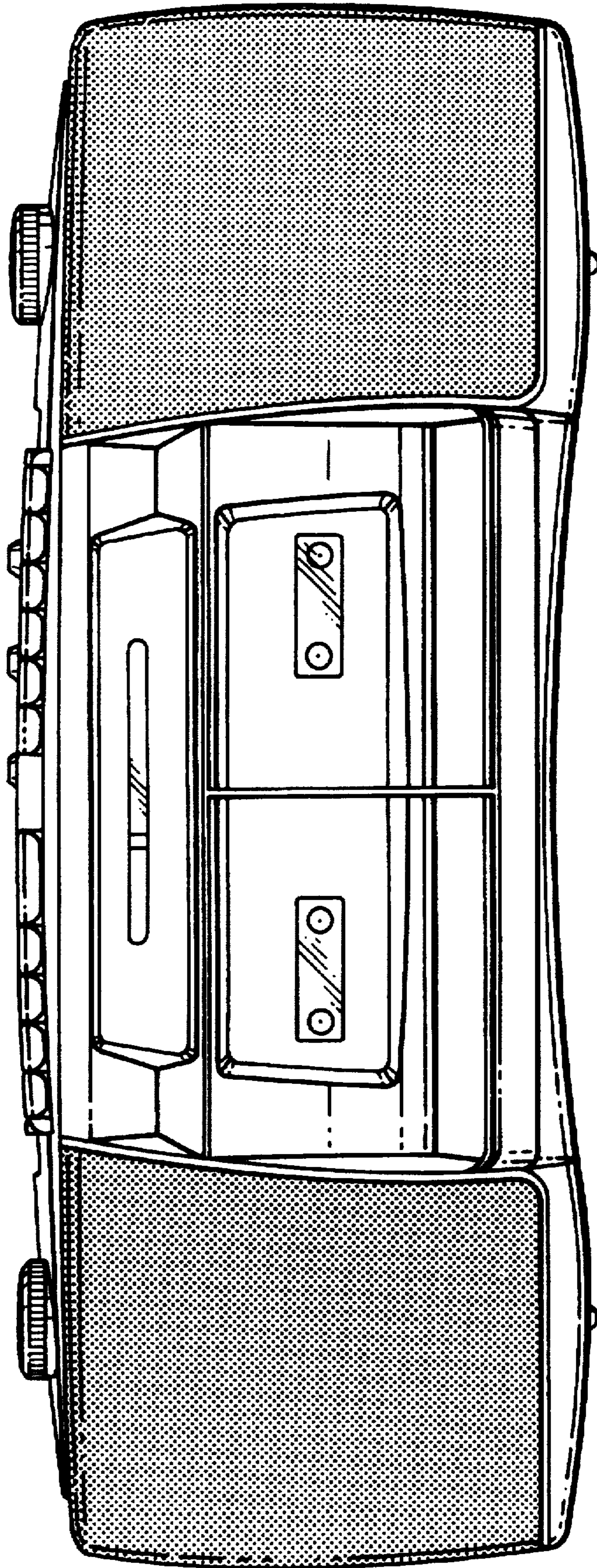

FIG. 2

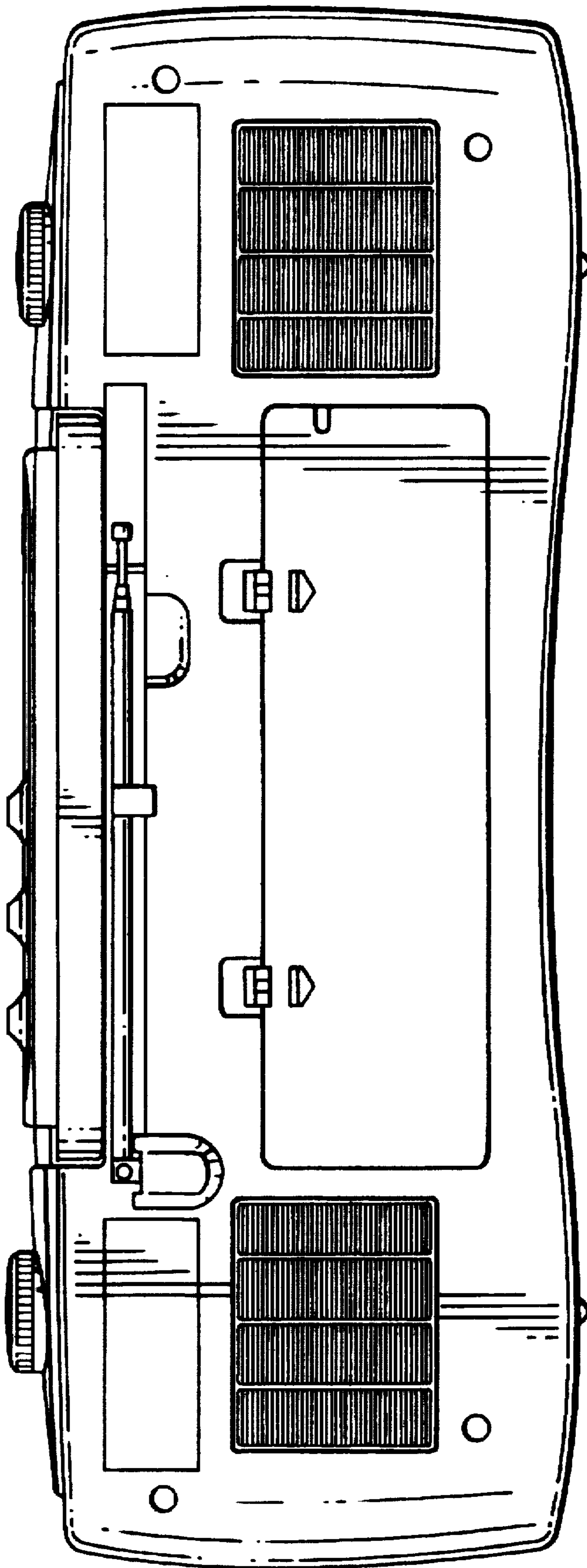

FIG. 3

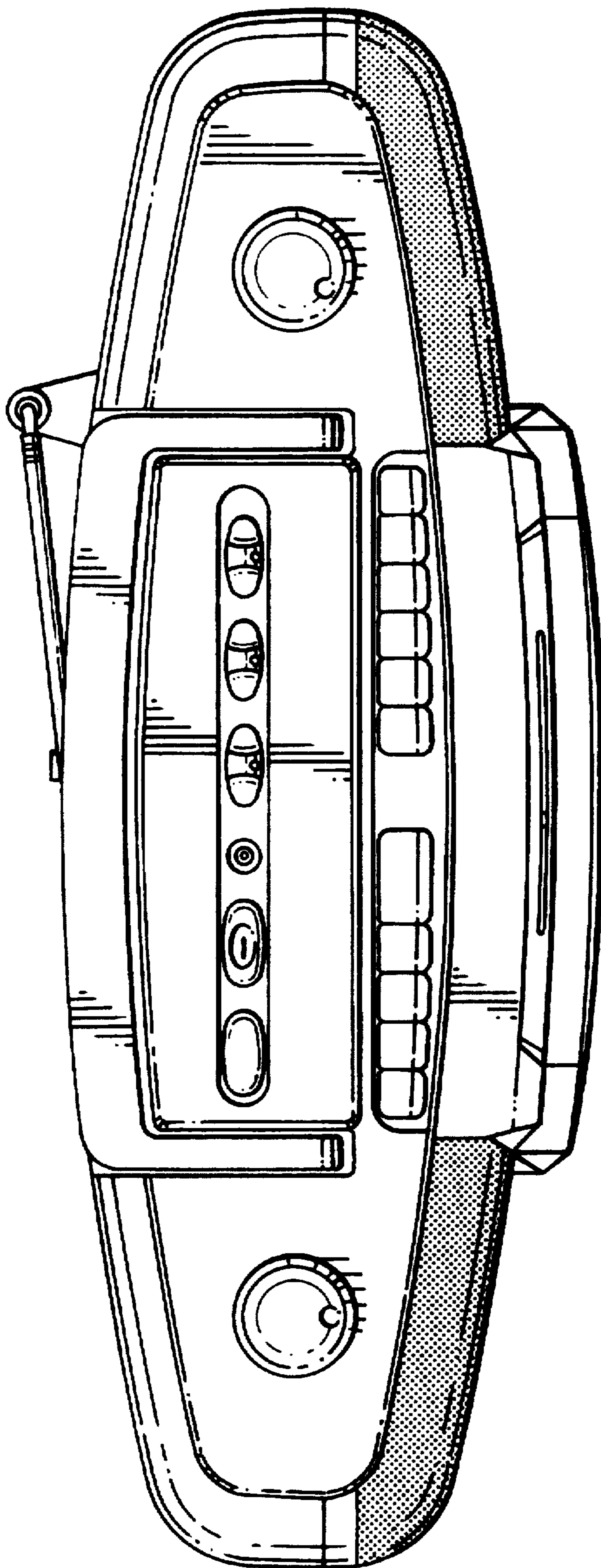

FIG. 4

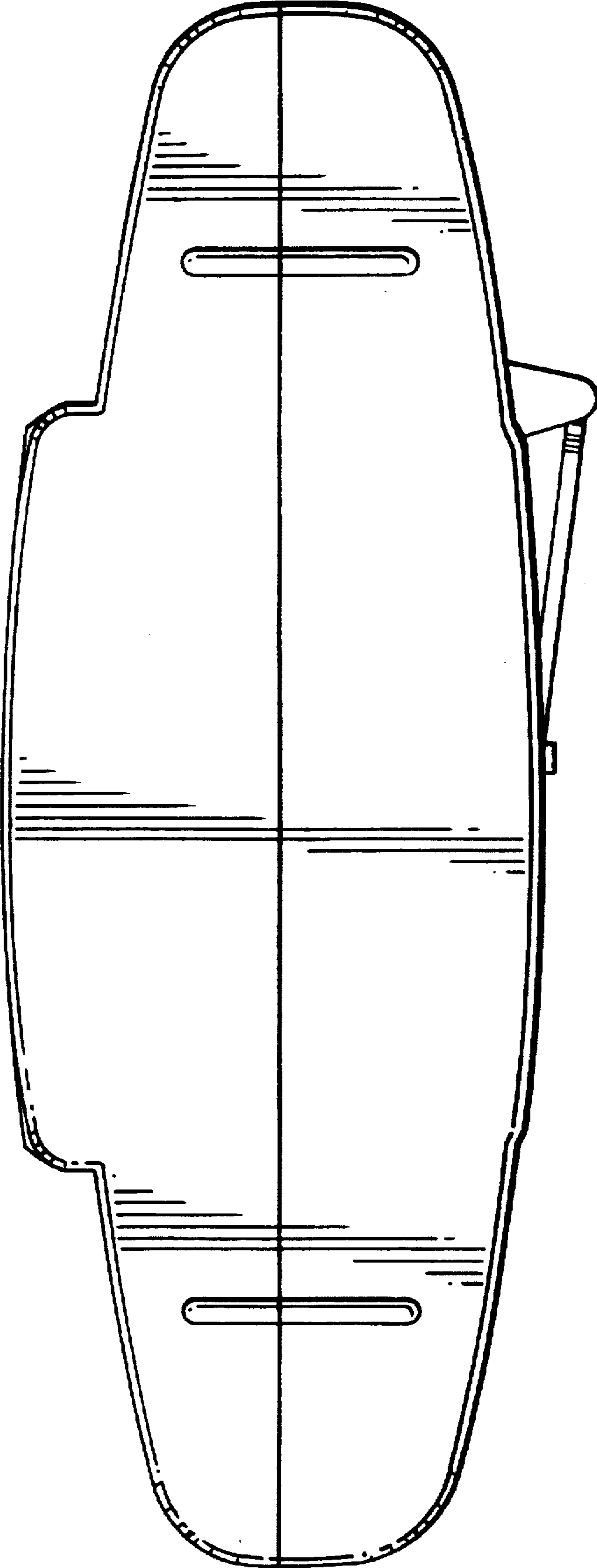

FIG. 5

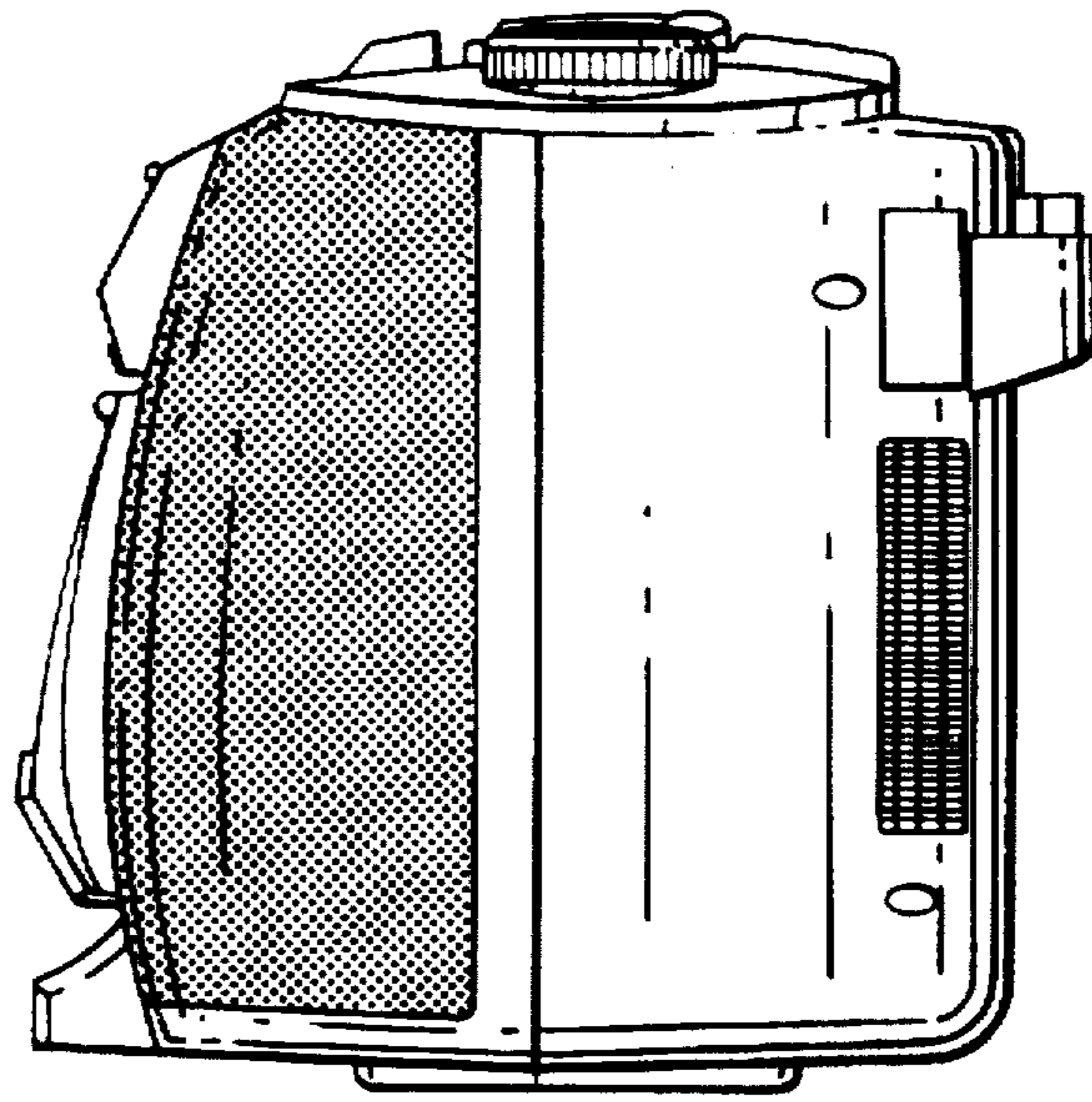

FIG. 6

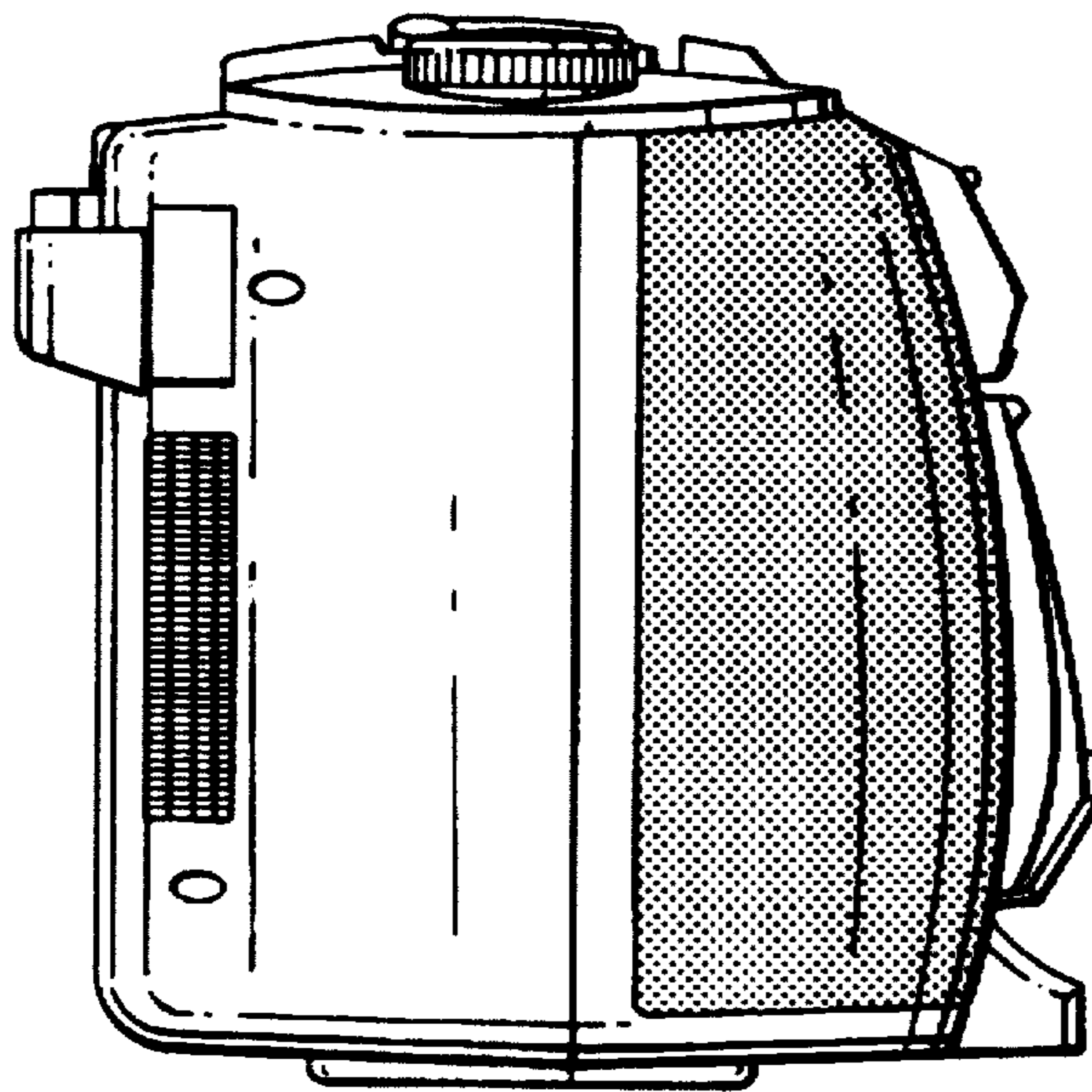

FIG. 7