

US00D408308S

United States Patent [19]
De Brecourt

[11] **Patent Number: Des. 408,308**
[45] **Date of Patent: **Apr. 20, 1999**

[54] **BED SCALE**

[76] **Inventor: Armande De Brecourt, 131-72
Laurelton Pkwy., Rosedale, N.Y. 11422**

[**] **Term: 14 Years**

[21] **Appl. No.: 29/092,138**

[22] **Filed: Aug. 13, 1998**

[51] **LOC (6) Cl. 10-04**

[52] **U.S. Cl. D10/87; D10/93; D10/94**

[58] **Field of Search D10/87, 93, 94;
177/144, 238-245**

[56] **References Cited**

U.S. PATENT DOCUMENTS

D. 395,020 6/1998 Reichow et al. D10/94
4,669,136 6/1987 Waters et al. 177/144 X

Primary Examiner—Antoine Duval Davis

[57] **CLAIM**

The ornamental design for a bed scale, as shown.

DESCRIPTION

FIG. 1 is a top plan view of the bed scale of the present invention;

FIG. 2 is a bottom plan view of the bed scale of FIG. 1;

FIG. 3 is a right side elevational view of the bed scale of FIG. 1;

FIG. 4 is a left side elevational view of the bed scale of FIG. 1;

FIG. 5 is a front elevational view of the bed scale of FIG. 1;

FIG. 6 is a back elevational view of the bed scale of FIG. 1; and,

FIG. 7 is a top, front, right side perspective view of the bed scale of FIG. 1.
The broken line showing is for illustrative purposes only and forms no part of the claimed design.

1 Claim, 3 Drawing Sheets

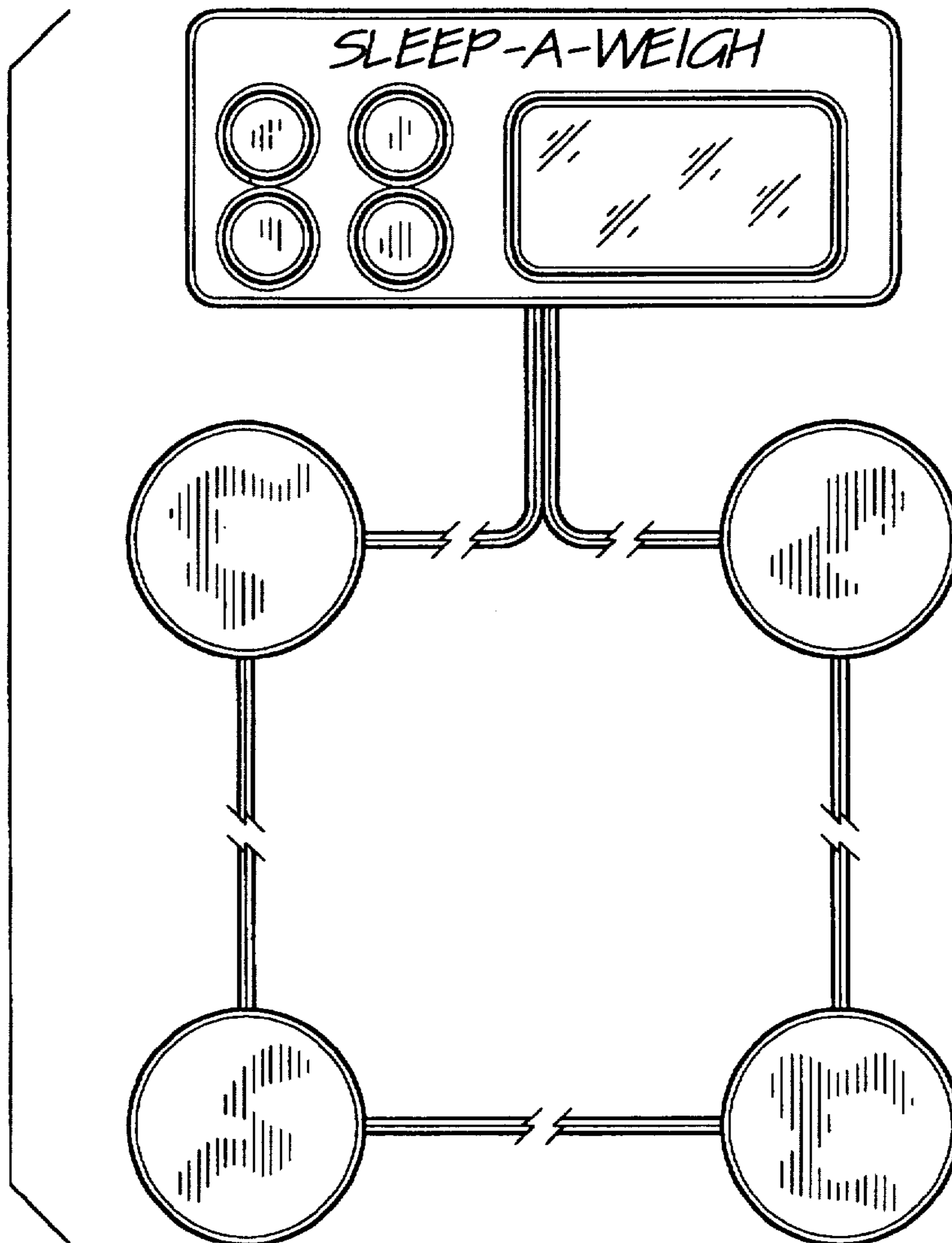

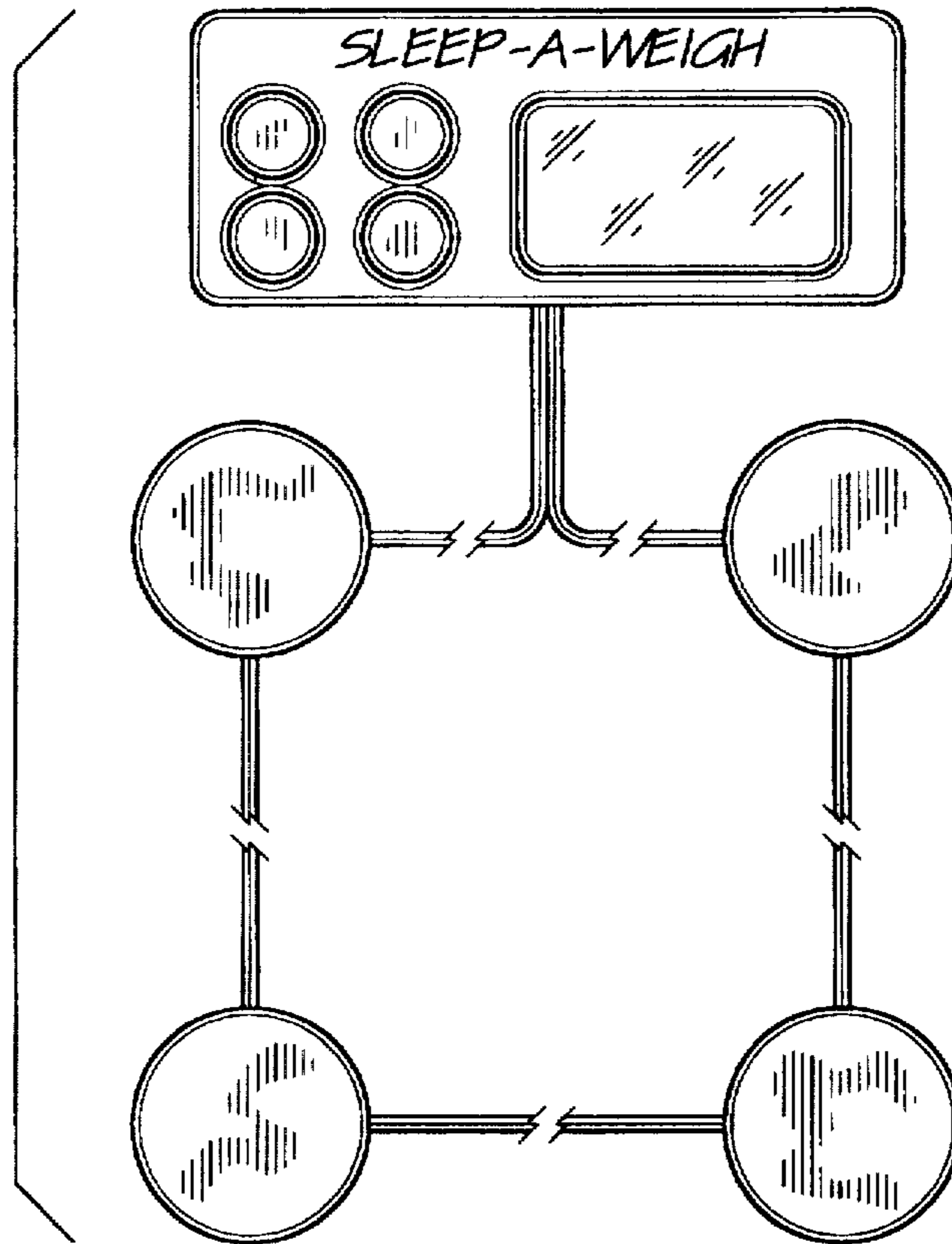

Fig. 1

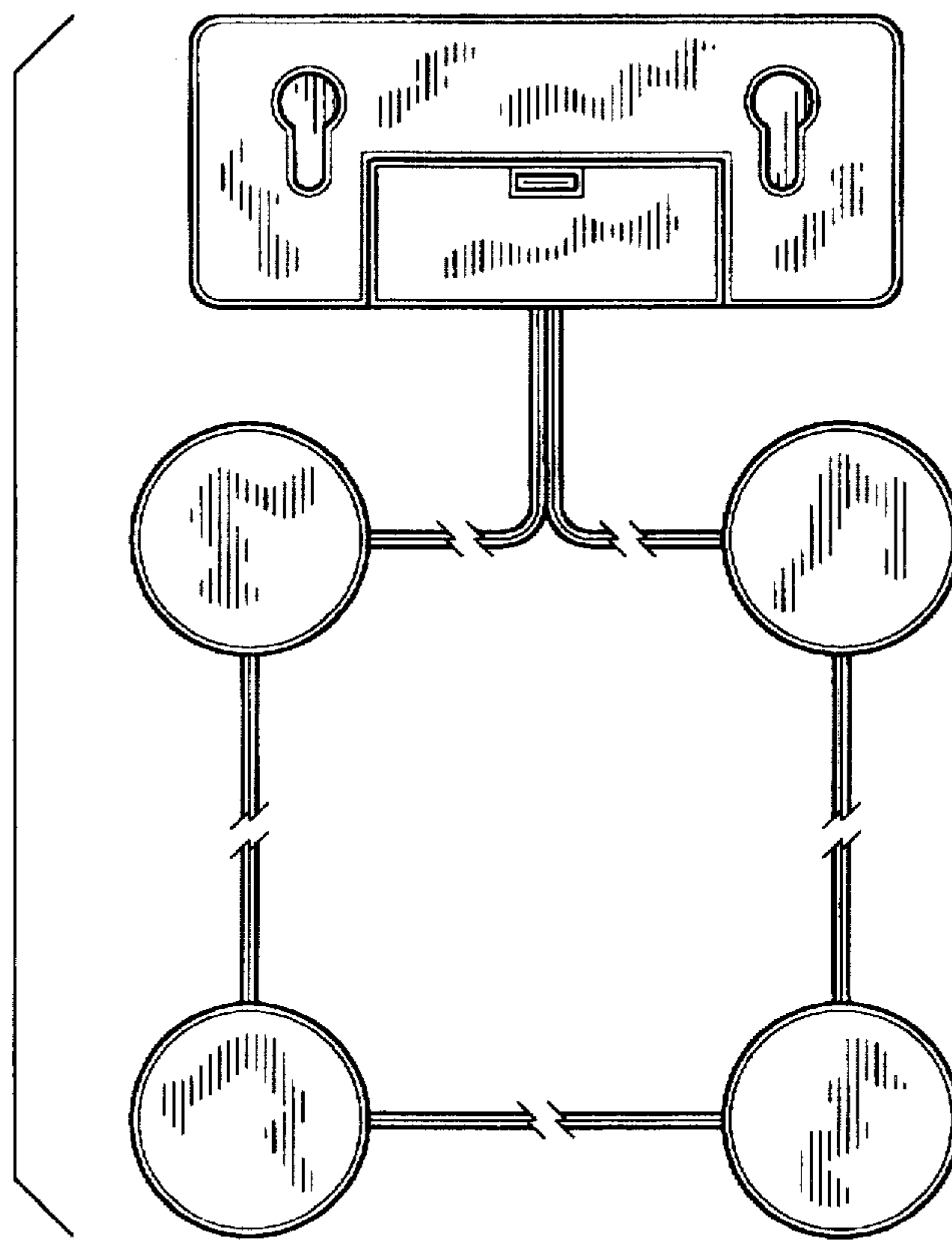

Fig. 2

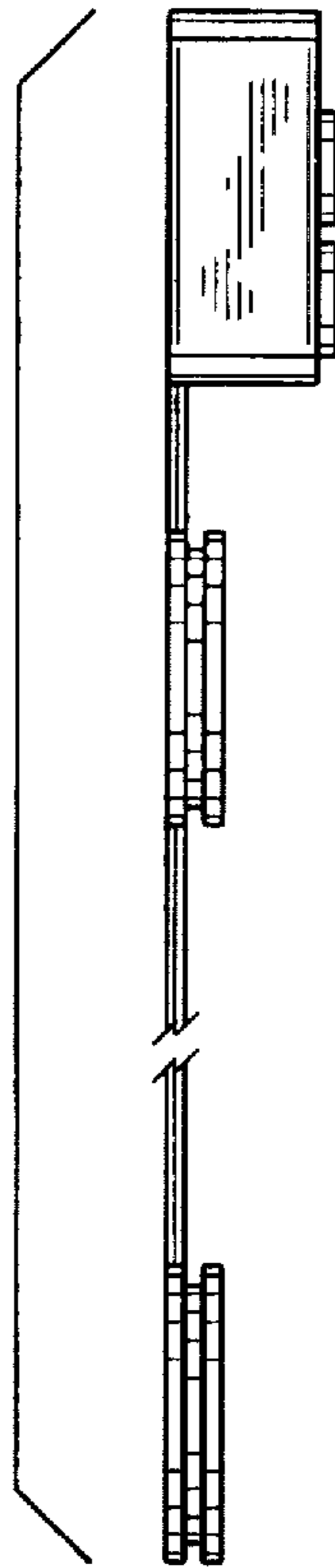

Fig. 3

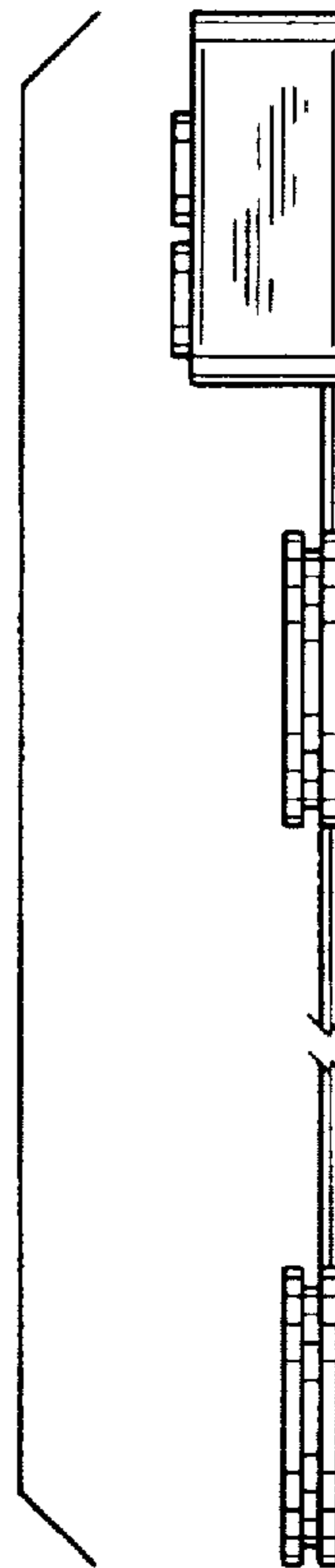

Fig. 4



Fig. 5

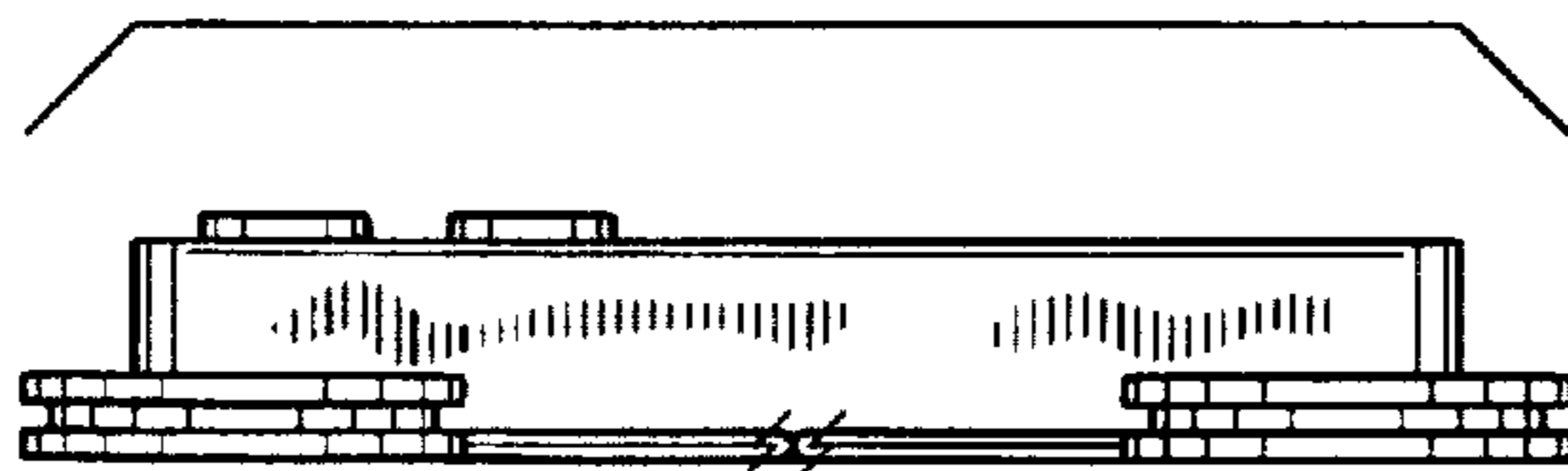

Fig. 6

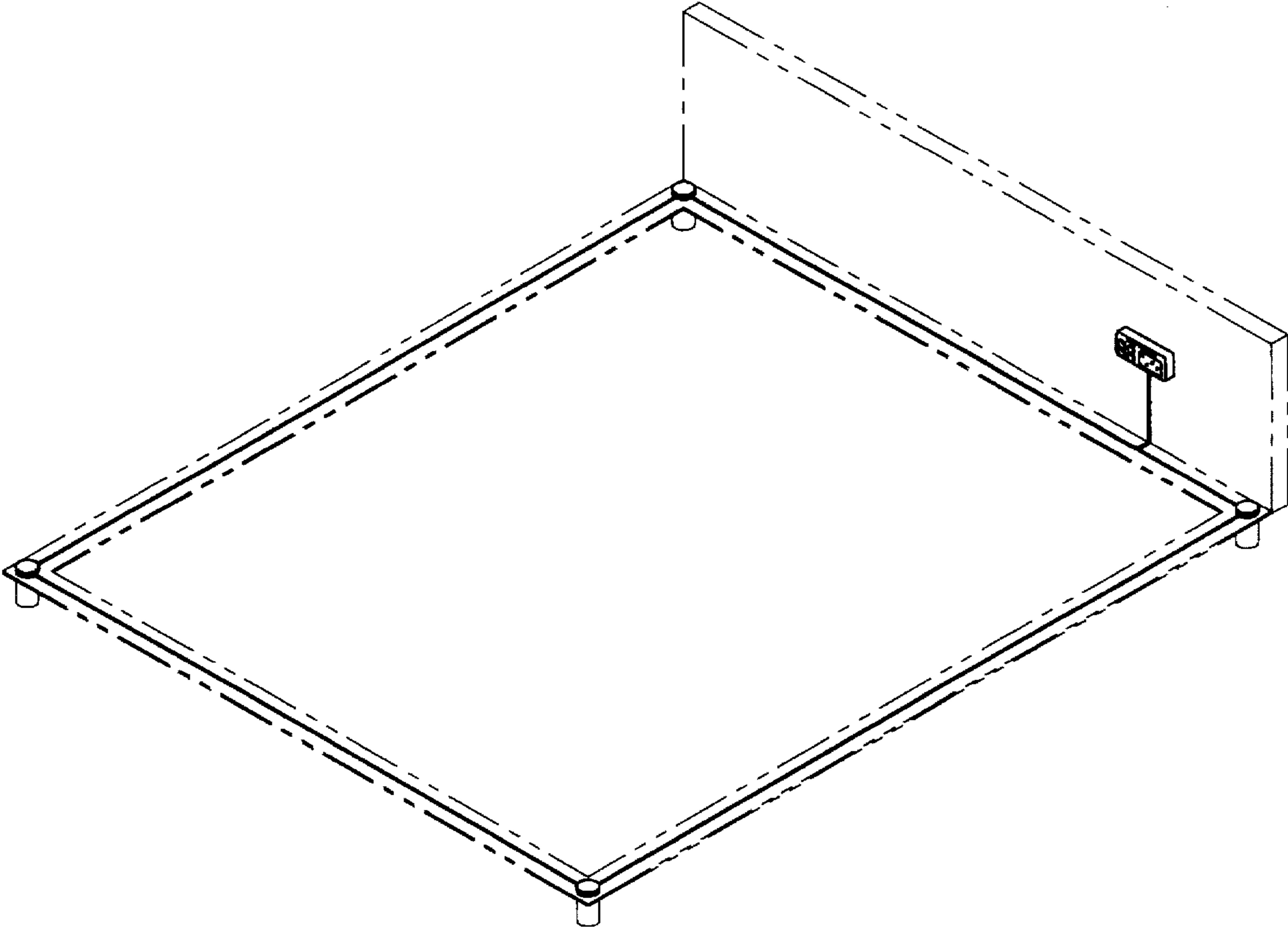

Fig. 7