



US00D408222S

# United States Patent [19]

Carter

[11] Patent Number: Des. 408,222

[45] Date of Patent: \*\*Apr. 20, 1999

[54] DIVIDED BAKING DISH

[76] Inventor: **Jacqueline W. Carter**, 4230 S. Raymond Rd., Waterloo, Iowa 50701

[\*\*] Term: 14 Years

[21] Appl. No.: 29/090,028

[22] Filed: Jun. 29, 1998

[51] LOC (6) CL ..... 07-01

[52] U.S. CL ..... D7/541; D7/542; D7/543; D7/546; D7/553.3; D7/549

[58] Field of Search ..... D7/549, 538, 541, D7/542, 543, 545, 546, 548, 360, 354, 357, 553.2, 553.3; 206/564; 270/575, 23.8, 555, 792, 543

### [56] References Cited

#### U.S. PATENT DOCUMENTS

D. 87,203	6/1932	Clark	.....	D7/543
D. 209,769	1/1968	Bateman et al.	.....	D7/546
D. 212,821	11/1968	Benes	.....	D7/543
D. 224,554	8/1972	Swett	.....	D7/541
D. 224,662	8/1972	Swett et al.	.....	D7/546

D. 270,703	9/1983	El-Hag et al.	.....	D7/354 X
D. 284,727	7/1986	Gerber	.....	D7/546
D. 319,165	8/1991	Gecchlin	.....	D7/545 X
D. 326,797	6/1992	Pomroy et al.	.....	D7/354 X
D. 340,614	10/1993	Kaeding	.....	D7/354 X
2,663,449	12/1953	Smart	.....	D7/543
4,976,370	12/1990	Cassel	.....	220/792

Primary Examiner—M. N. Pandozzi

### [57] CLAIM

The ornamental design for a divided baking dish, as shown and described.

### DESCRIPTION

FIG. 1 is a front elevational view of the divided baking dish showing my new design;  
 FIG. 2 is a rear elevational view thereof;  
 FIG. 3 is a left side elevational view thereof;  
 FIG. 4 is a right side elevational view thereof;  
 FIG. 5 is a top plan view thereof;  
 FIG. 6 is a bottom plan view thereof; and,  
 FIG. 7 is an exploded perspective view thereof.  
 The broken lines in FIGS. 5 and 7 are for illustrative purposes only and forms no part of the claimed design.

1 Claim, 4 Drawing Sheets

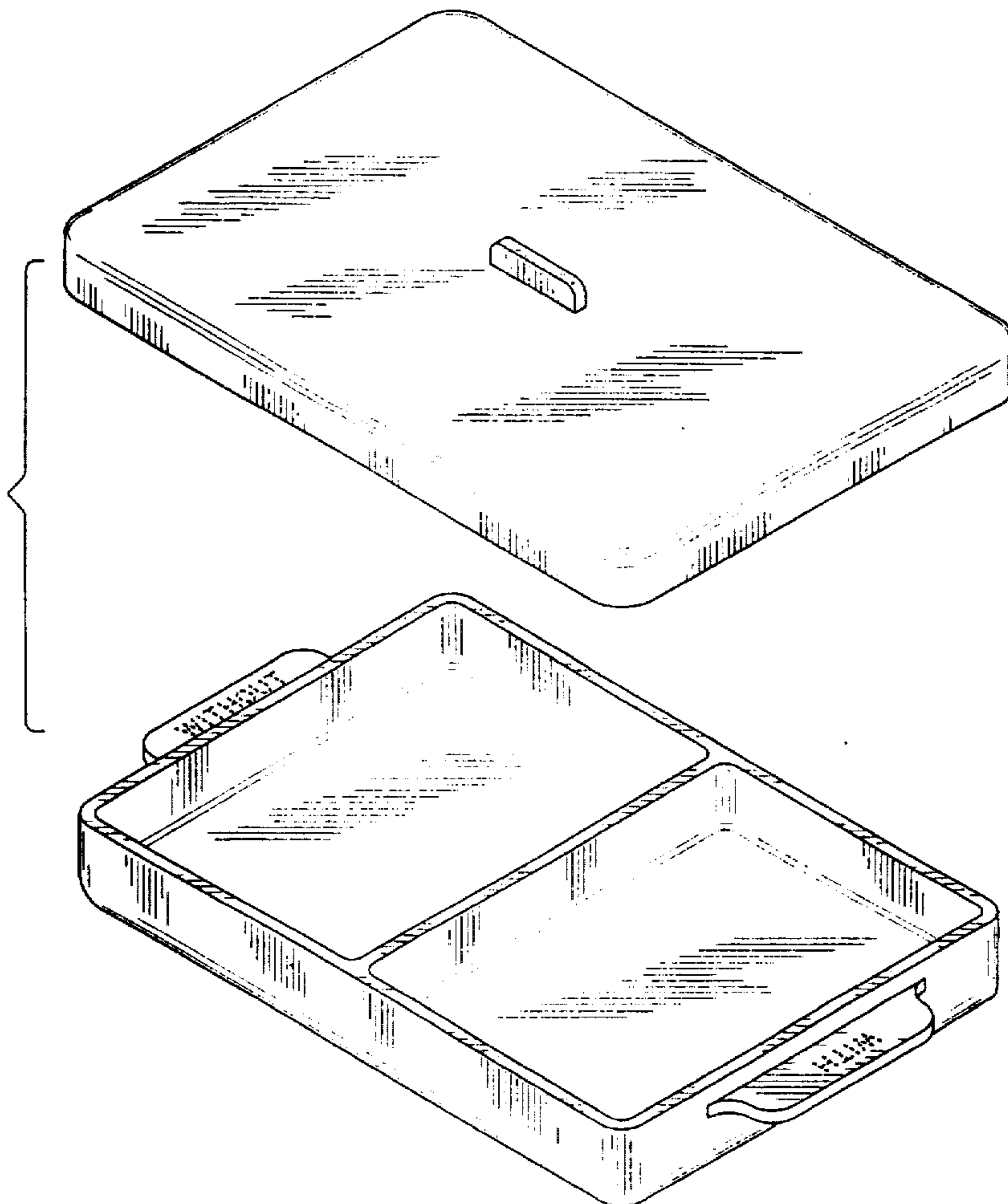

FIG. 1

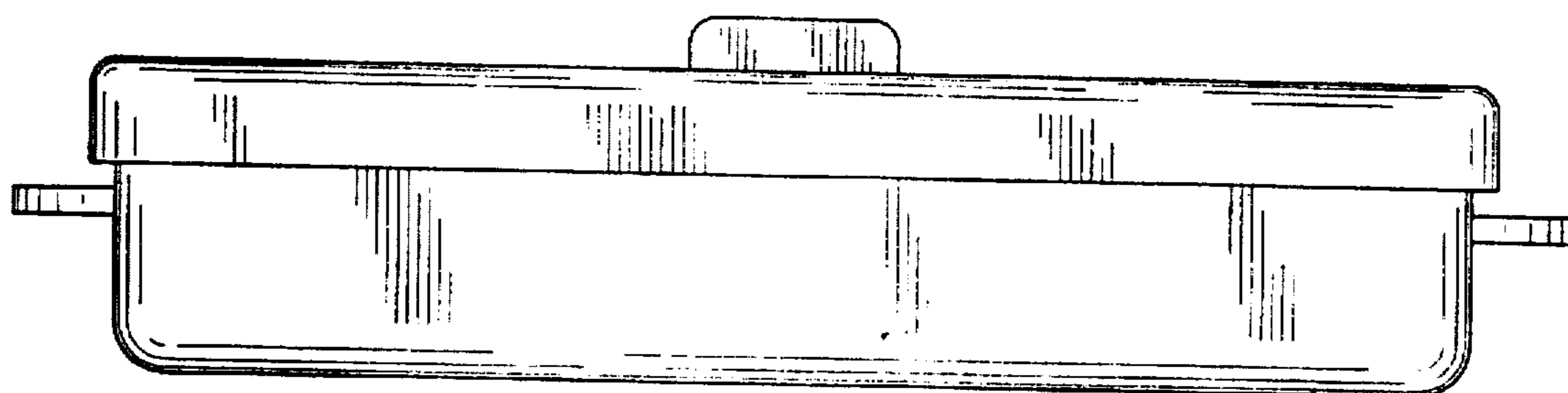

FIG. 2

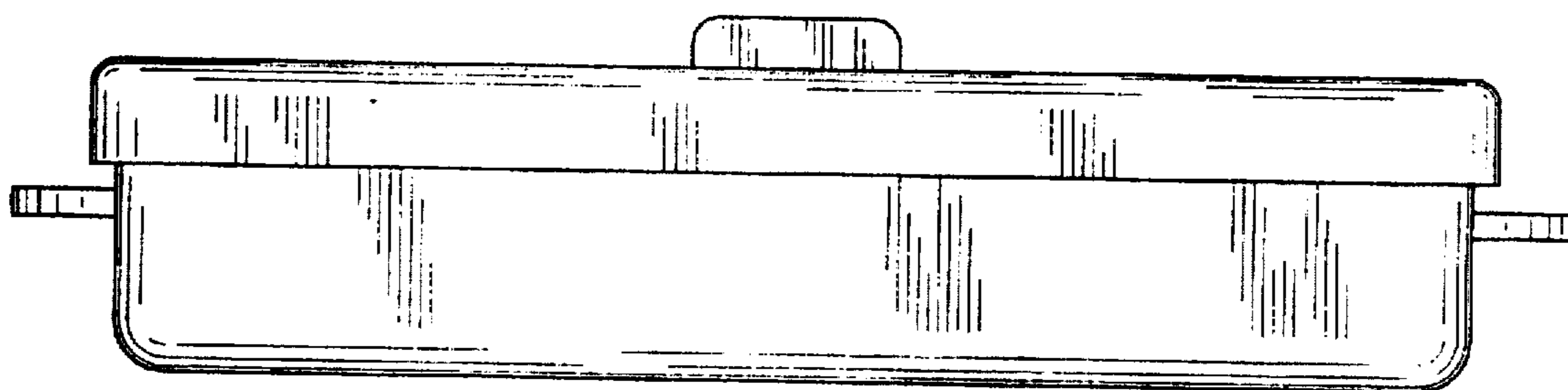

FIG. 3

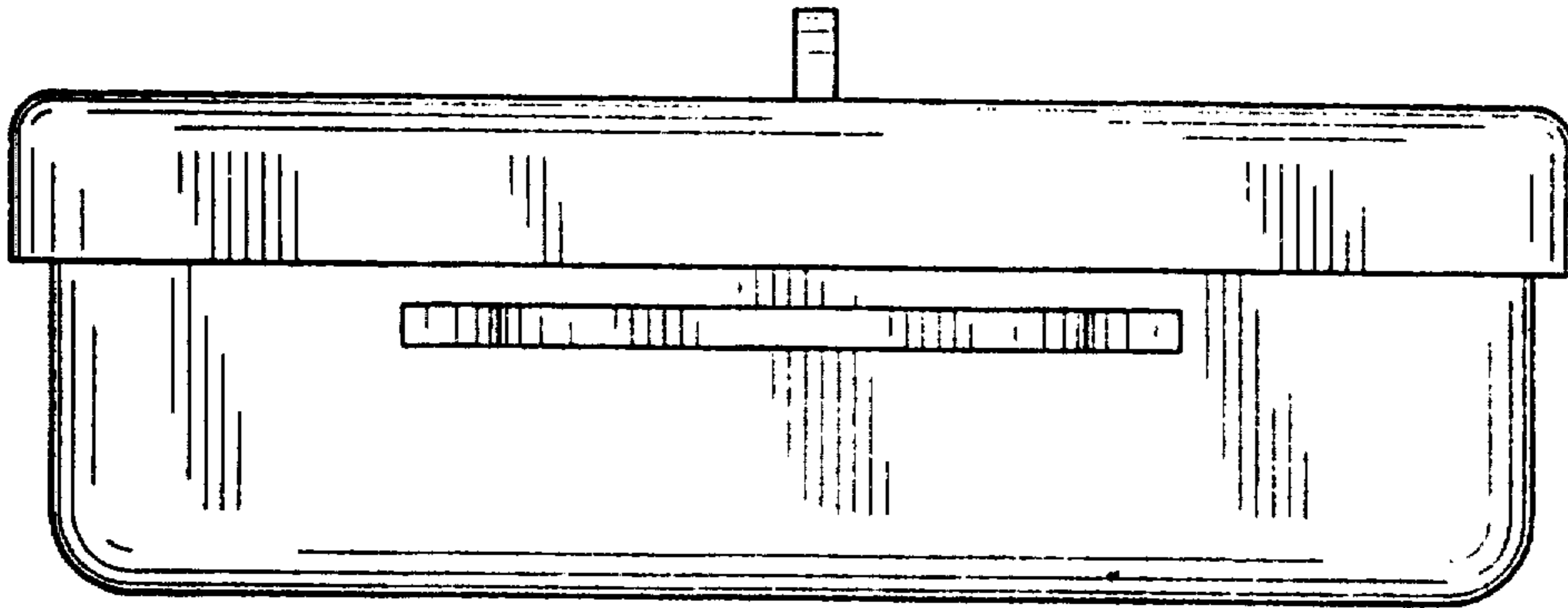

FIG. 4

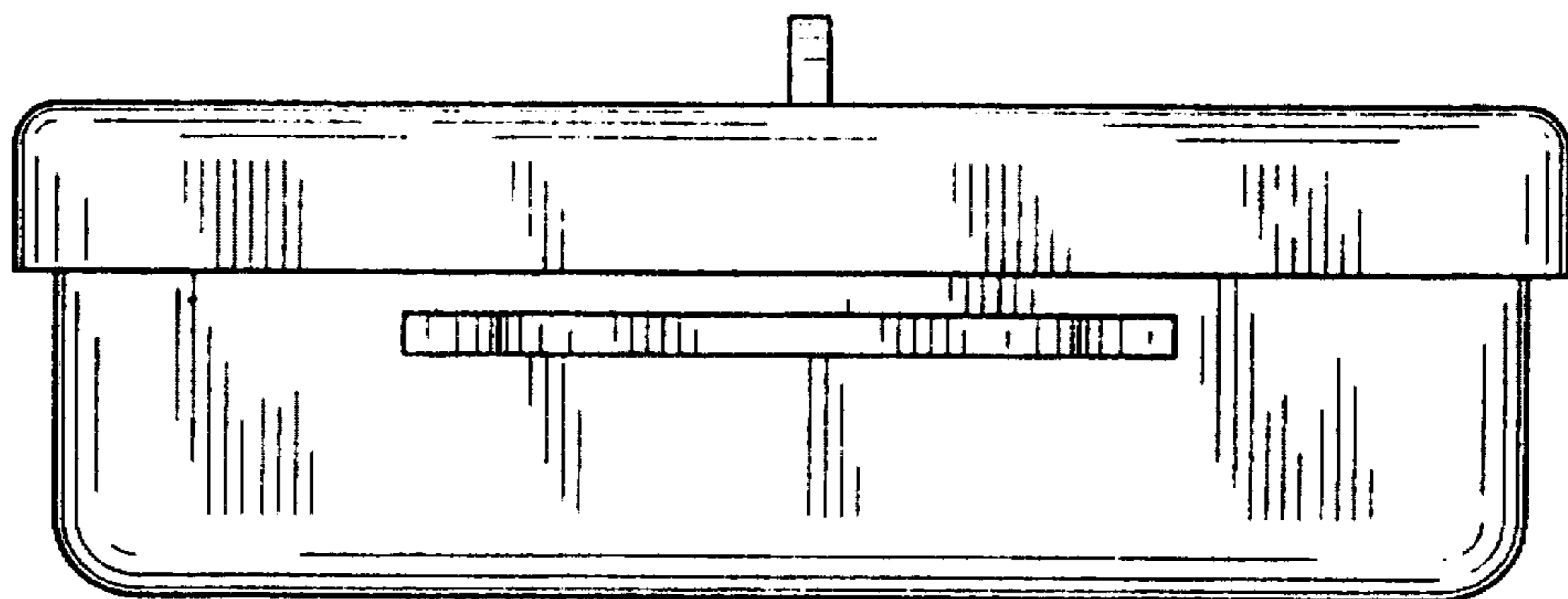

FIG. 5

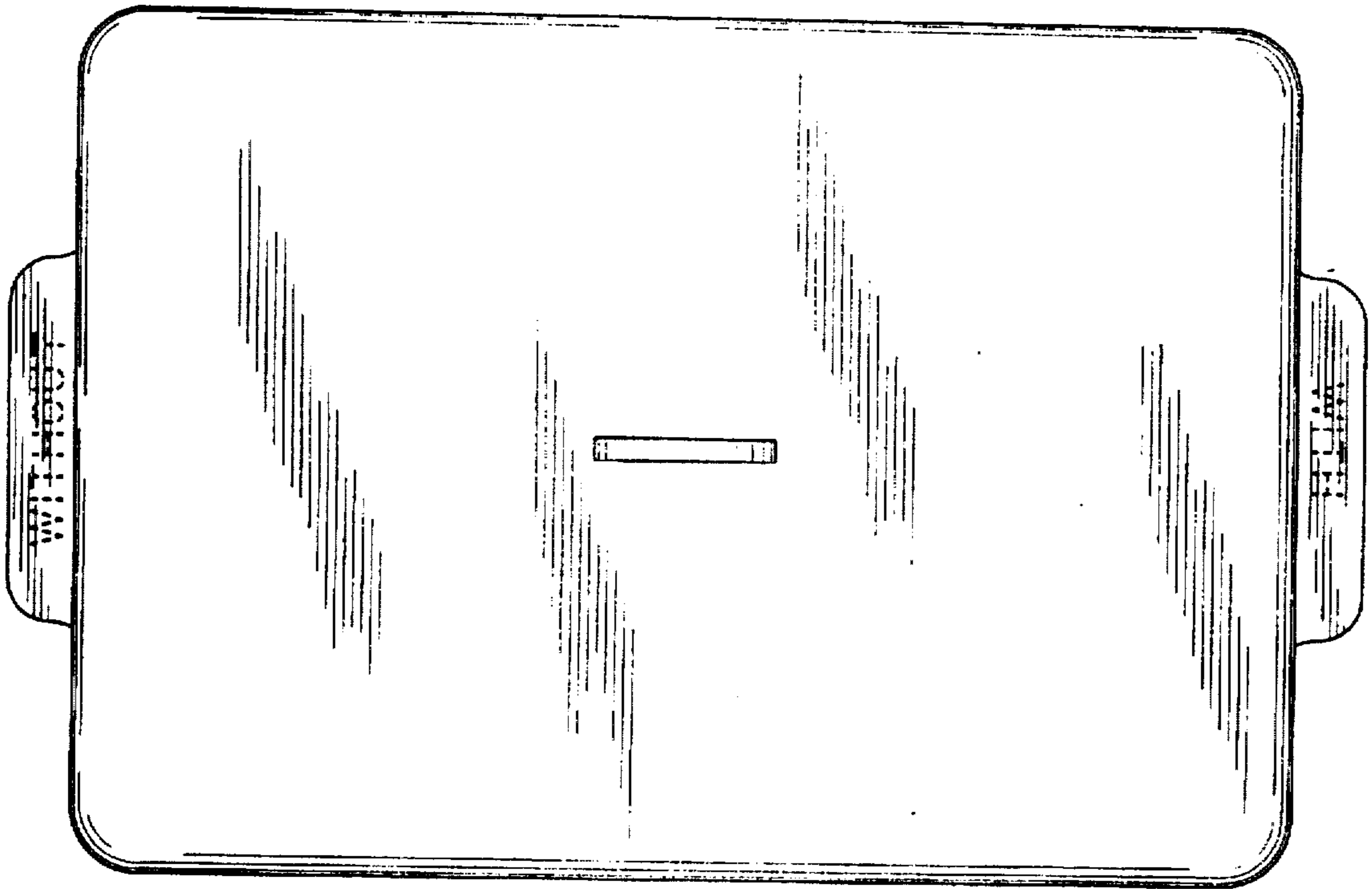

FIG. 6

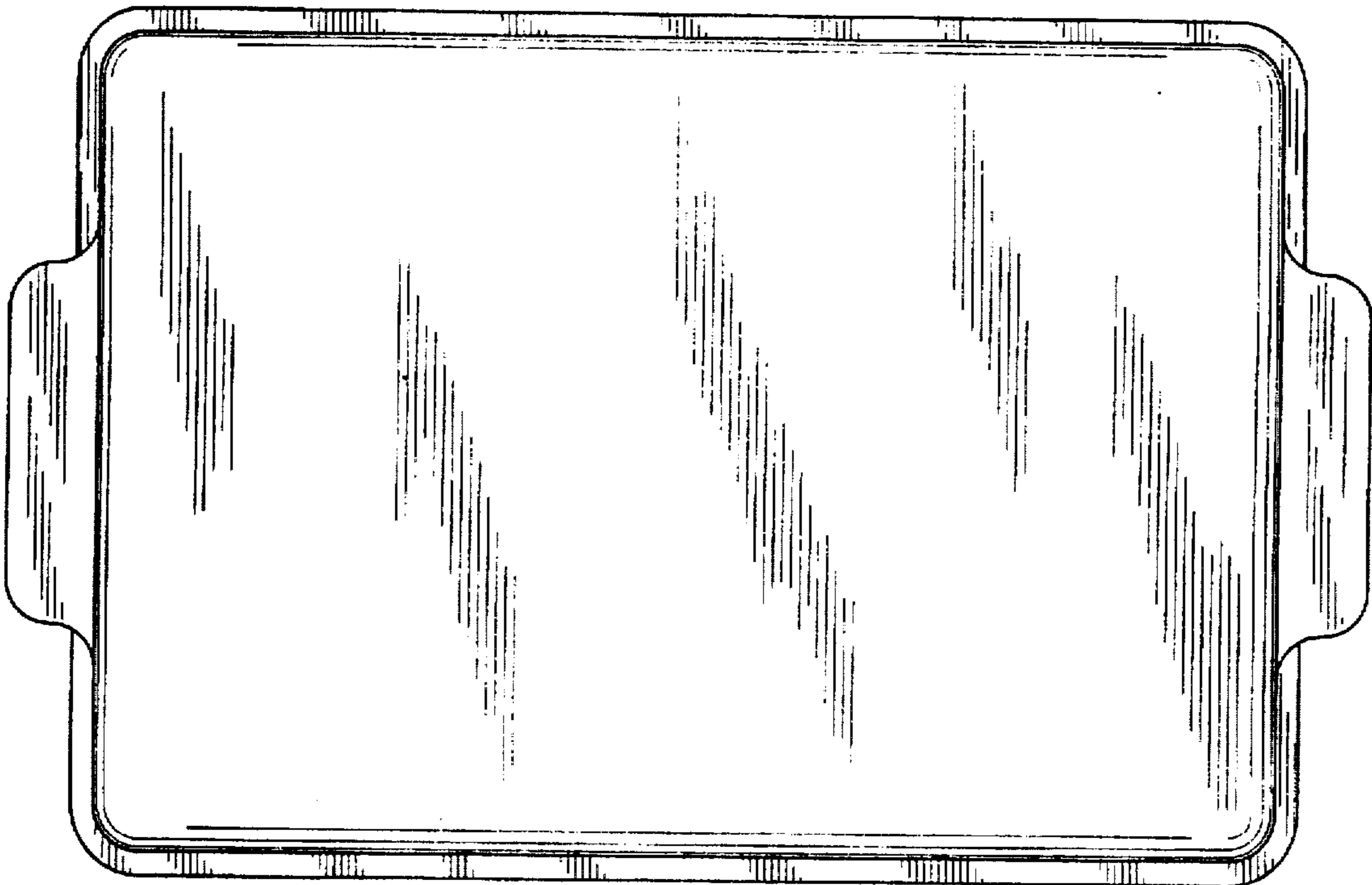

FIG. 7

