



US00D408220S

# United States Patent [19] Chomik

[11] Patent Number: Des. 408,220  
[45] Date of Patent: \*\*Apr. 20, 1999

## [54] CUP WITH STRAW-SEALING CAP

[75] Inventor: Richard S. Chomik, Garwood, N.J.

[73] Assignee: Playtex Products, Inc., Westport, Conn.

[\*\*] Term: 14 Years

[21] Appl. No.: 29/073,578

[22] Filed: Jul. 11, 1997

[51] LOC (6) Cl. .... 07-01

[52] U.S. Cl. .... D7/510; D7/511

[58] Field of Search ..... D7/536, 533, 510, D7/511, 523, 509, 513, 512, 532, 534, 619, 626, 535, 571, 514; 220/553, 555, 672, 675, 705, 708, 709, 756, 771; D9/525, 530, 559, 537, 569, 557; 215/382

## [56] References Cited

### U.S. PATENT DOCUMENTS

- D. 289,484 4/1987 Forquer et al. .
- D. 306,262 2/1990 Bit ..... D9/557
- D. 358,296 5/1995 Gameau ..... D7/510
- D. 366,809 2/1996 Green .
- D. 367,206 2/1996 Green ..... D7/511
- D. 370,828 6/1996 Green ..... D7/510
- D. 371,048 6/1996 Green ..... D7/510
- D. 379,306 5/1997 Peykoff ..... D9/557 X
- 1,071,817 9/1913 Stanley .
- 2,695,719 11/1954 Faris .
- 2,715,326 8/1955 Gits .
- 2,788,149 4/1957 Brown .
- 2,808,167 10/1957 Polazzolo .
- 2,863,585 12/1958 Meshberg .
- 2,899,098 8/1959 Gits .
- 2,981,430 4/1961 Tsien et al. .
- 3,120,570 2/1964 Kennedy et al. .
- 3,677,524 7/1972 Douglas .
- 3,755,030 8/1973 Doman et al. .
- 3,804,281 4/1974 Eckdahl .
- 3,827,925 8/1974 Douglas .
- 3,972,443 8/1976 Albert .
- 4,099,642 7/1978 Nergard .
- 4,151,923 5/1979 Bernardi .

- 4,301,942 11/1981 Kupperman et al. .
- 4,303,173 12/1981 Nergard .
- 4,789,073 12/1988 Fine .
- 5,038,948 8/1991 Signorini .
- 5,150,815 9/1992 Saklad .
- 5,273,172 12/1993 Rossbach et al. .
- 5,329,778 7/1994 Padamsee .
- 5,339,977 8/1994 Schormair et al. .... 220/672 X
- 5,339,982 8/1994 Tardie .
- 5,628,453 5/1997 MacLaughlin .
- 5,632,397 5/1997 Fandoux et al. .... 215/382

### FOREIGN PATENT DOCUMENTS

- 1122663 8/1968 United Kingdom .
- 1281534 7/1972 United Kingdom .

### OTHER PUBLICATIONS

"Power Bottles" brochure, Bicycling Magazine, Apr., 1995, p. 85.

Primary Examiner—M. N. Pandozzi  
Attorney, Agent, or Firm—Ohlandt, Greeley, Ruggiero & Perle L.L.P.

## [57] CLAIM

The ornamental design for the cup with straw-sealing cap, as shown and described.

### DESCRIPTION

FIG. 1 is a perspective view of a cup with straw-sealing cap, with its cap open and straw extended, showing my new design;  
 FIG. 2 is a side view of the assembled cup with straw-sealing cap of FIG. 1, wherein a second side view would be a mirror image thereof;  
 FIG. 3 is a front view of the cup with straw-sealing cap of FIG. 1;  
 FIG. 4 is a rear view of the cup with straw-sealing cap of FIG. 1;  
 FIG. 5 is a top view of the cup with straw-sealing cap of FIG. 1; and ,  
 FIG. 6 is a bottom view of the cup with straw-sealing cap of FIG. 1.

1 Claim, 5 Drawing Sheets

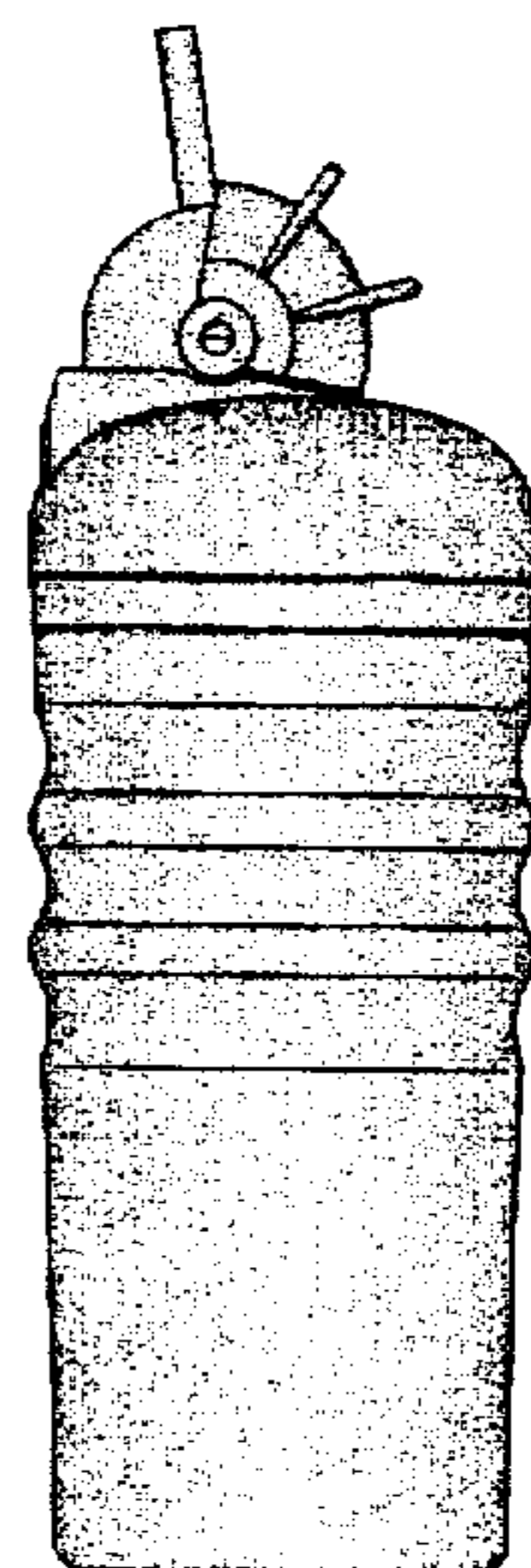

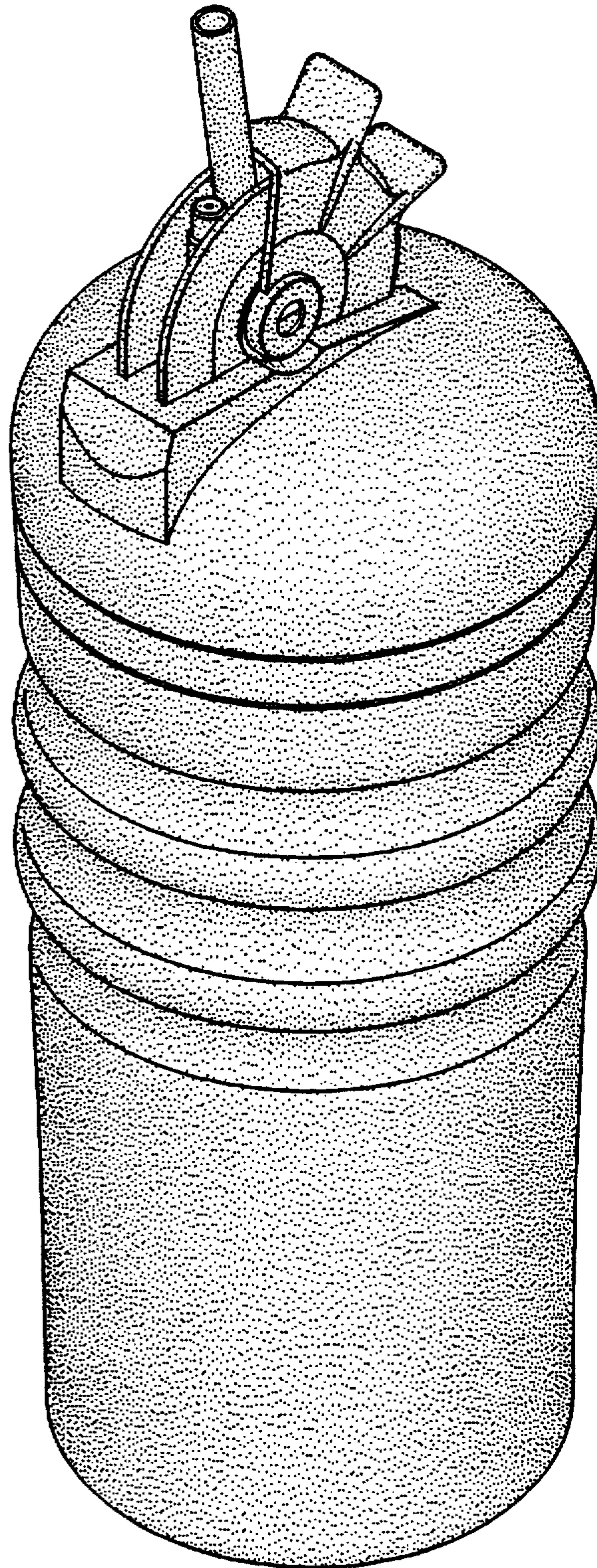

FIG. 1

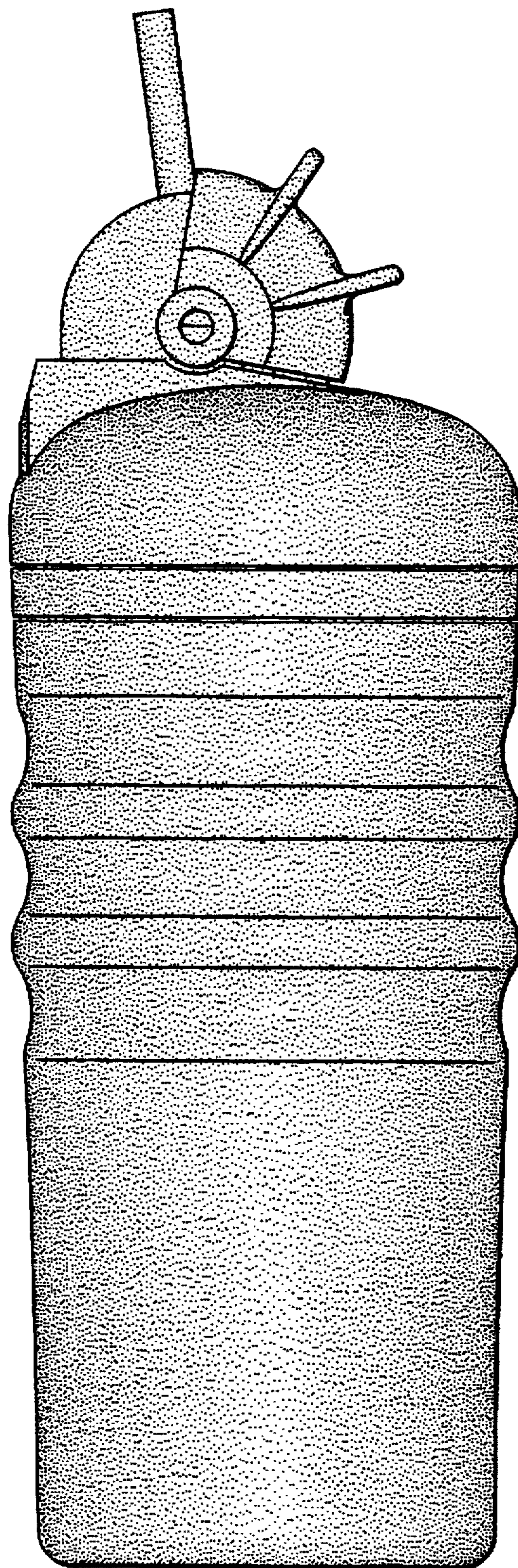

FIG. 2

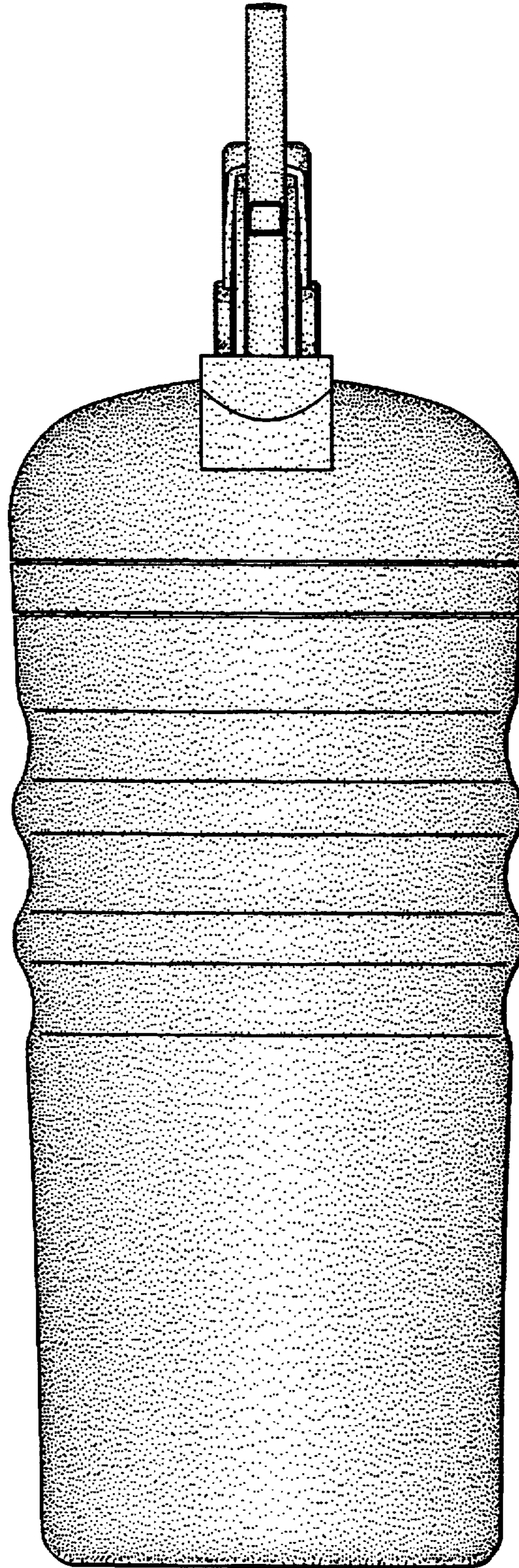

FIG. 3

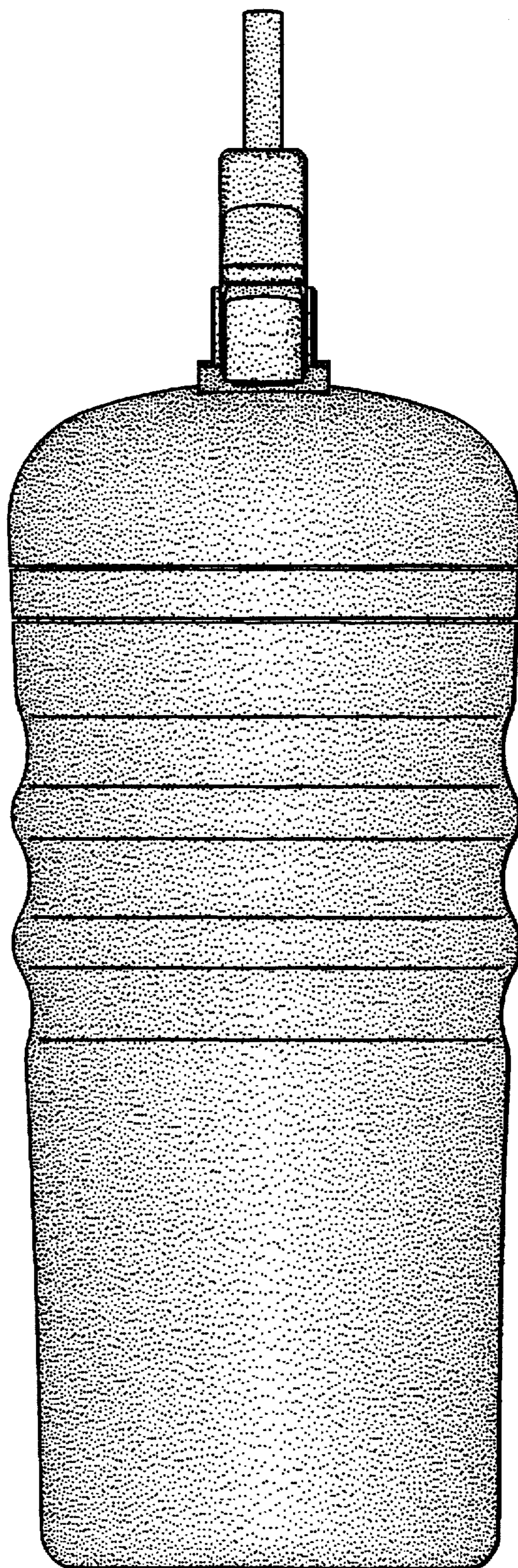

FIG. 4

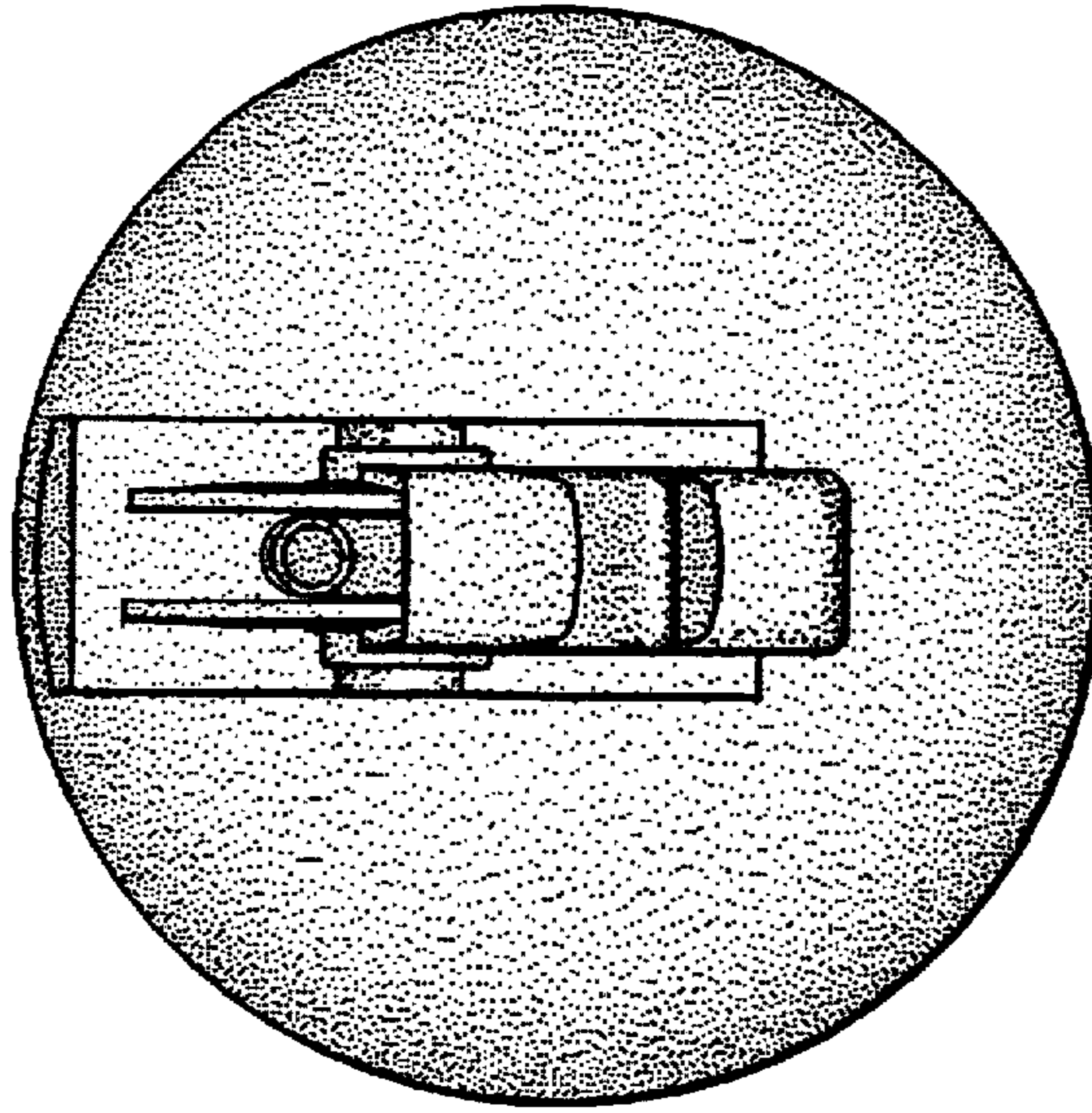

FIG. 5

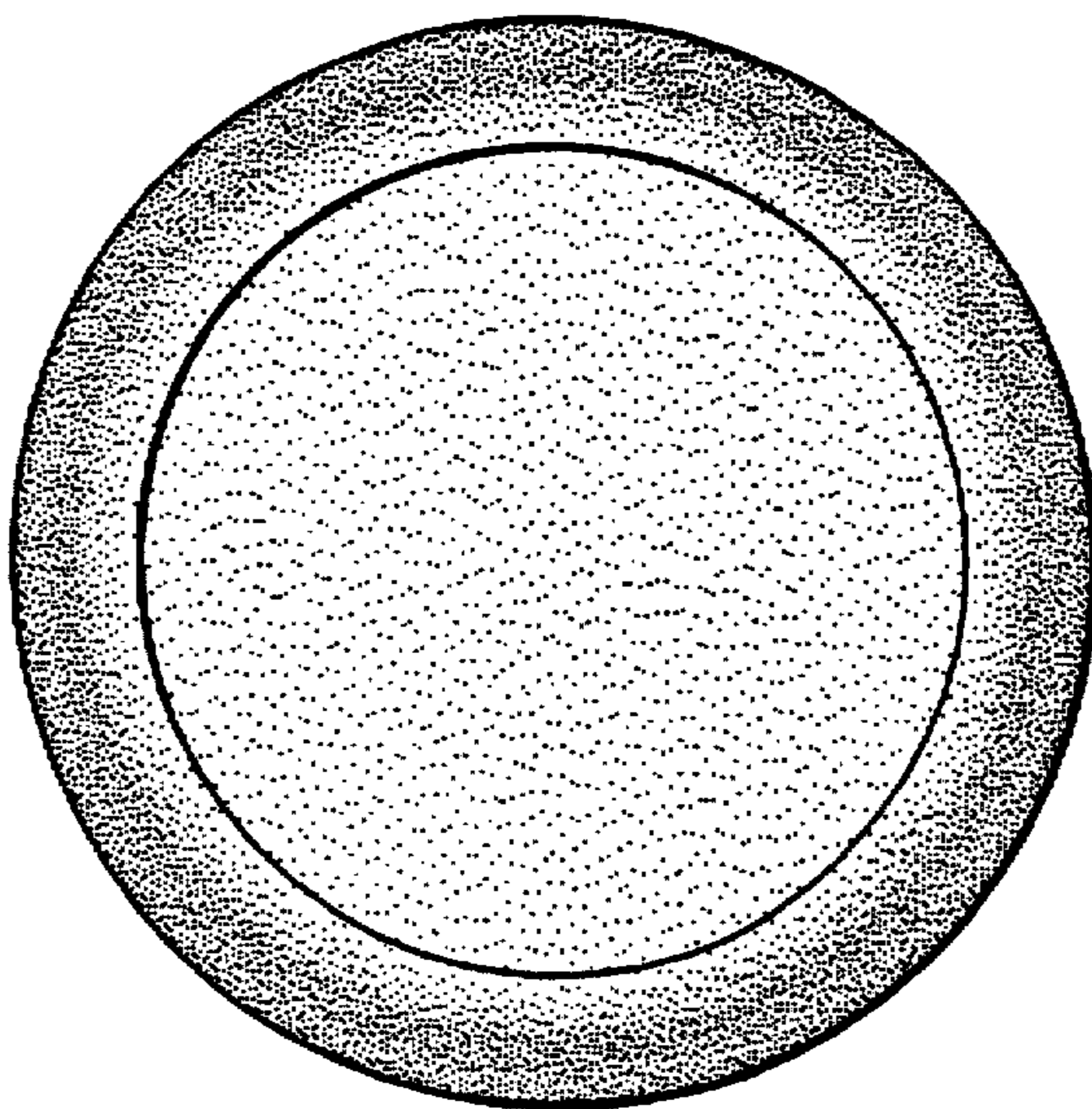

FIG. 6