



US00D408179S

**United States Patent** [19]  
**Rellinger**

[11] **Patent Number:** **Des. 408,179**  
[45] **Date of Patent:** **\*\*Apr. 20, 1999**

[54] **BOARD HOLDER OR SUPPORT**  
[75] **Inventor:** Michael Rellinger, Chicago, Ill.  
[73] **Assignee:** Quartet Manufacturing Company, Skokie, Ill.  
[\*\*] **Term:** 14 Years  
[21] **Appl. No.:** 29/083,792  
[22] **Filed:** Feb. 12, 1998  
[51] **LOC (6) CL** ..... 06-99  
[52] **U.S. Cl.** ..... D6/491; D6/310  
[58] **Field of Search** ..... D6/300, 310-314; D19/52; 248/441.1, 445, 450, 451, 454, 455, 460, 453, 448, 449; D8/373

5,744,735 4/1998 Liao ..... 248/460  
*Primary Examiner*—Janice E. Seeger  
*Attorney, Agent, or Firm*—Martin Faier; Faier & Faier P.C.

[57] **CLAIM**

The ornamental design for a board holder or support, as shown and described.

**DESCRIPTION**

FIG. 1 is a perspective view of a board holder or support mounted in extended position, showing my new design. The broken line showing of the easel is for environmental purposes only and forms no part of the claimed design. FIG. 2 is a side elevational view showing the holders mounted in folded position; FIG. 3 is a side elevational view, the opposite side being a mirror image thereof; FIG. 4 is a front elevational view; FIG. 5 is a rear elevational view; FIG. 6 is a top plan view; and, FIG. 7 is a bottom plan view thereof.

[56] **References Cited**

**U.S. PATENT DOCUMENTS**

D. 271,454	11/1983	Forte	.....	D6/312
D. 274,591	7/1984	Daenen	.....	D8/373
D. 293,416	12/1987	Krueger	.....	D8/373
2,912,203	11/1959	Townsend	.....	248/448

**1 Claim, 1 Drawing Sheet**

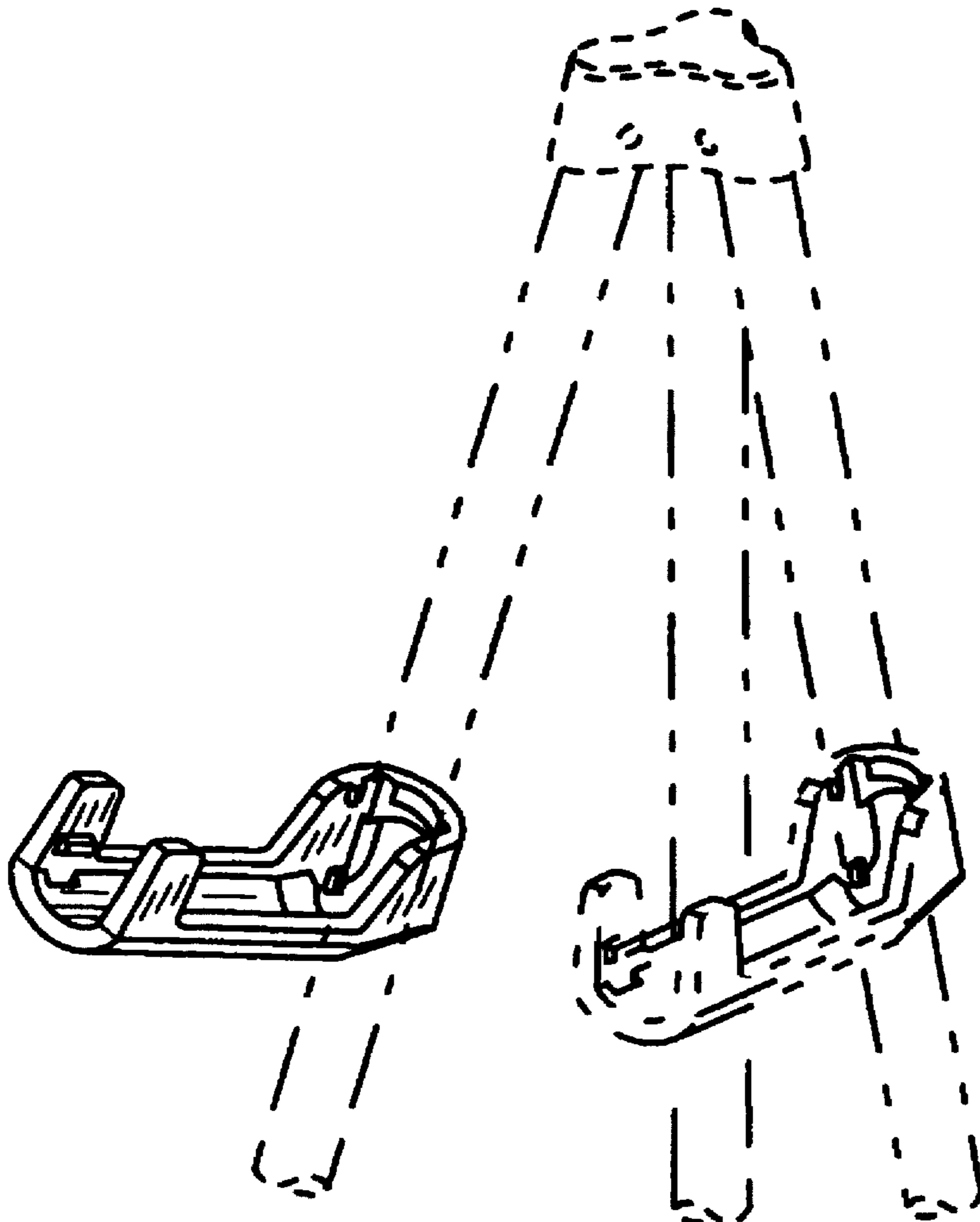

FIG. 1

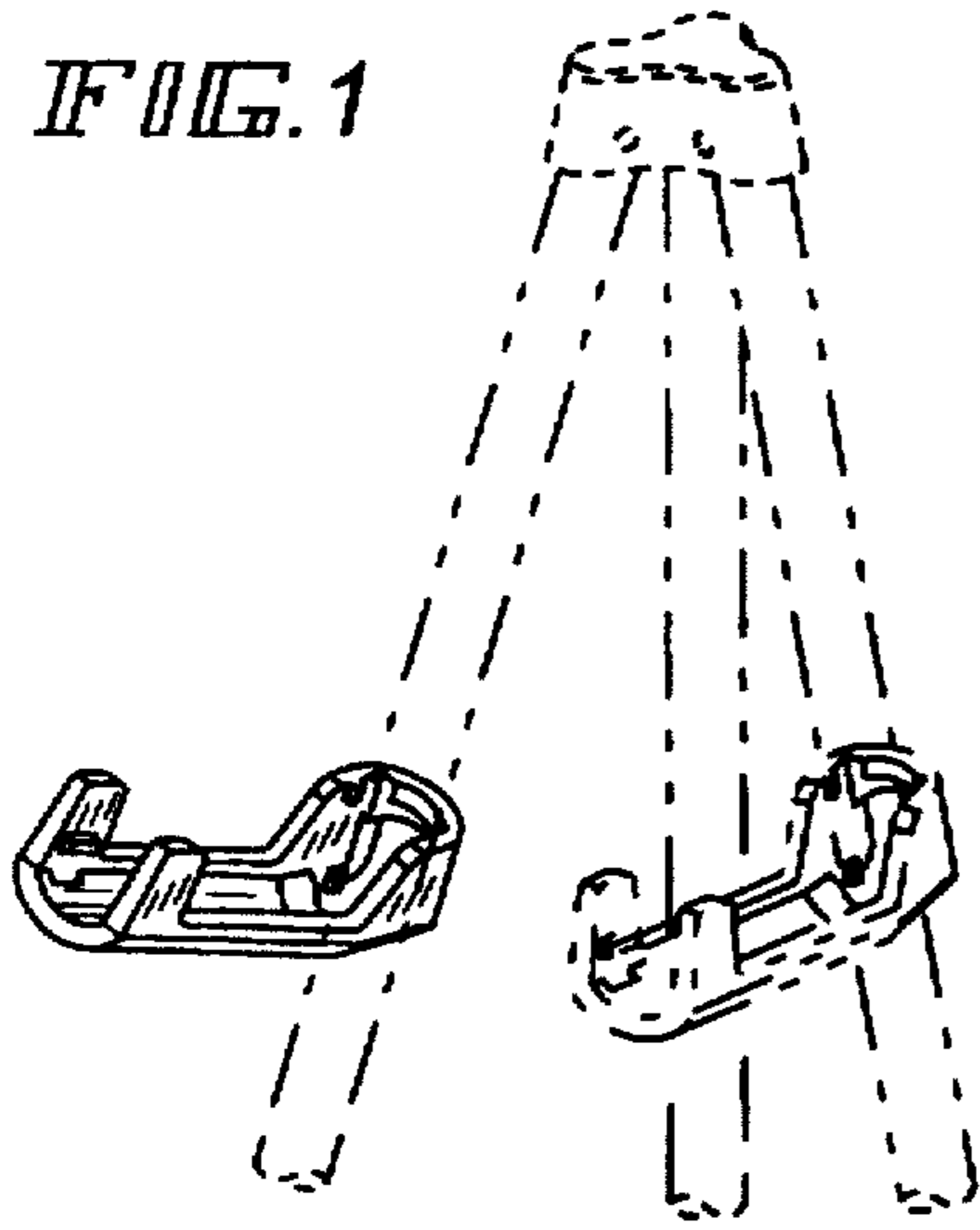

FIG. 2

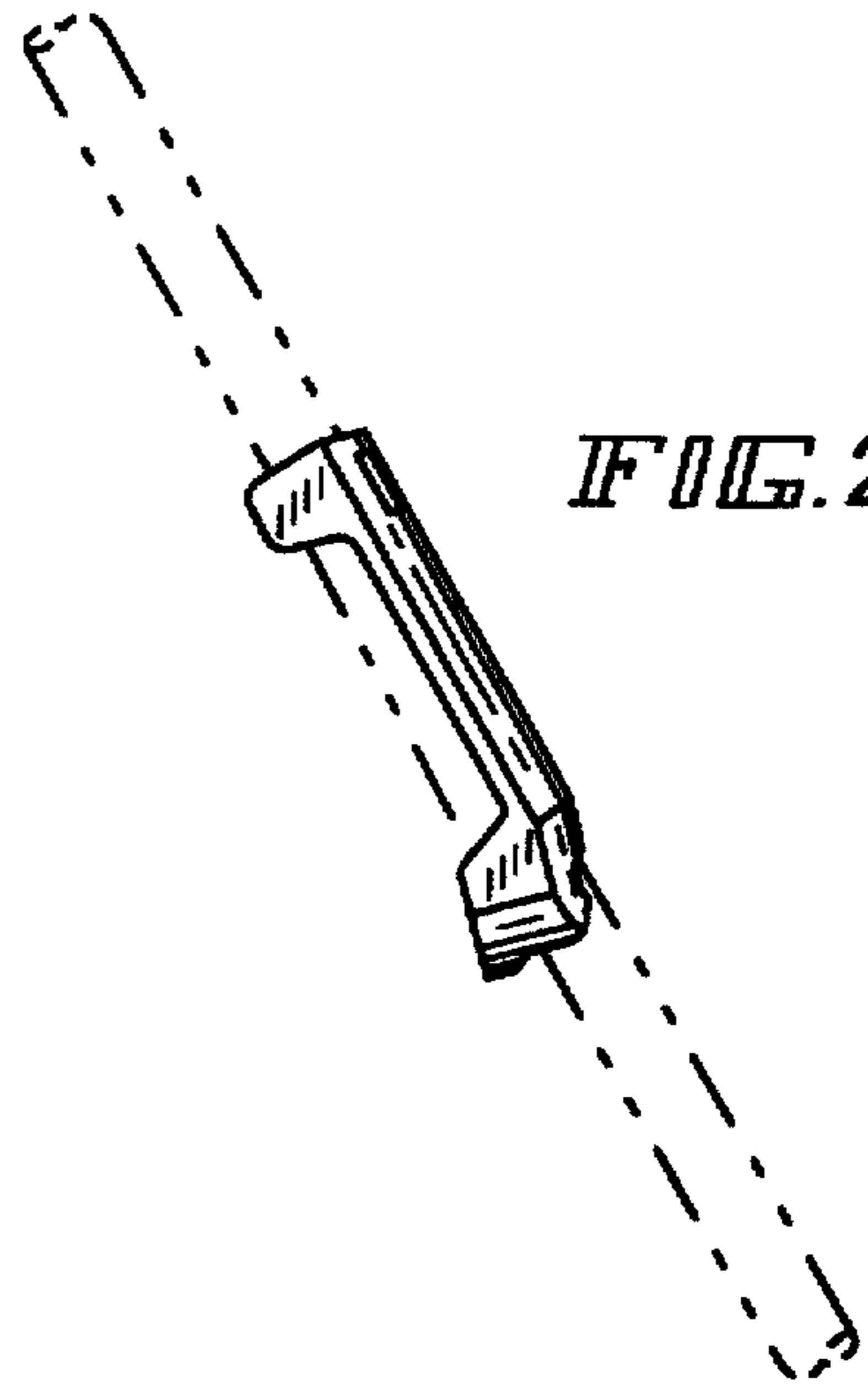

FIG. 3

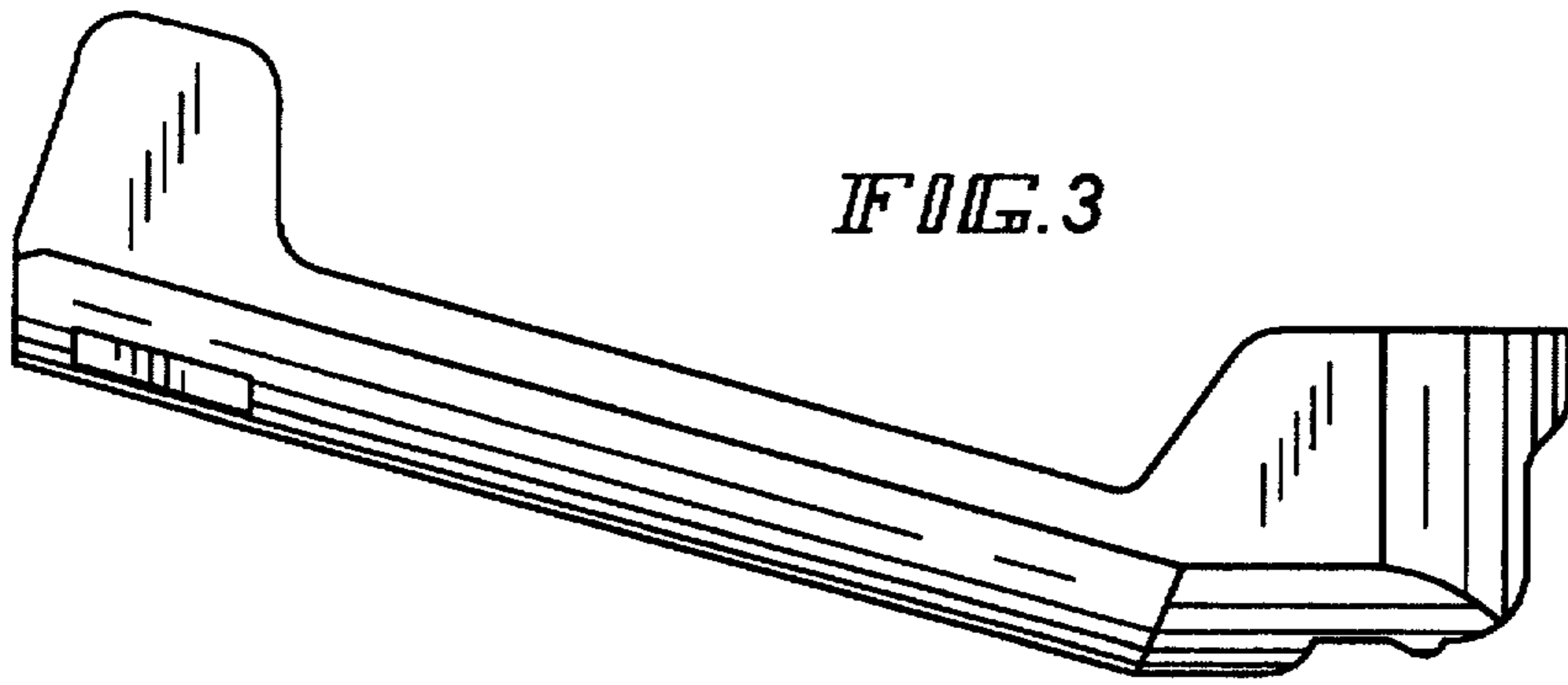

FIG. 4

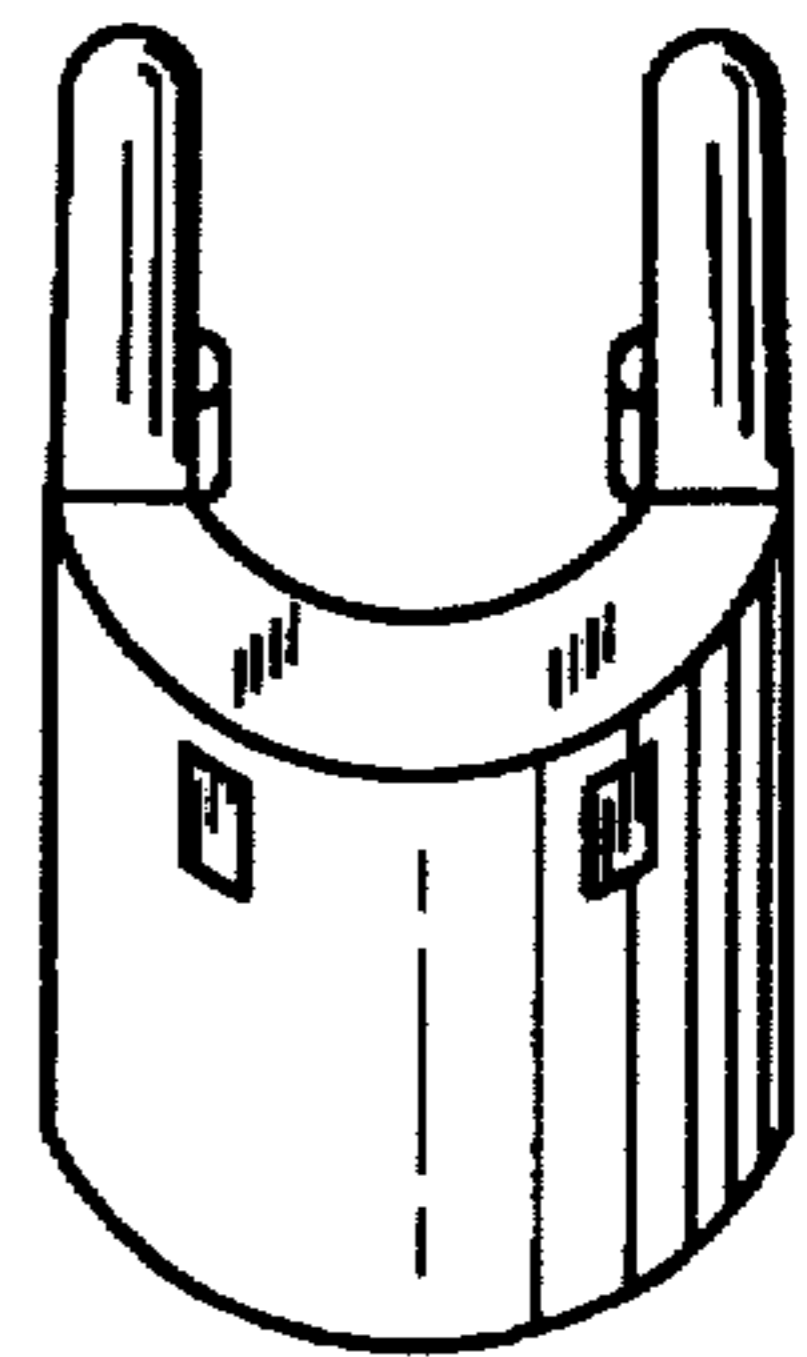

FIG. 6

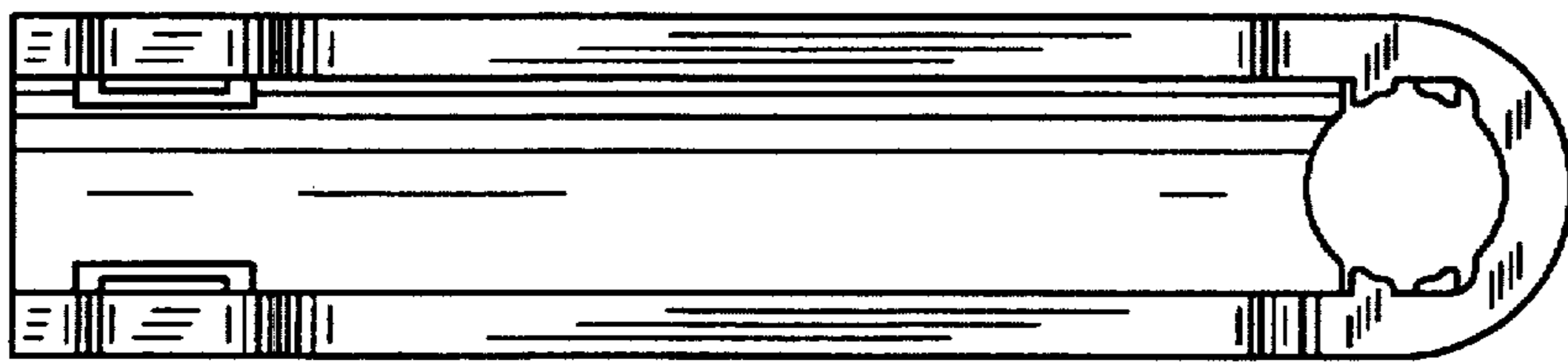

FIG. 5

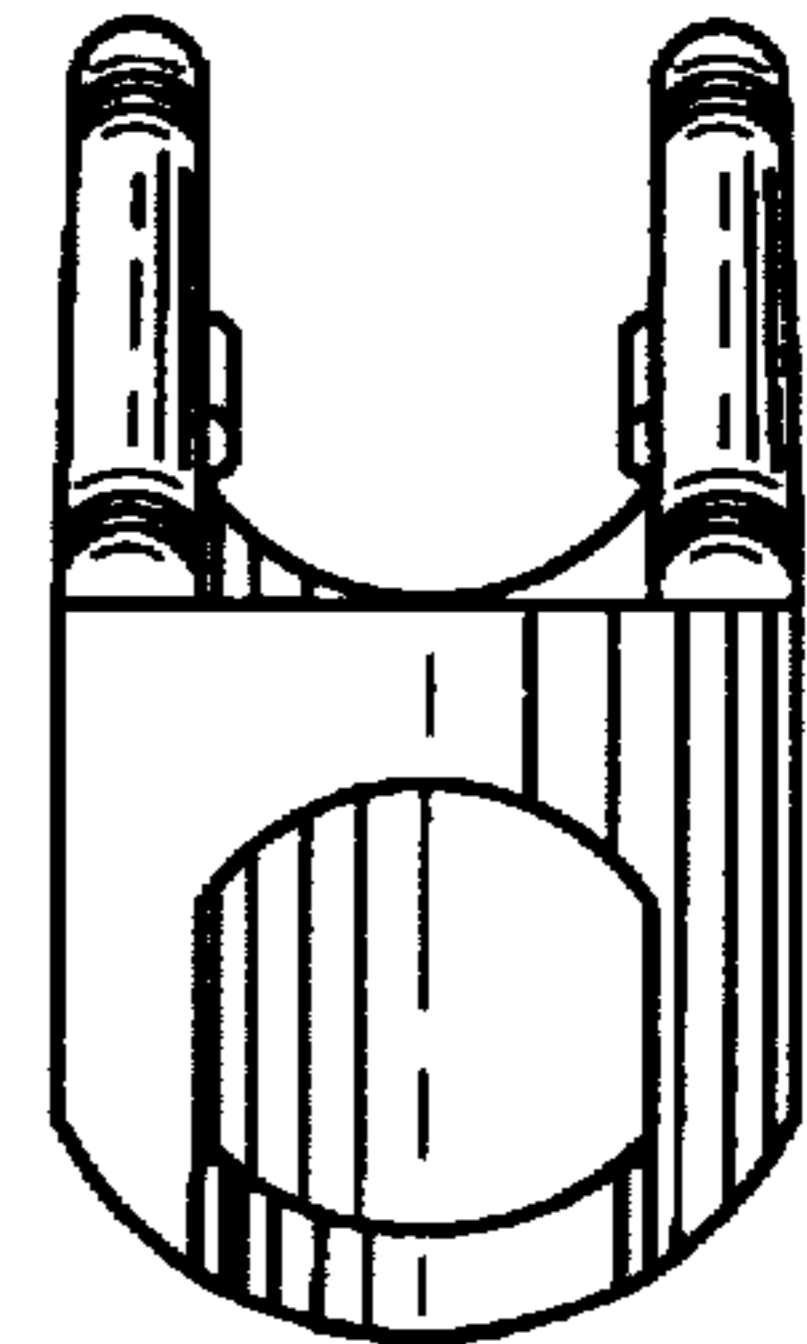

FIG. 7

