



US00D408169S

# United States Patent [19] Welborn, Jr.

[11] Patent Number: Des. 408,169  
[45] Date of Patent: \*\*Apr. 20, 1999

## [54] COMPUTER CABINET

- [75] Inventor: Earl Dalton Welborn, Jr., Davidson County, N.C.
- [73] Assignee: Hooker Furniture Corporation, Martinsville, Va.
- [\*\*] Term: 14 Years
- [21] Appl. No.: 29/090,113
- [22] Filed: Jun. 30, 1998
- [51] LOC (6) Cl. .... 06-04
- [52] U.S. Cl. .... D6/445
- [58] Field of Search ..... D6/432-448; 312/204, 312/257

## [56] References Cited

### U.S. PATENT DOCUMENTS

|            |         |                          |        |
|------------|---------|--------------------------|--------|
| D. 182,841 | 5/1958  | Lubberts et al. ....     | D6/439 |
| D. 198,319 | 6/1964  | Smith .....              | D6/445 |
| D. 307,681 | 5/1990  | Bush et al. ....         | D6/436 |
| D. 307,682 | 5/1990  | Bush et al. .            |        |
| D. 340,152 | 10/1993 | Short .....              | D6/436 |
| D. 340,153 | 10/1993 | Keller .                 |        |
| D. 343,073 | 1/1994  | Black .....              | D6/436 |
| D. 357,599 | 4/1995  | Kelley .                 |        |
| D. 364,756 | 12/1995 | Felber .                 |        |
| D. 364,759 | 12/1995 | Walters, III et al. .... | D6/445 |
| D. 371,018 | 6/1996  | Paus .                   |        |
| D. 371,019 | 6/1996  | Walters, III et al. .    |        |
| D. 376,491 | 12/1996 | Kelley .                 |        |

## OTHER PUBLICATIONS

American of Martinsville, inside back cover; entertainer #7706-773 on page, May 11, 1983.  
 Hooker Furniture Corporation Sales Brochure for Computer Cabinet, No. 073-10-305 disclosing the Applicant's claimed design, brochure dated Apr., 1998.

*Primary Examiner*—Carmen H Vales-Lado  
*Attorney, Agent, or Firm*—J. Michael Martinez de Andino; McGuire, Woods, Battle & Boothe LLP

## [57] CLAIM

The ornamental design for a computer cabinet, as shown and described.

## DESCRIPTION

FIG. 1 is a front, left side perspective view of a computer cabinet showing my new design;  
 FIG. 2 is a right side elevational view, the left side being a mirror image thereof;  
 FIG. 3 is a top plan view thereof;  
 FIG. 4 is a front elevational view thereof;  
 FIG. 5 is a front, left side perspective view with the doors opened and various interior members in extended position;  
 FIG. 6 is an enlarged detailed front elevational view of the upper left corner moulding; and,  
 FIG. 7 is an enlarged detailed perspective view thereof.

The showing of door/drawer handles in broken lines is for illustrative purposes only and forms no part of the claimed design. The rear of the cabinet is flat and unornamented and forms no part of the claimed design.

1 Claim, 7 Drawing Sheets

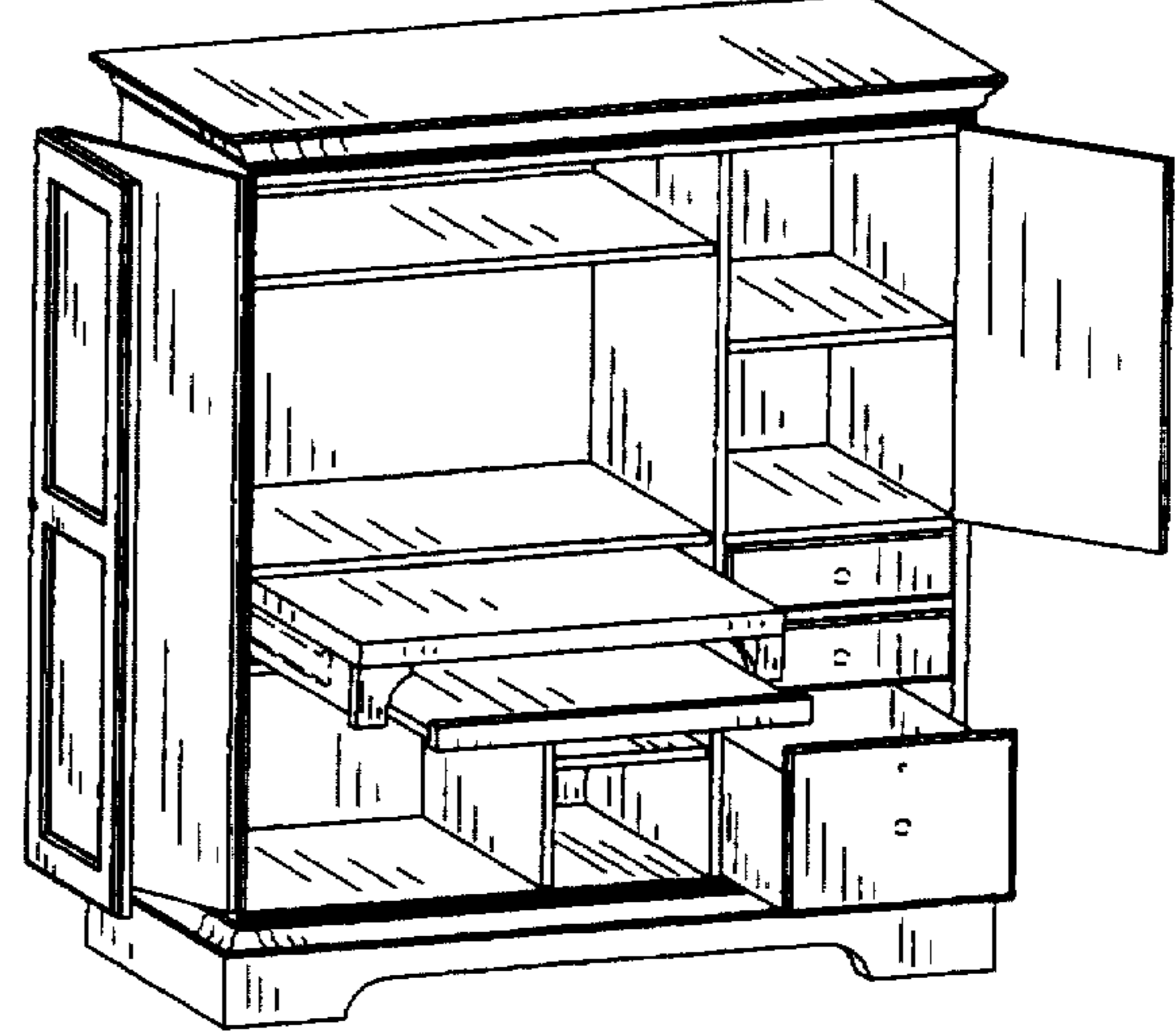
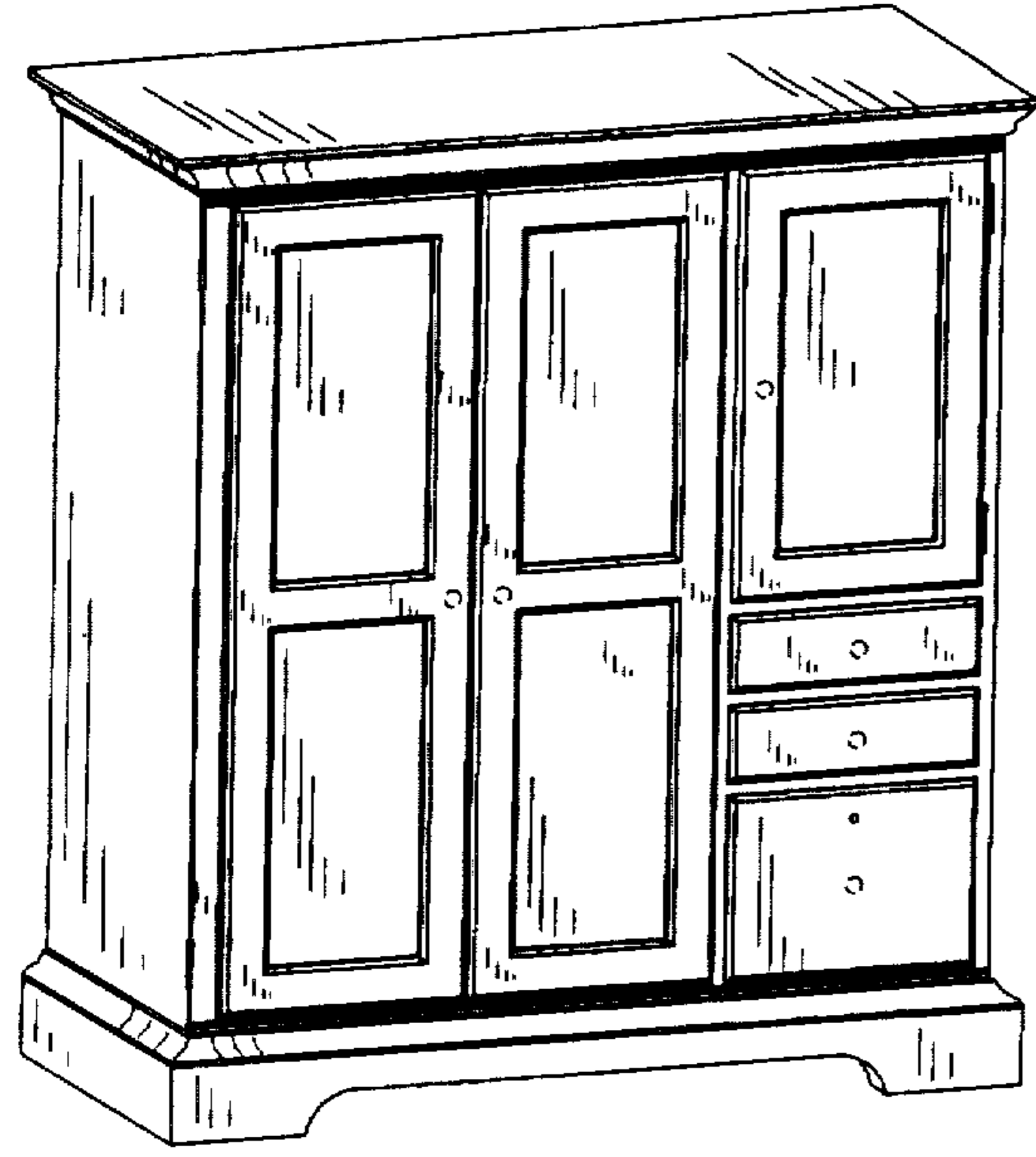

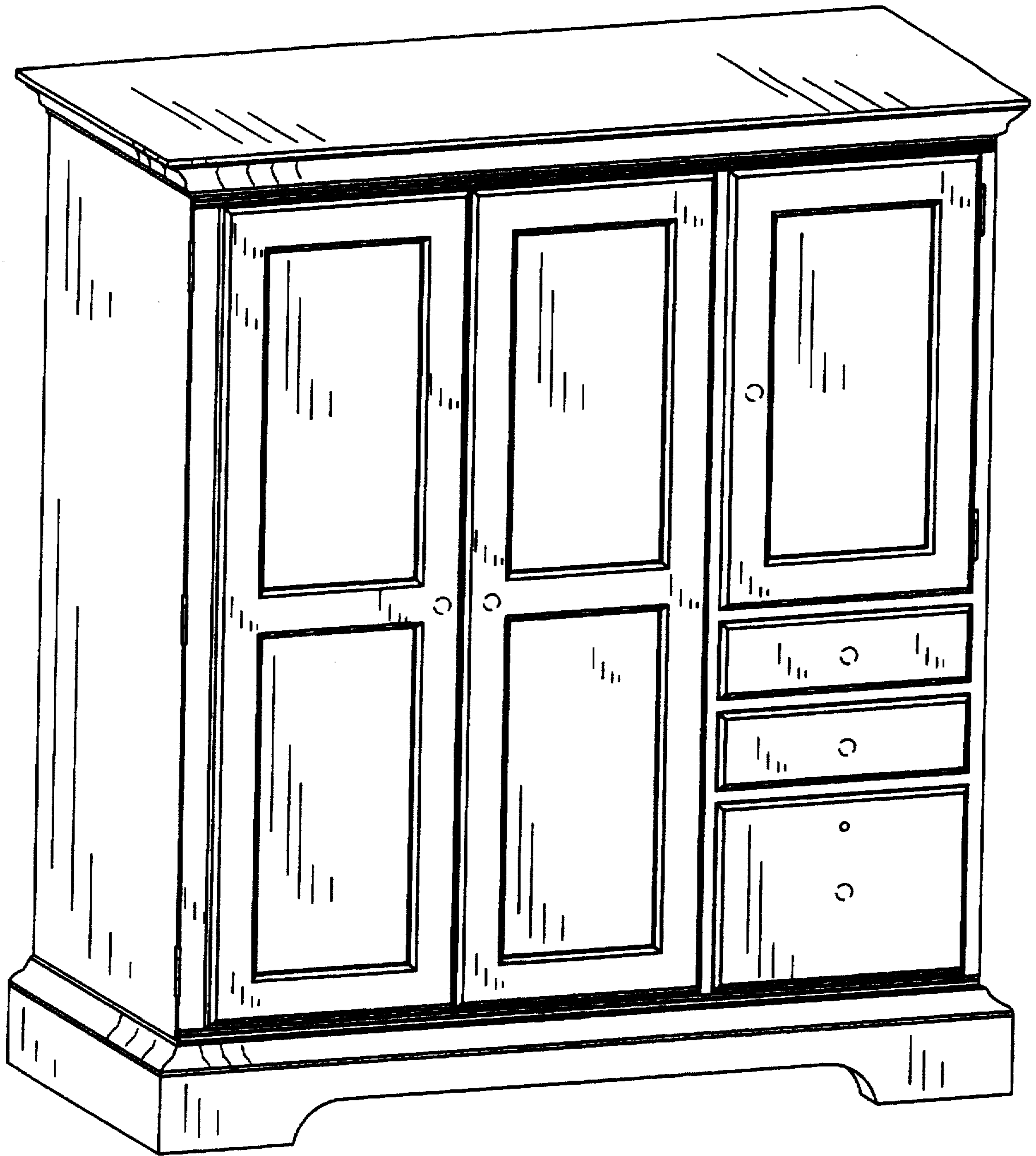

FIG. 1

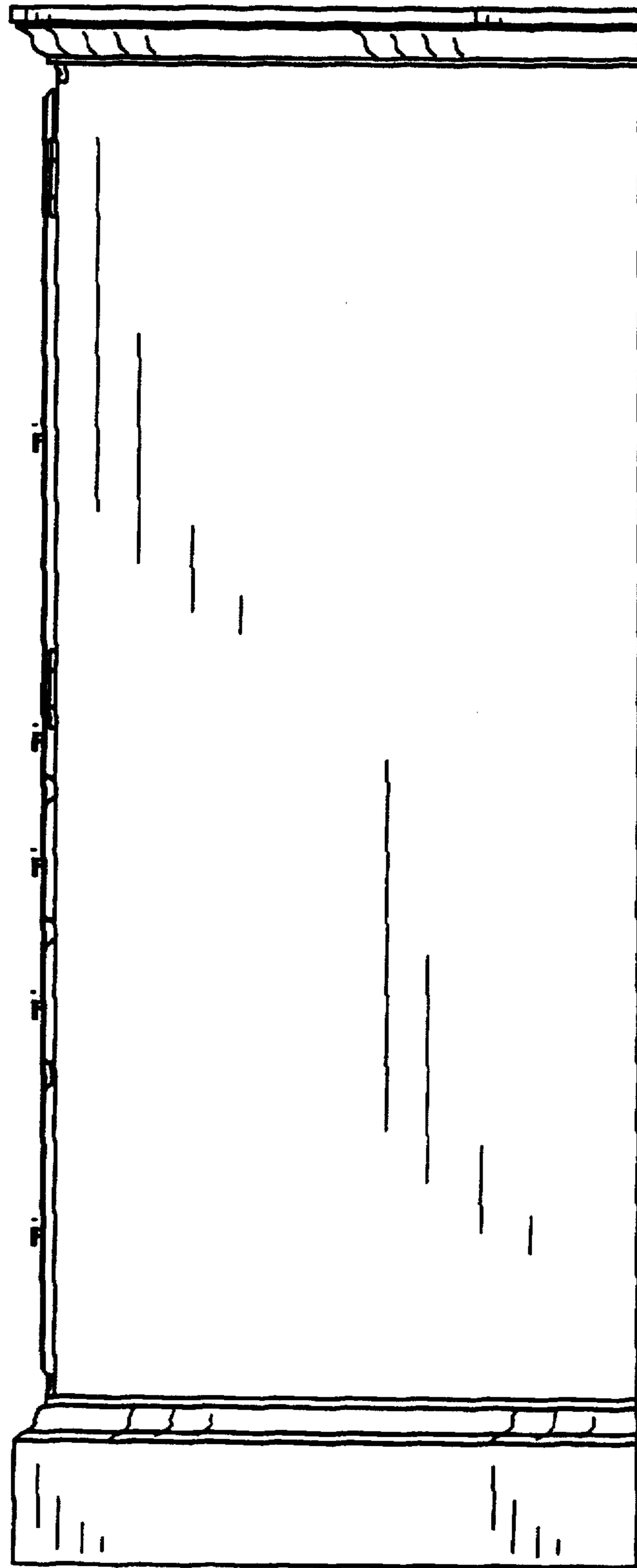
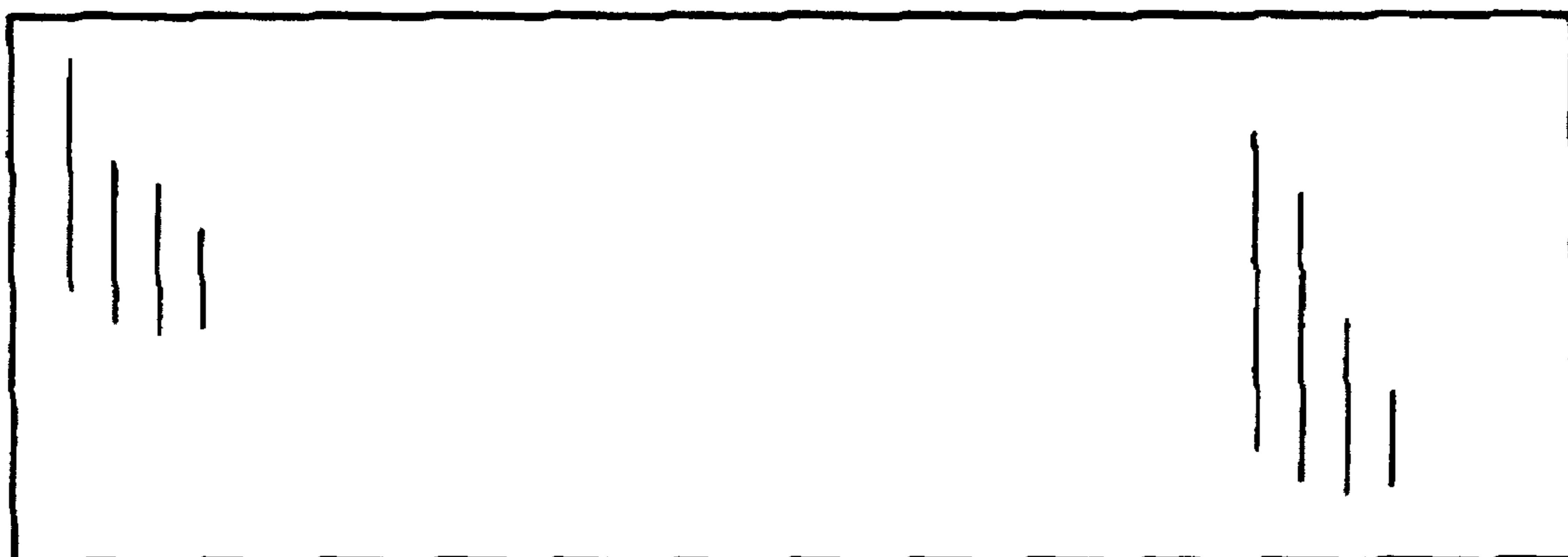

FIG. 2



*FIG. 3*

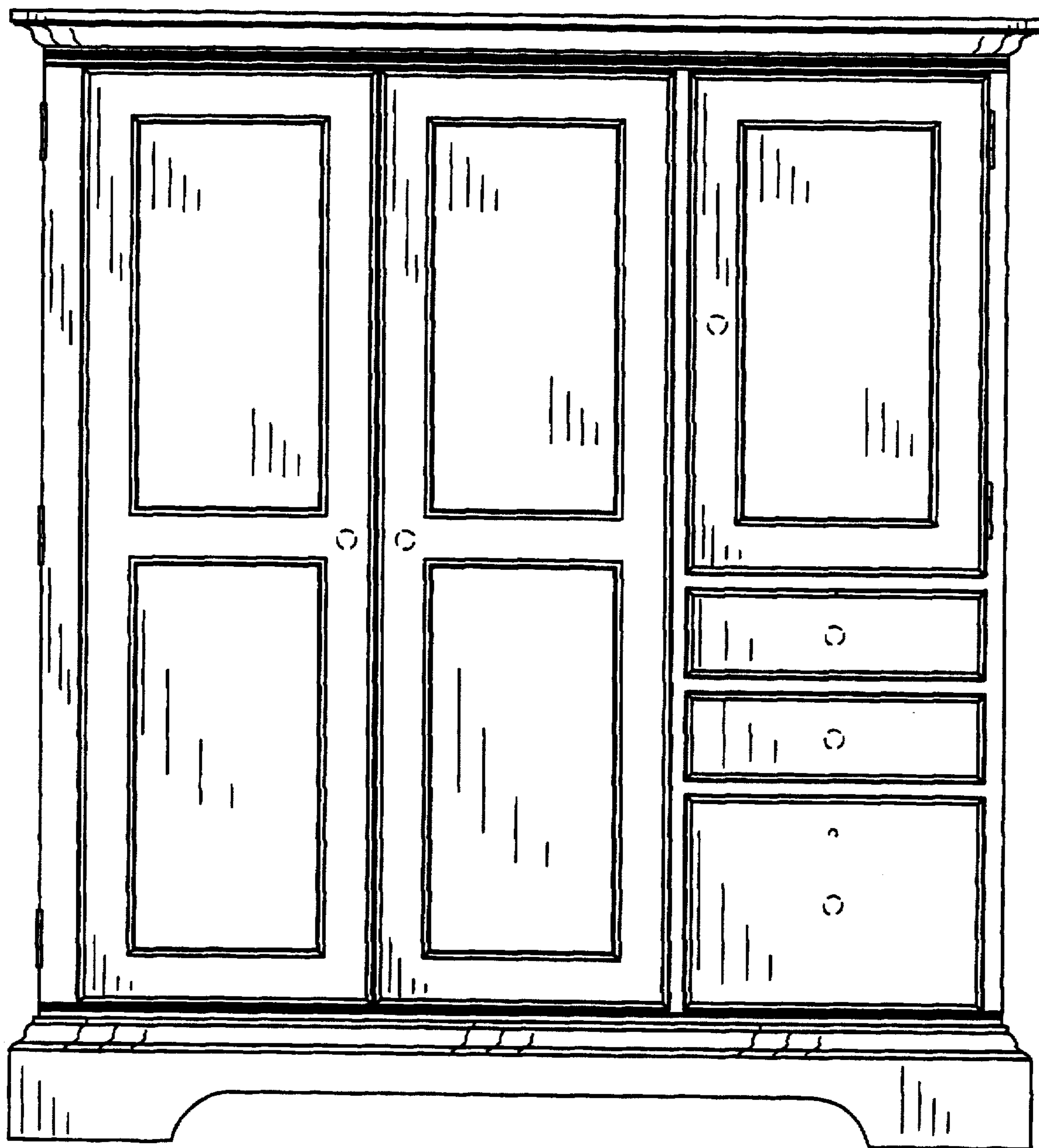

FIG. 4

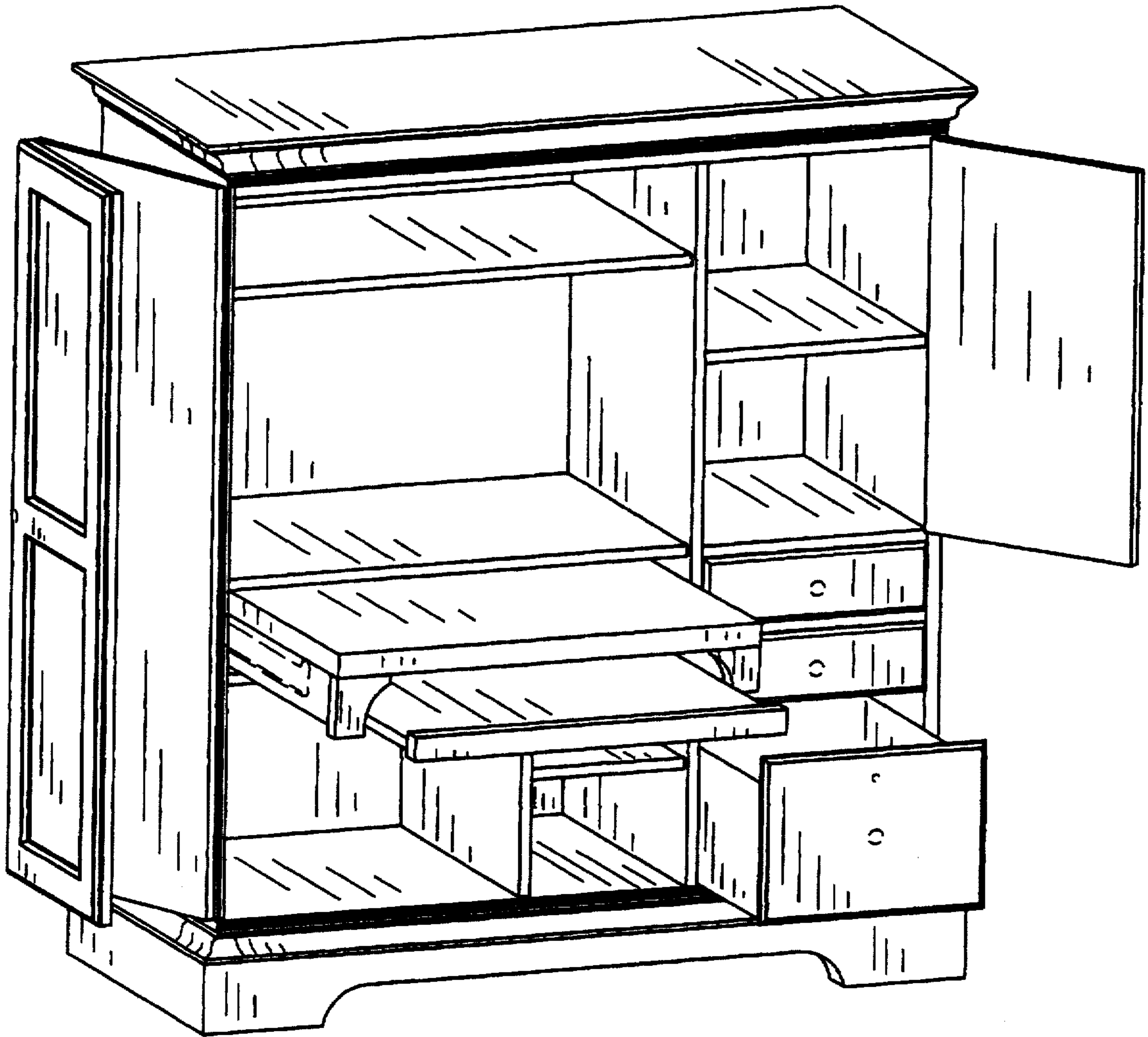

FIG. 5

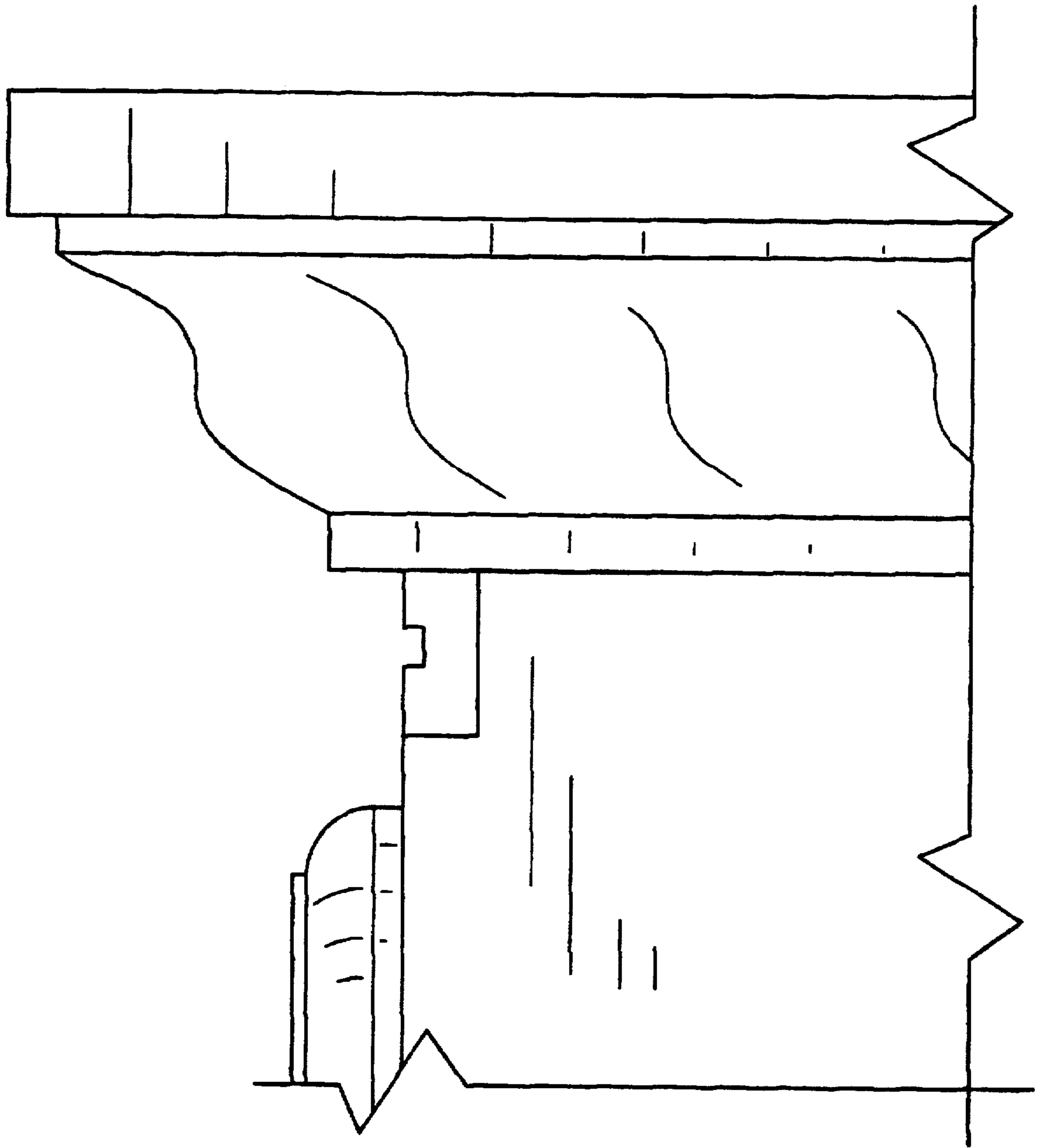
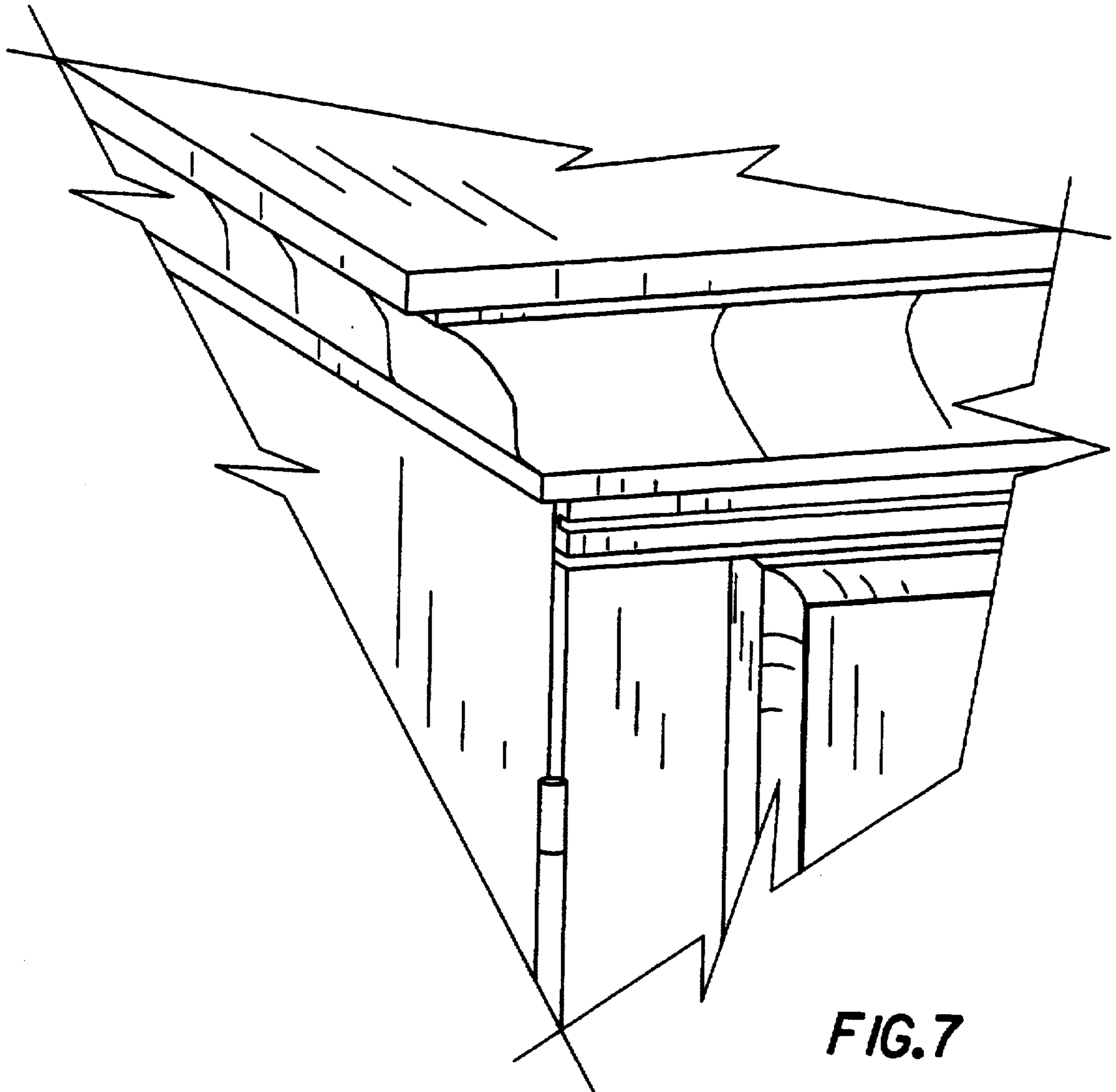

FIG. 6



**FIG. 7**