



US00D408154S

United States Patent [19]

[11] Patent Number: Des. 408,154

Kacius

[45] Date of Patent: **Apr. 20, 1999

[54] PHOTOGRAPH CABINET

Attorney, Agent, or Firm—Mark R. Galis

[75] Inventor: Timothy A. Kacius, Torrance, Calif.

[57] CLAIM

[73] Assignee: Tinker's Den, Inc., Torrance, Calif.

The ornamental design for an photograph cabinet, as shown and described.

[**] Term: 14 Years

DESCRIPTION

[21] Appl. No.: 29/090,850

FIG. 1 is a front elevational view of a photograph cabinet showing the first embodiment of our new design;

[22] Filed: Jul. 17, 1998

FIG. 2 is a rear elevational view of the cabinet shown in FIG. 1;

[51] LOC (6) Cl. 06-07

[52] U.S. Cl. D6/301; D6/300; D6/302

FIG. 3 is a top plan view of the cabinet shown in FIG. 1;

[58] Field of Search D6/300-302, 309-314, D6/470; 40/700, 711, 714, 720, 721, 722, 729-733, 735, 745-749, 765, 779, 790, 798

FIG. 4 is a bottom plan view of the cabinet shown in FIG. 1;

FIG. 5 is a left side view of the cabinet shown in FIG. 1;

FIG. 6 is a right side view of the cabinet shown in FIG. 1;

FIG. 7 is a perspective view of the interior of the cabinet of FIG. 1. The cabinet is opened periodically when it is used;

FIG. 8 is a front elevational view of a photograph cabinet showing the second embodiment of our new design;

FIG. 9 is a perspective view of the interior of the cabinet of FIG. 8. The cabinet is opened periodically when it is used.

FIG. 10 is a front elevational view of a photograph cabinet showing the third embodiment of our new design; and,

FIG. 11 is a perspective view of the interior of the cabinet of FIG. 10. The cabinet is opened periodically when it is used.

[56] References Cited

U.S. PATENT DOCUMENTS

D. 256,810	9/1980	Coleman	D20/10
D. 272,791	2/1984	Brobakken	D6/301
D. 292,651	11/1987	Stratton	D6/301
D. 332,528	1/1993	Neal	D6/301
D. 390,010	2/1998	Fry	D6/302
D. 391,406	3/1998	Field	D6/302
3,079,771	3/1963	Donle	40/735

Primary Examiner—Janice E. Seeger

1 Claim, 7 Drawing Sheets

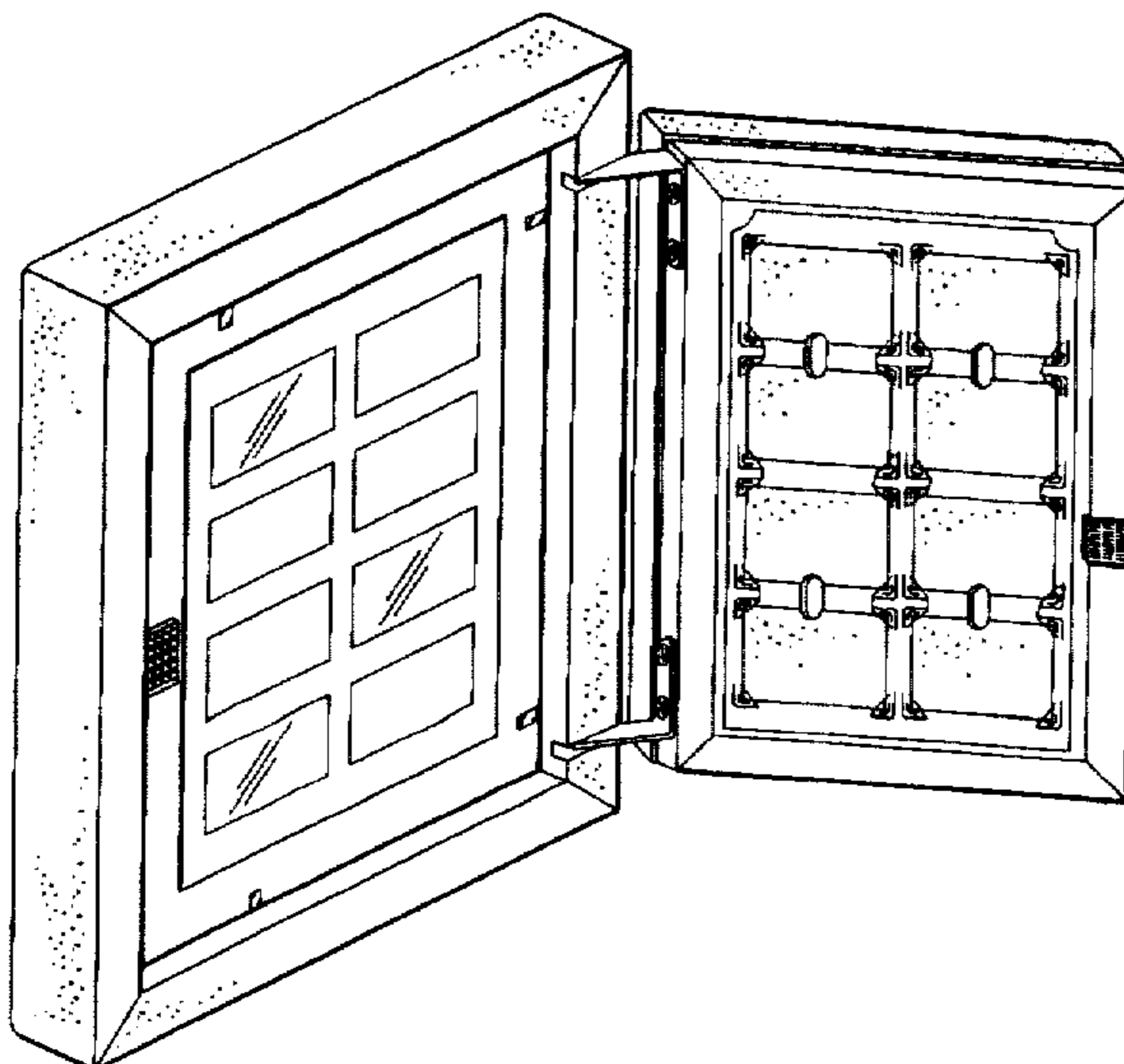
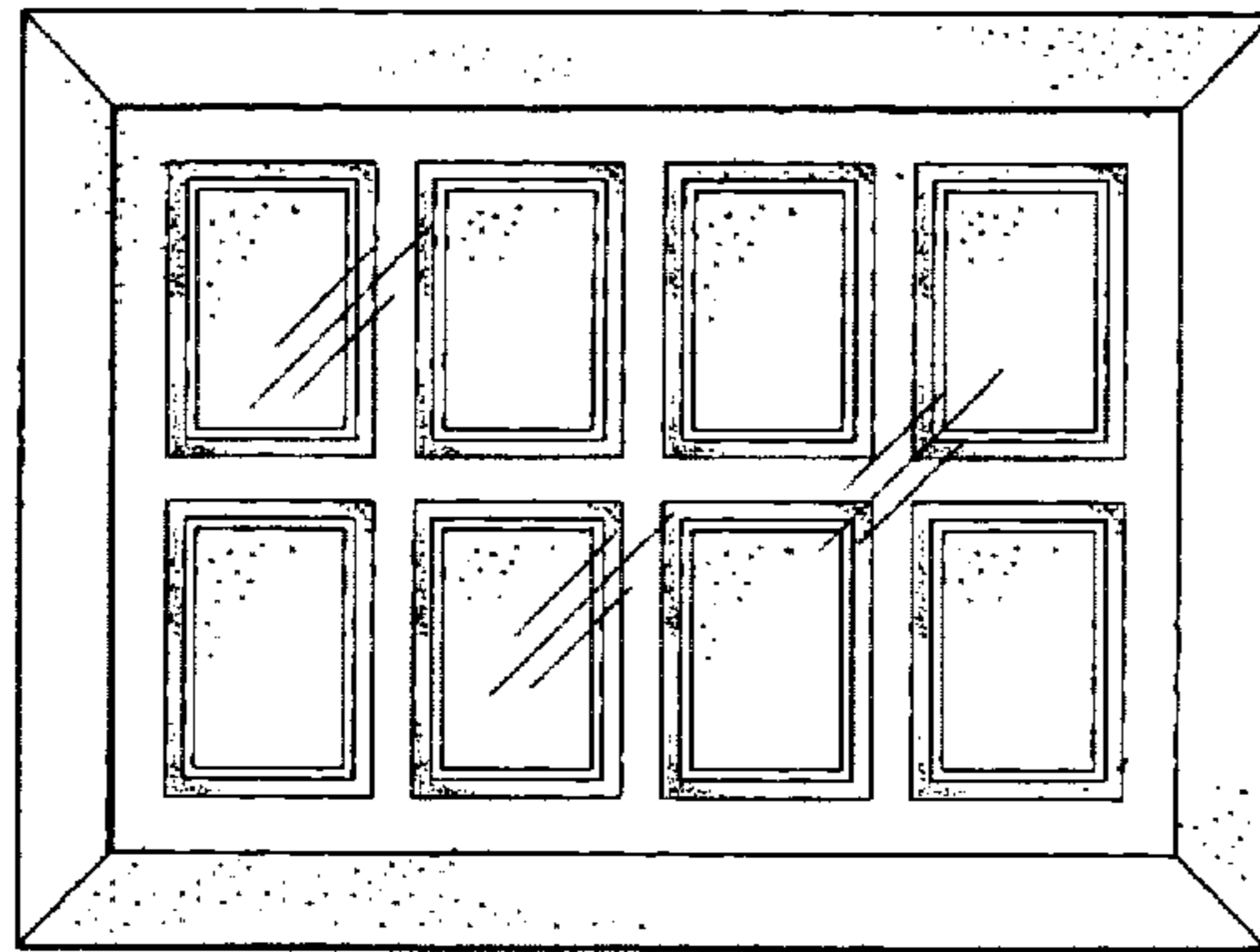

FIG. 1

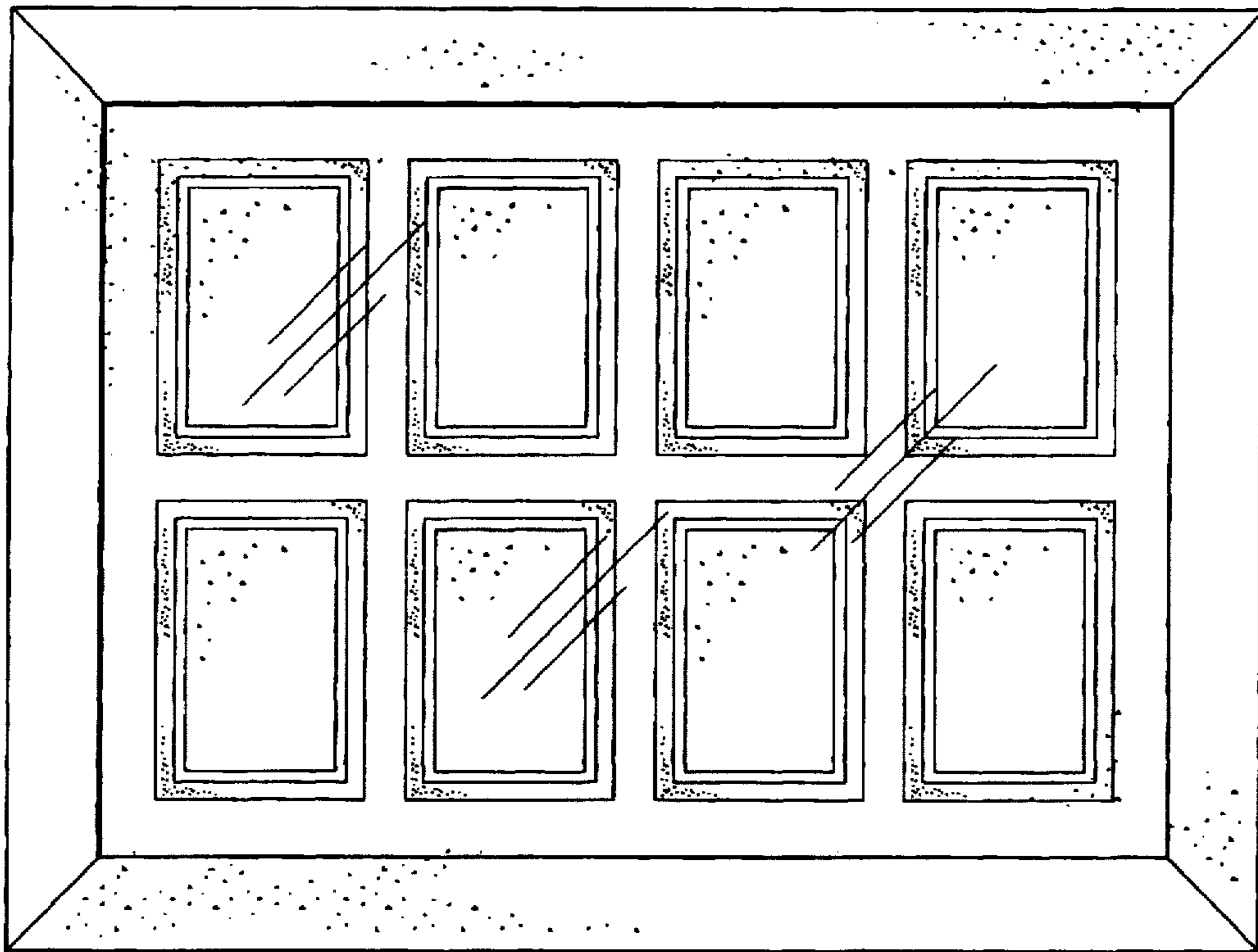

FIG. 2

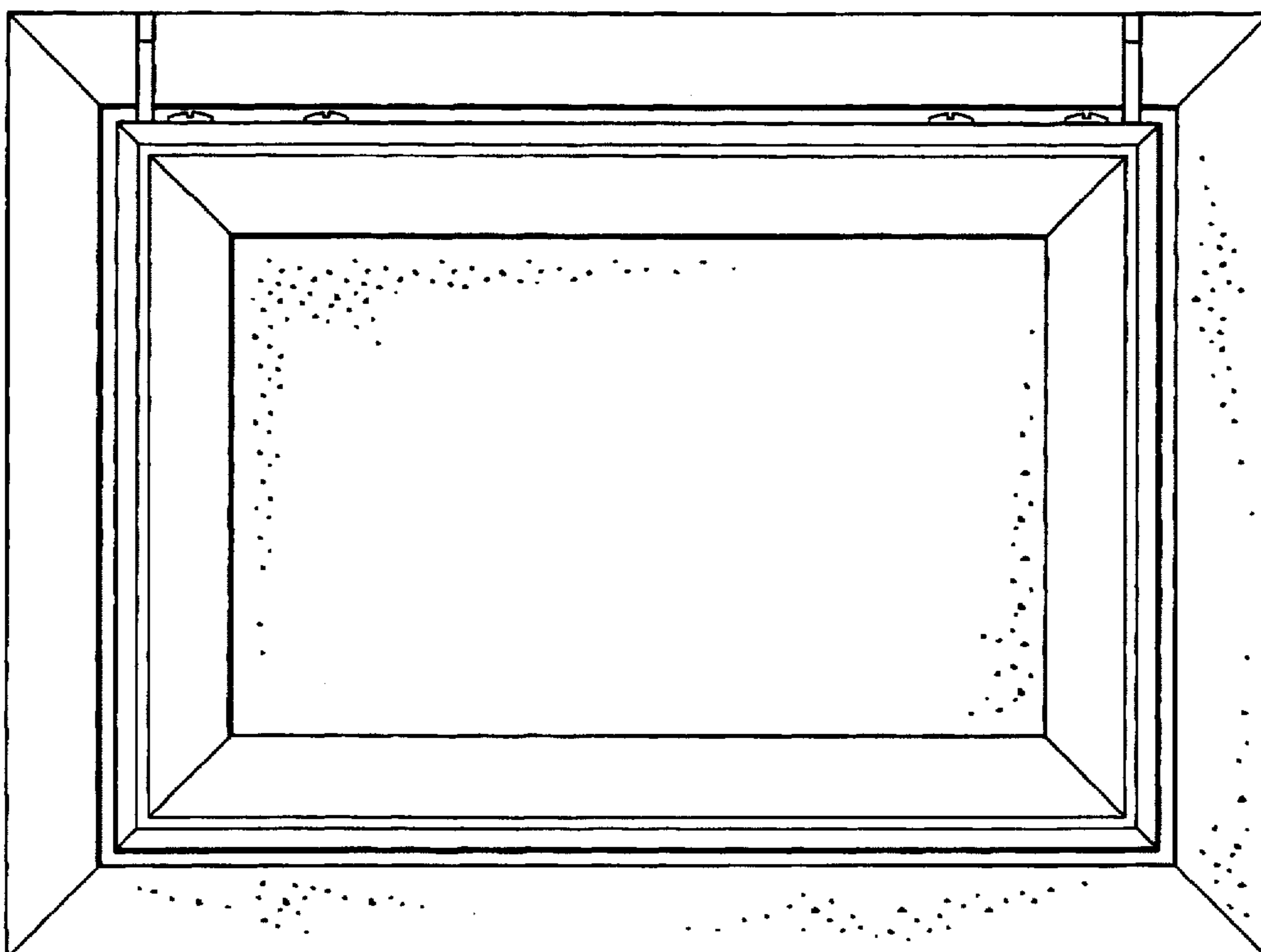

FIG. 3

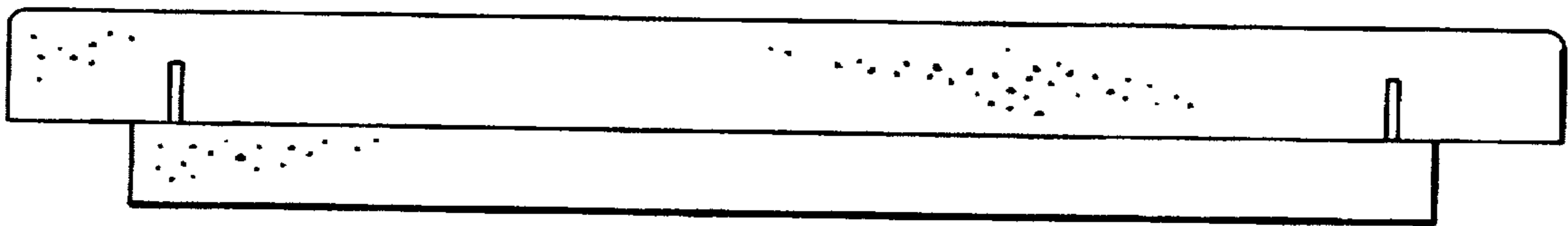

FIG. 4

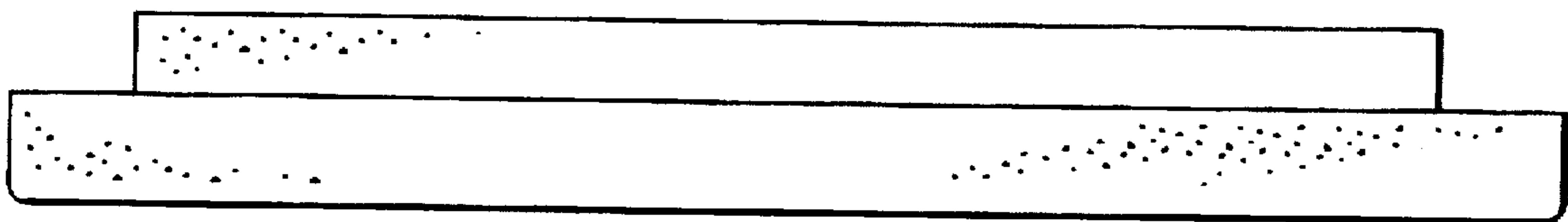

FIG. 5

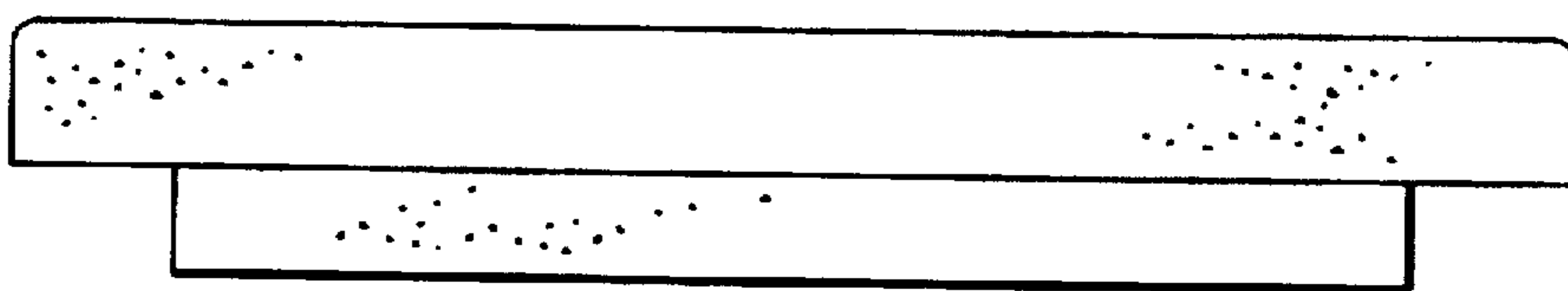

FIG. 6

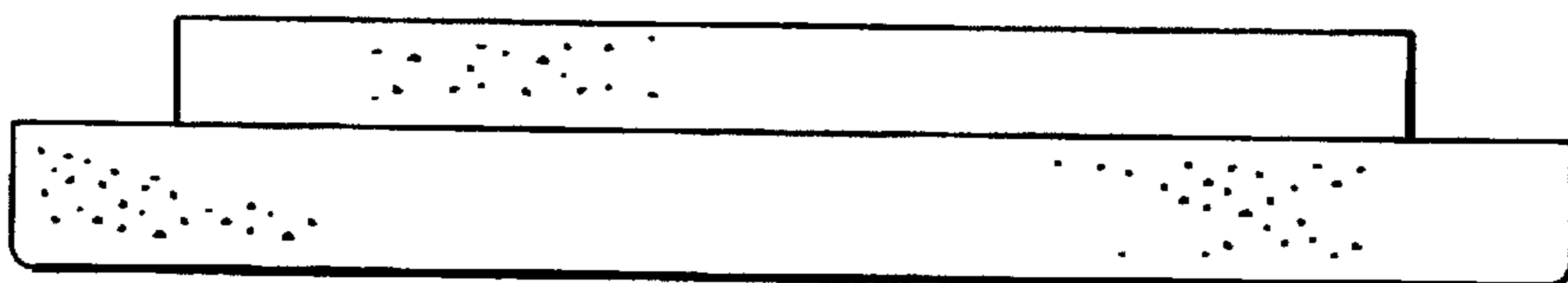

FIG. 7

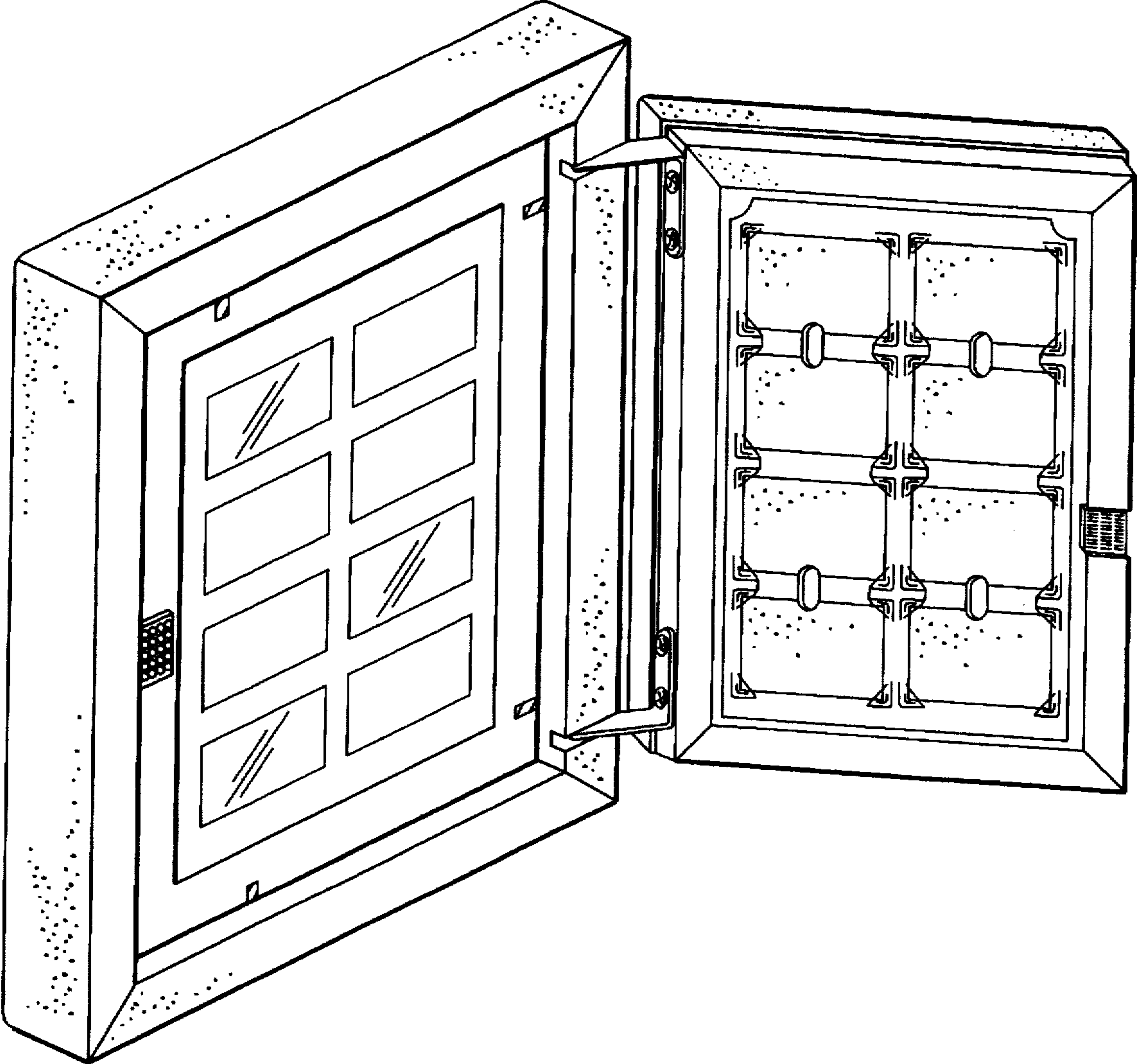

FIG. 8

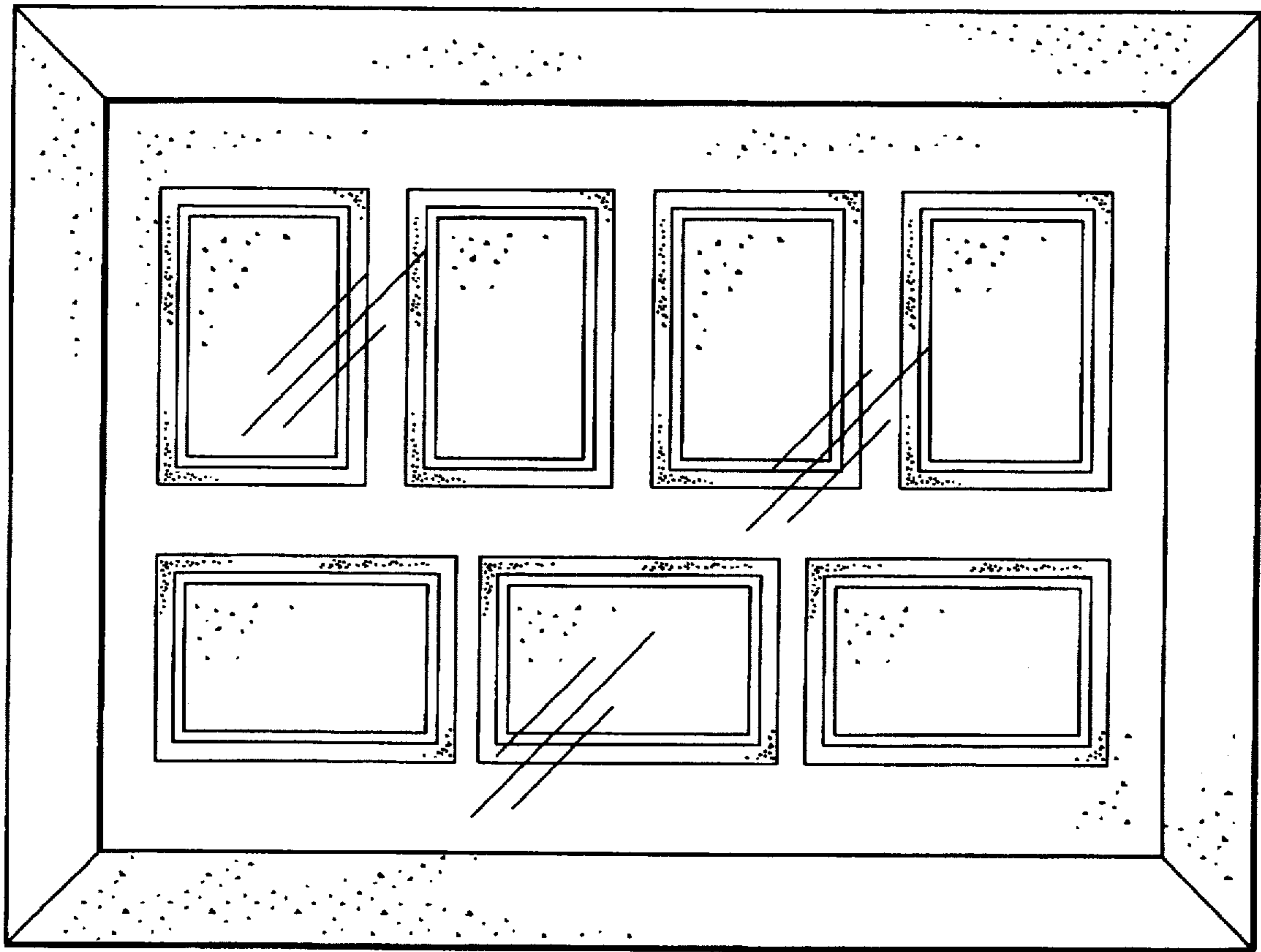

FIG. 9

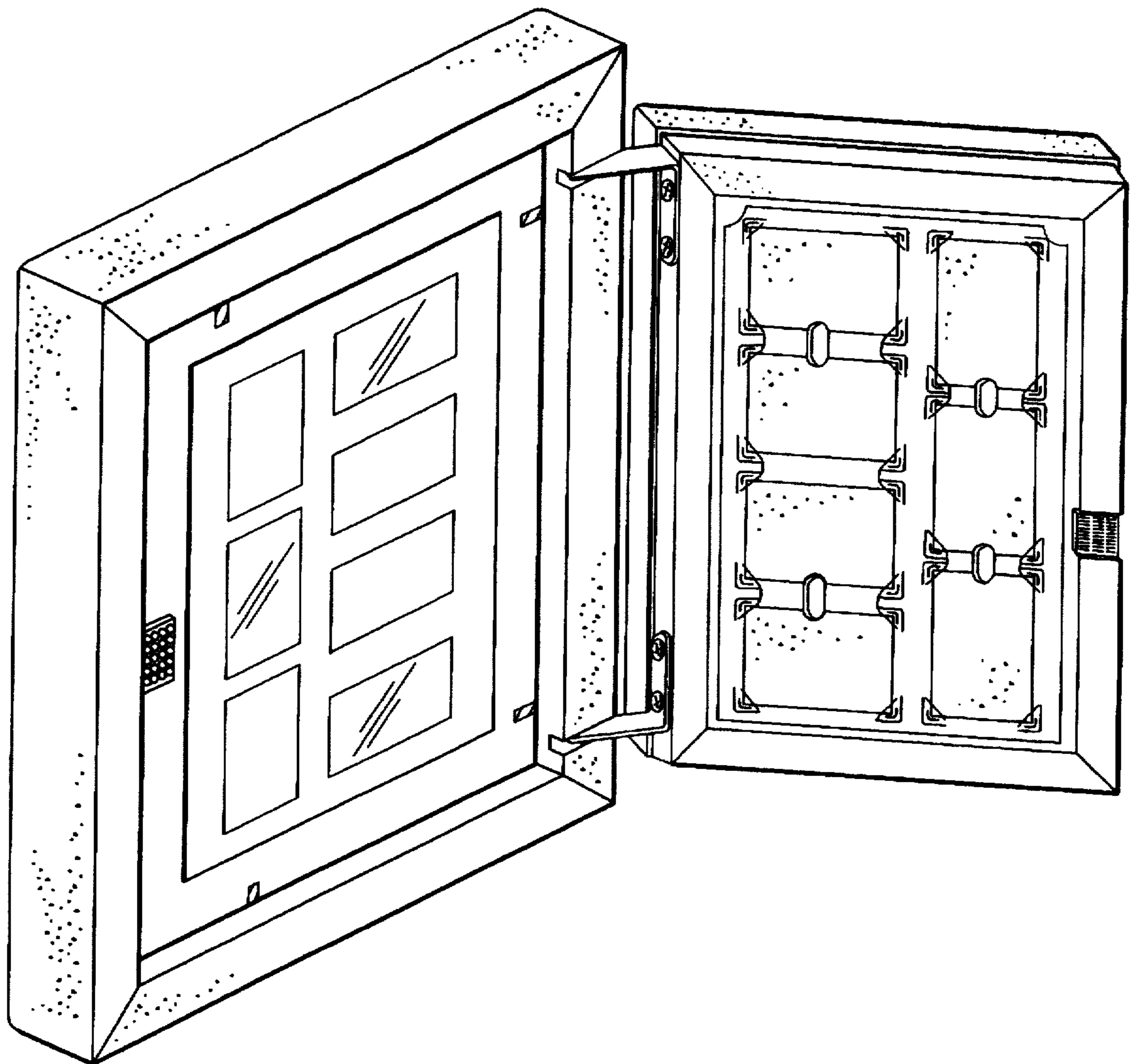

FIG. 10

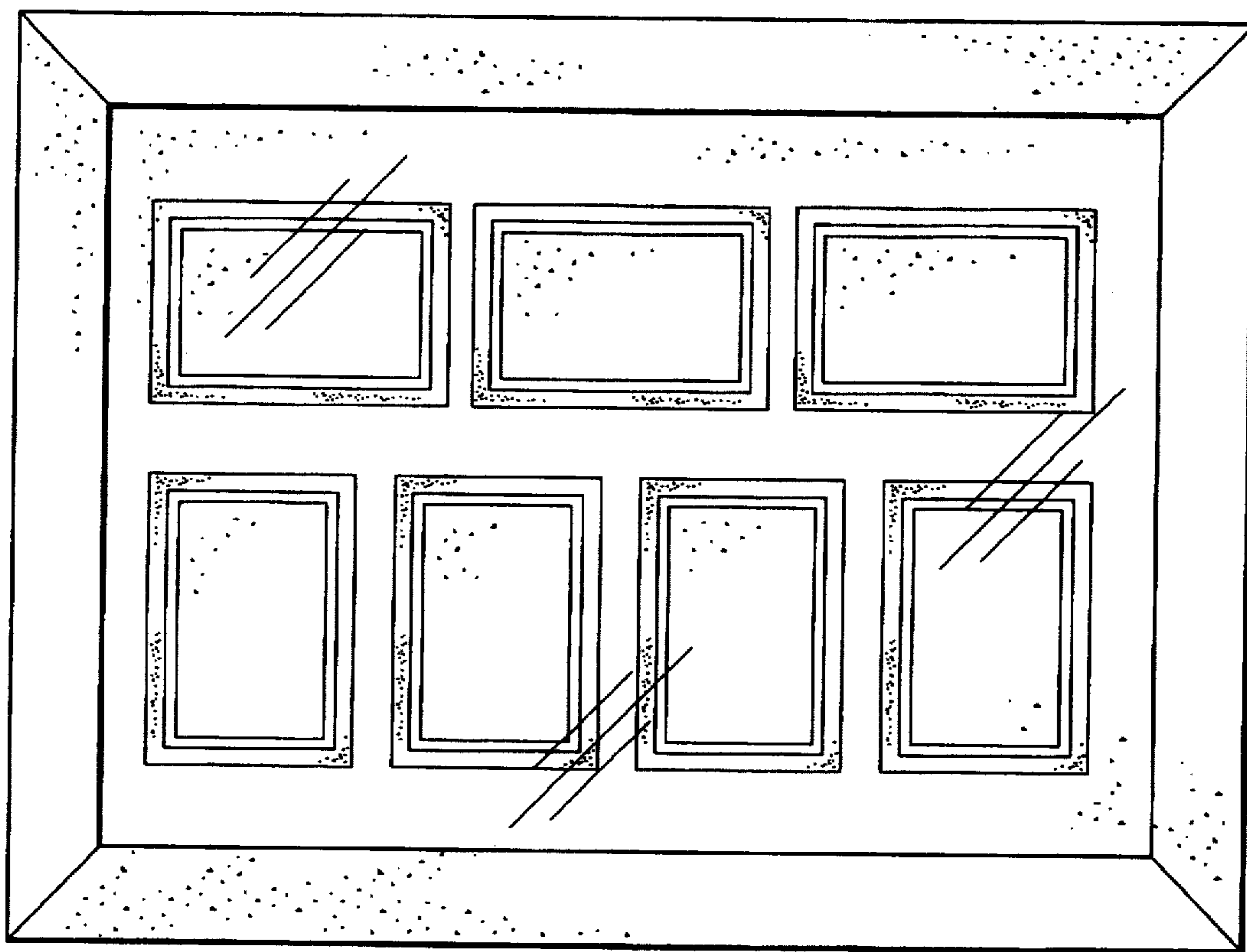

FIG. 11

