



US00D408133S

# United States Patent [19]

Francis et al.

[11] Patent Number: Des. 408,133

[45] Date of Patent: \*\*Apr. 20, 1999

[54] **BACKPACK**

[76] Inventors: **Gregory H. Francis**, 2004 Stillwell Ct., Murfreesboro, Tenn. 37130; **Walter L. Toney**, 140 Saxon Mist Dr., Nashville, Tenn. 37217; **Charles O. Morton**, 1272 John Sharp Rd., Spring Hill, Tenn. 37174

[\*\*] Term: **14 Years**

[21] Appl. No.: **29/071,516**

[22] Filed: **May 30, 1997**

[51] **LOC (6) Cl.** ..... **03-01**

[52] **U.S. Cl.** ..... **D3/214**

[58] **Field of Search** ..... D3/214, 216, 217, D3/231, 253; D12/409; 224/153, 579, 583, 627, 653; 190/103, 110, 18 A; D7/605, 606, 607, 608

[56] **References Cited**

**U.S. PATENT DOCUMENTS**

D. 284,620 7/1986 Calton ..... D3/217 X

D. 360,182 7/1995 Lovett ..... D12/409  
4,673,117 6/1987 Calton ..... 224/153 X  
5,405,068 4/1995 Lovett ..... 224/153  
5,743,447 4/1998 McDermott ..... 224/153

*Primary Examiner*—Louis S. Zarfes  
*Assistant Examiner*—Catherine R. Oliver  
*Attorney, Agent, or Firm*—Waddey & Patterson; Edward D. Lanquist, Jr.

[57] **CLAIM**

The ornamental design for a backpack, as shown and described.

**DESCRIPTION**

FIG. 1 is a front elevational view of the backpack showing our new design;  
FIG. 2 is a right side elevational view thereof;  
FIG. 3 is a rear elevational view thereof;  
FIG. 4 is a left side view thereof;  
FIG. 5 is a bottom plan view thereof; and,  
FIG. 6 is a top plan view thereof.

**1 Claim, 2 Drawing Sheets**

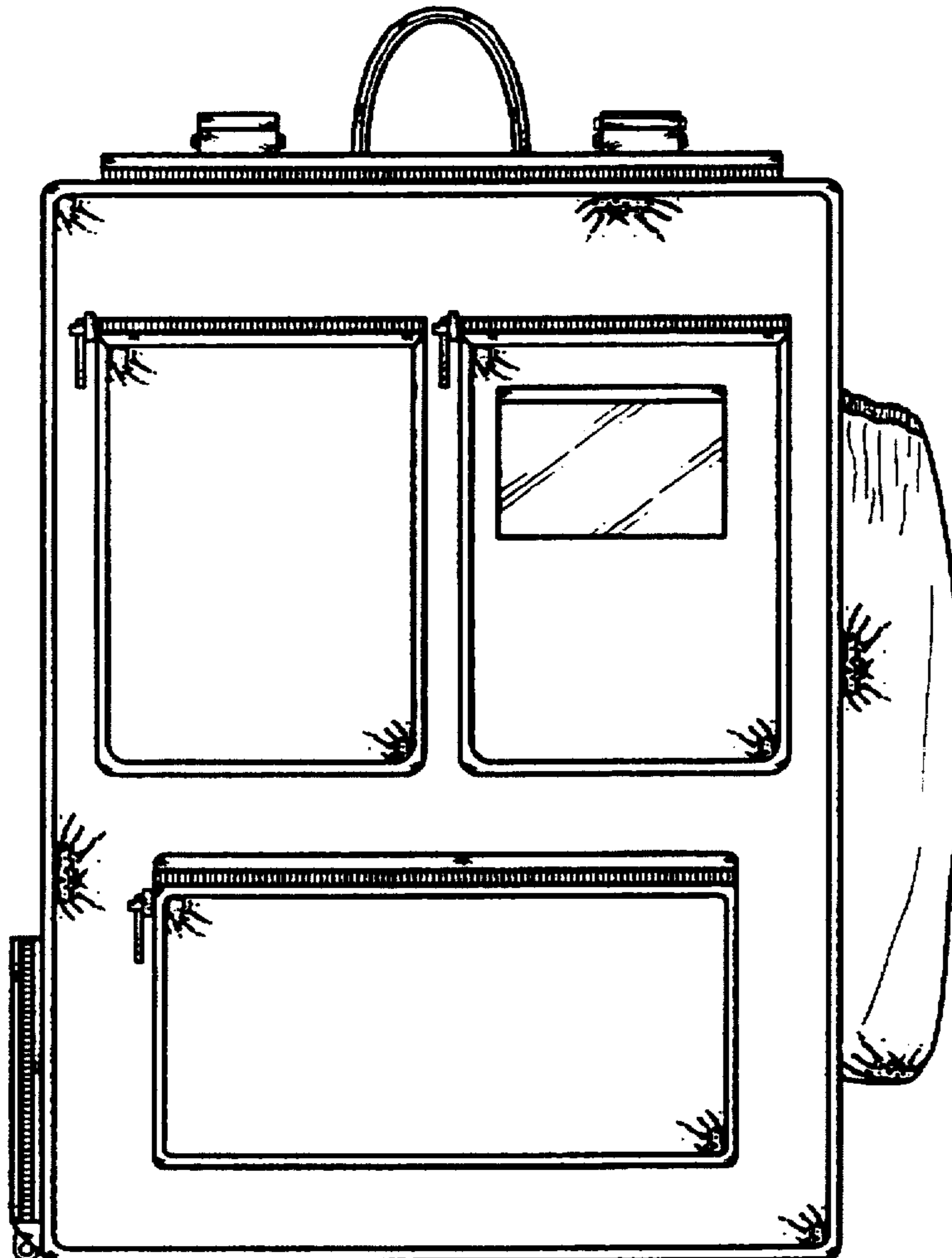

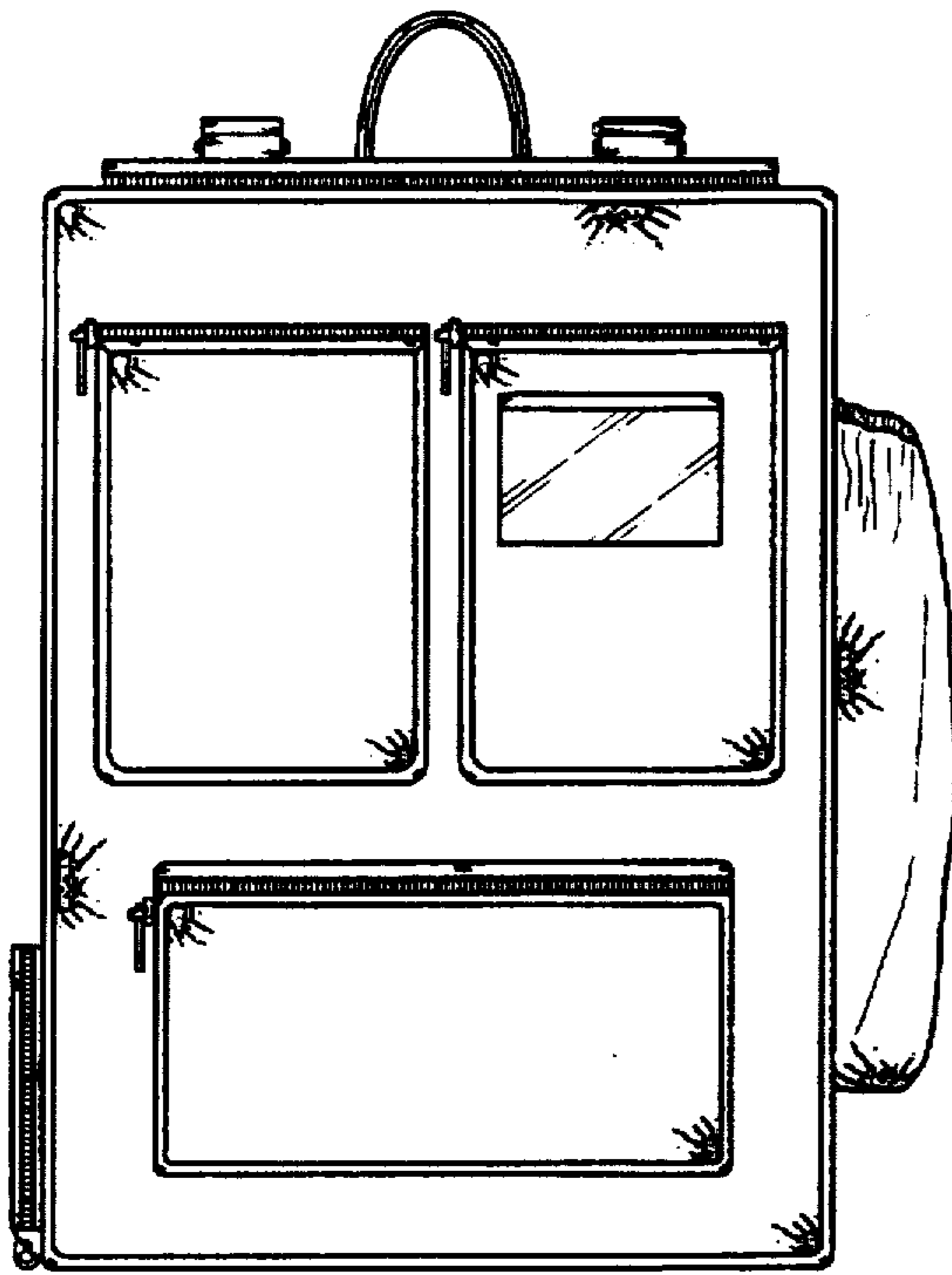

FIG. 1

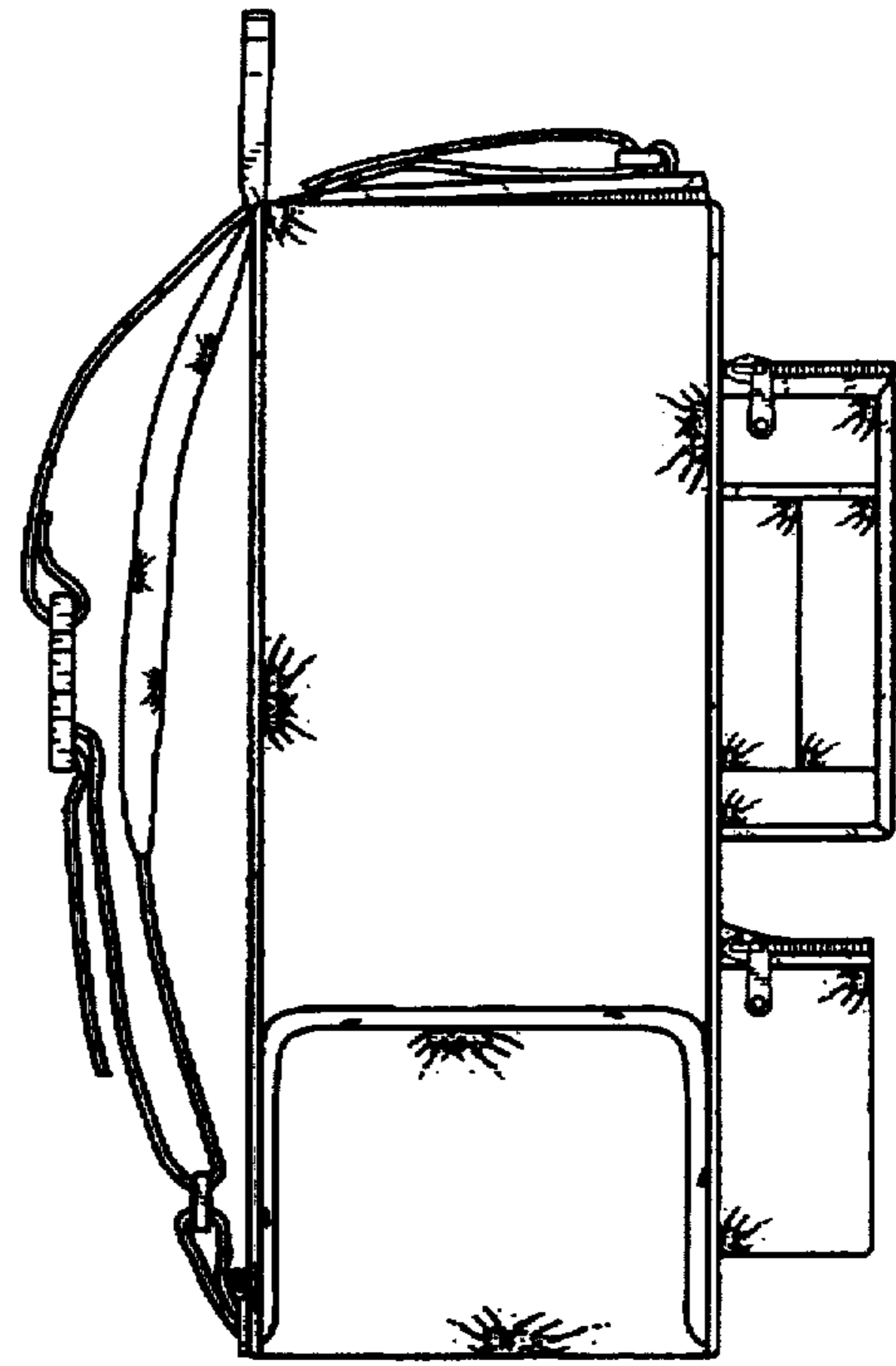

FIG. 2

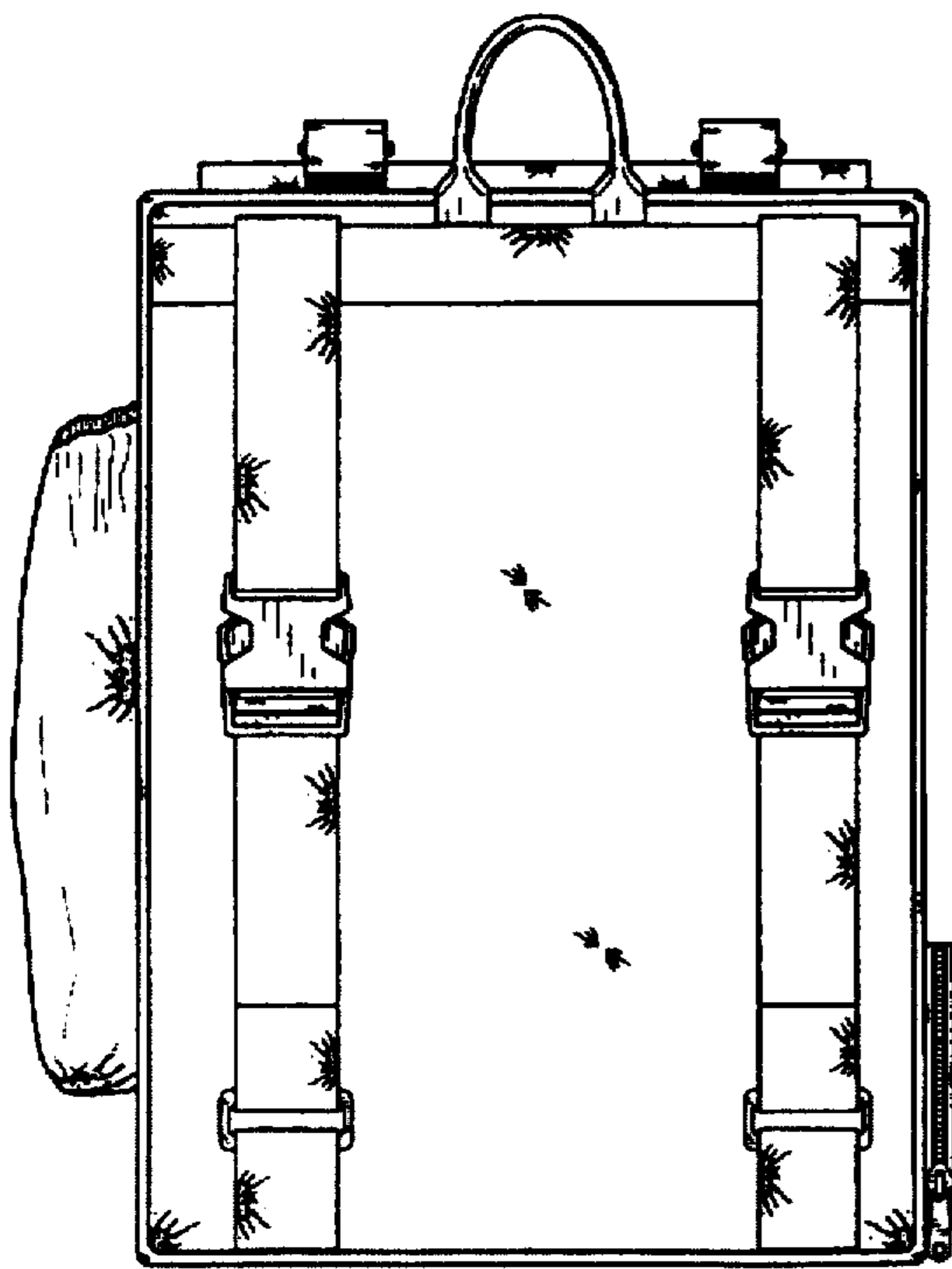

FIG. 3

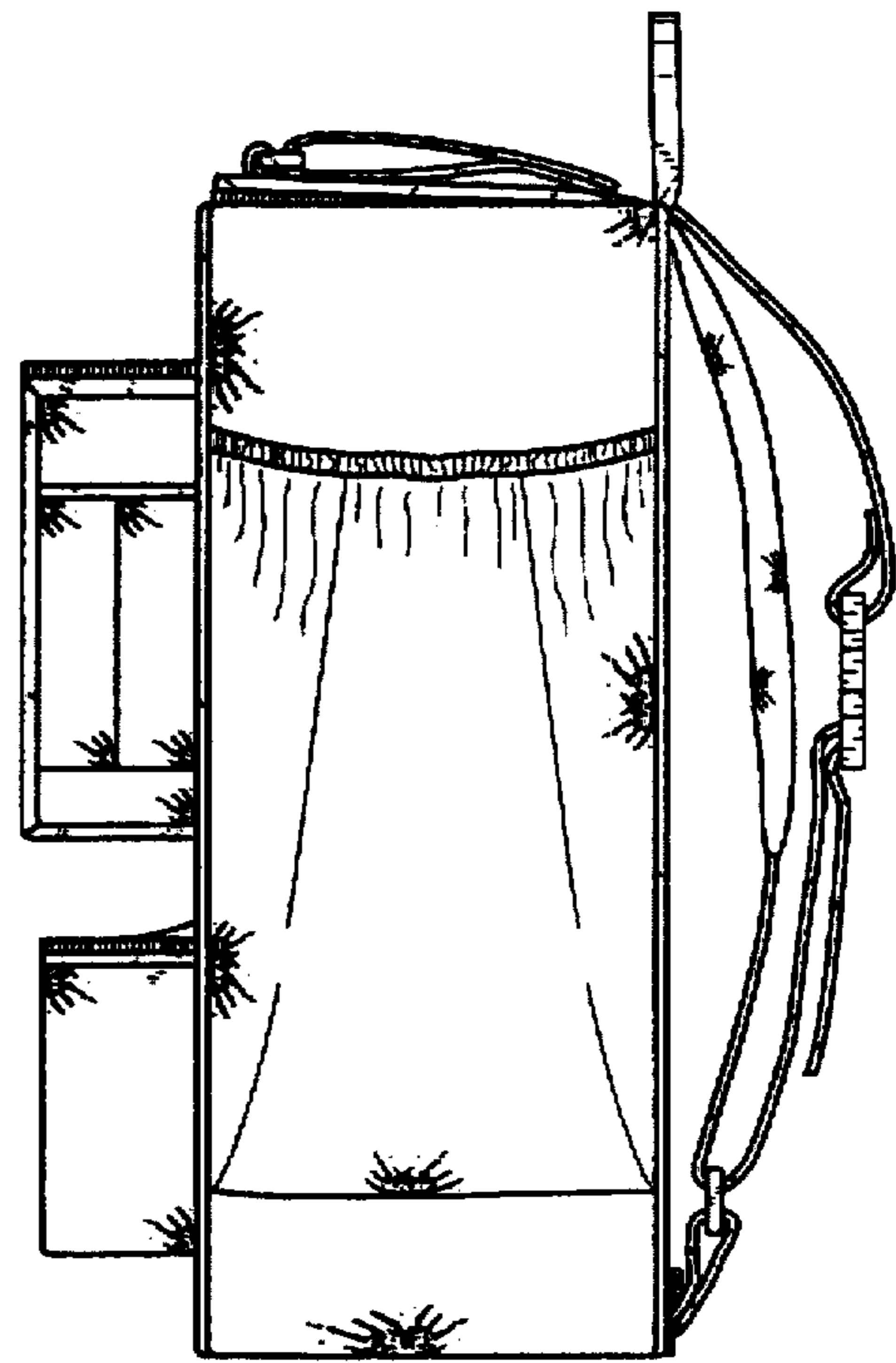
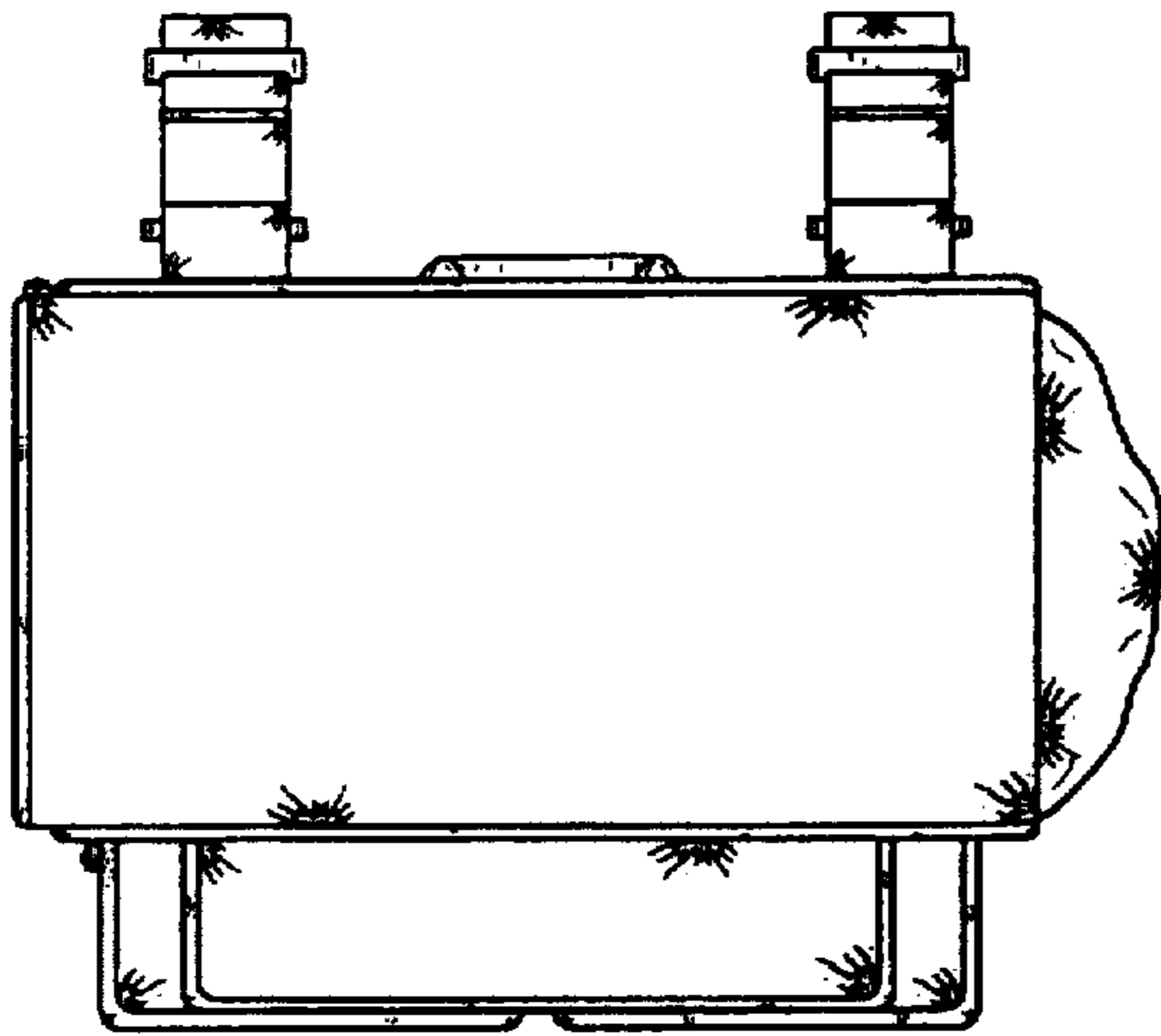
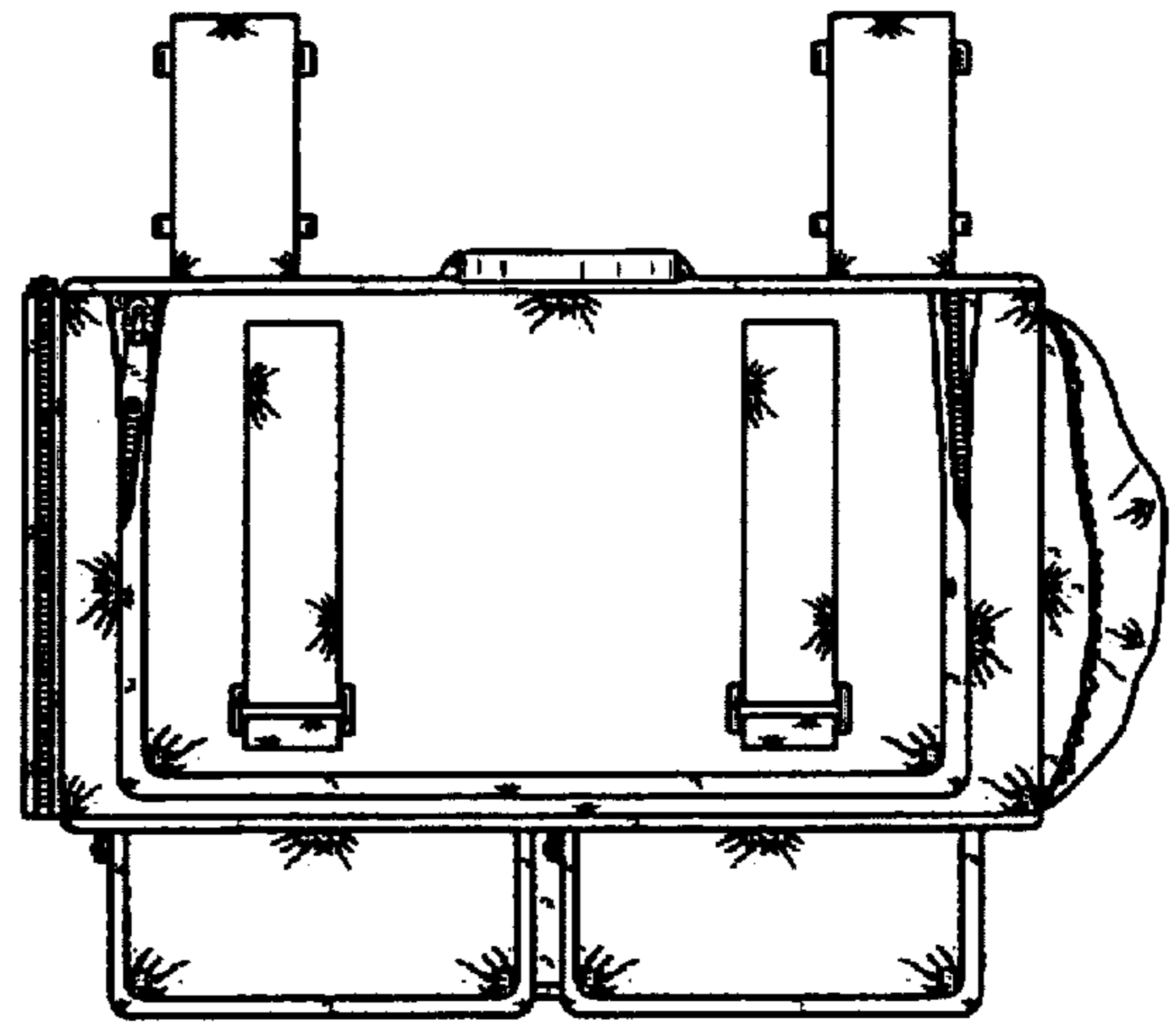

FIG. 4



*FIG. 5*



*FIG. 6*