



US00D408076S

# United States Patent [19]

[11] Patent Number: **Des. 408,076**

Zuege

[45] Date of Patent: **\*\*Apr. 13, 1999**

[54] **COMBINED MOTOR HOUSING, SWITCH HOUSING AND BLADE IRONS UNIT FOR A CEILING FAN**

[75] Inventor: **Bradford C. Zuege, Memphis, Tenn.**

[73] Assignee: **Hunter Fan Company, Memphis, Tenn.**

[\*\*] Term: **14 Years**

[21] Appl. No.: **29/091,024**

[22] Filed: **Jul. 22, 1998**

[51] LOC (6) Cl. .... **23-04**

[52] U.S. Cl. .... **D23/411; D23/377; D23/385**

[58] Field of Search ..... **D23/377, 379, D23/385, 411; 416/5; 392/364; 362/96; D26/51, 59, 72, 81-86, 88**

### [56] References Cited

#### U.S. PATENT DOCUMENTS

- D. 326,905 6/1992 Scofield ..... D23/411
- D. 393,711 4/1998 Gee, II et al. .... D23/411

#### OTHER PUBLICATIONS

Winnower Fan Company Inc., Ceiling Fan (A).  
Hunter Fan Co. Catalog Sheet, Copyright 1997, 52" Preference.

Primary Examiner—Lisa Lichtenstein  
Attorney, Agent, or Firm—Baker, Donelson, Bearman & Caldwell

### [57] CLAIM

The ornamental design of a combined motor housing, switch housing and blade irons unit for a ceiling fan, as shown and described.

### DESCRIPTION

FIG. 1 is a perspective view of a combined motor housing, switch housing and blade irons unit for a ceiling fan showing my new design;

FIG. 2 is a perspective view of the design shown in FIG. 1 with the environmental structure removed therefrom;

FIG. 3 is a front view thereof;

FIG. 4 is a right-side view thereof;

FIG. 5 is a rear view thereof;

FIG. 6 is a left-side view thereof;

FIG. 7 is a top view thereof;

FIG. 8 is a bottom view thereof;

FIG. 9 is a perspective view of a second embodiment of the design shown in FIGS. 1-8;

FIG. 10 is a front view of FIG. 9;

FIG. 11 is a right-side view of FIG. 9;

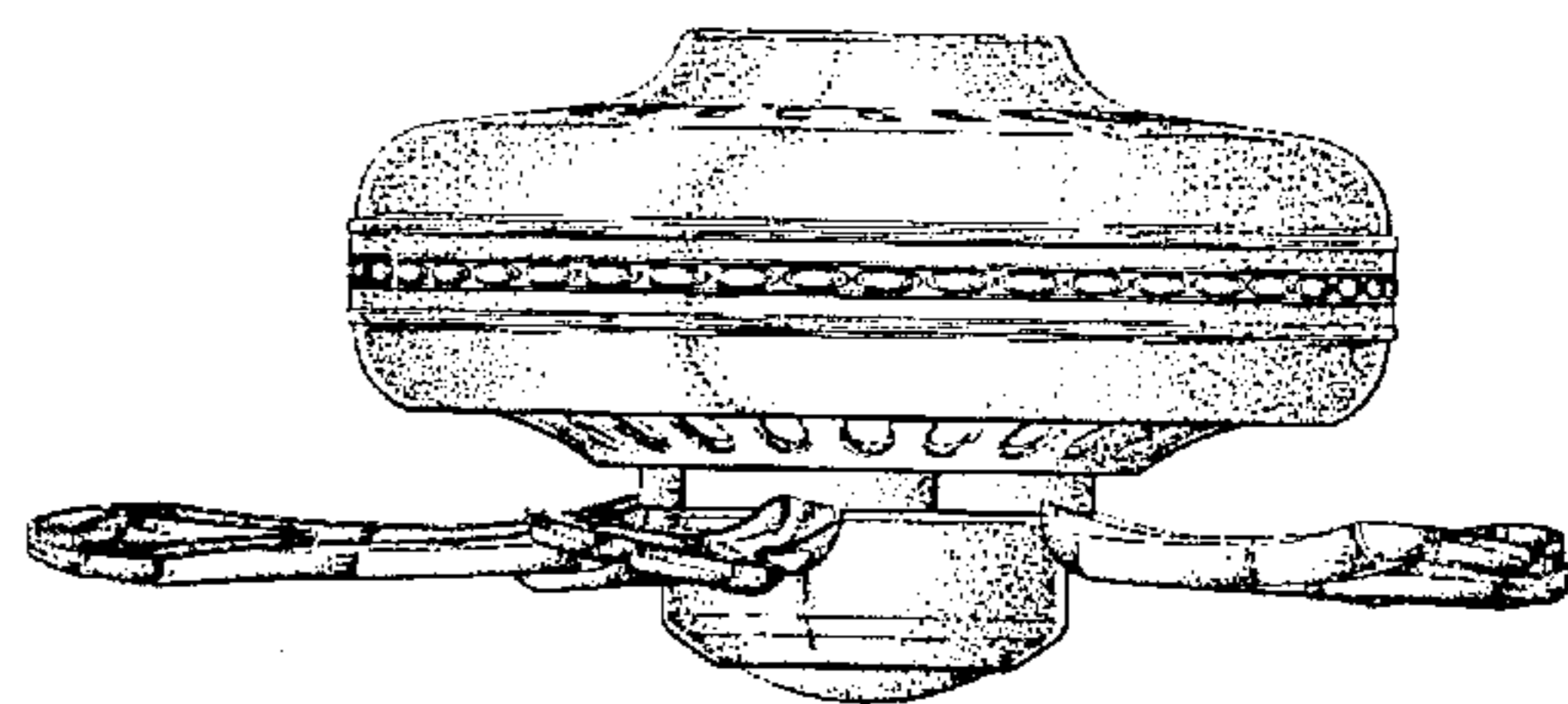
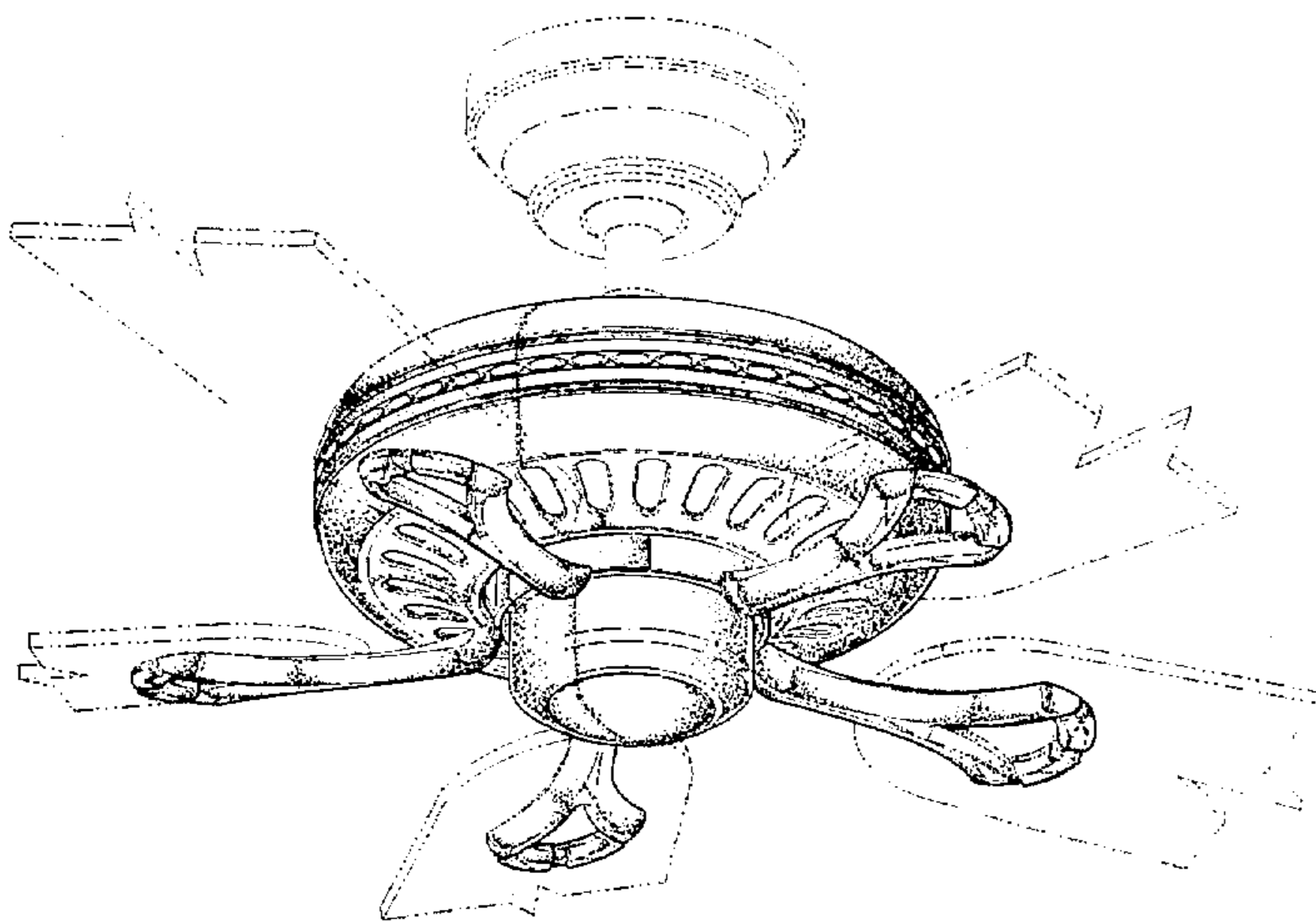
FIG. 12 is a rear view of FIG. 9;

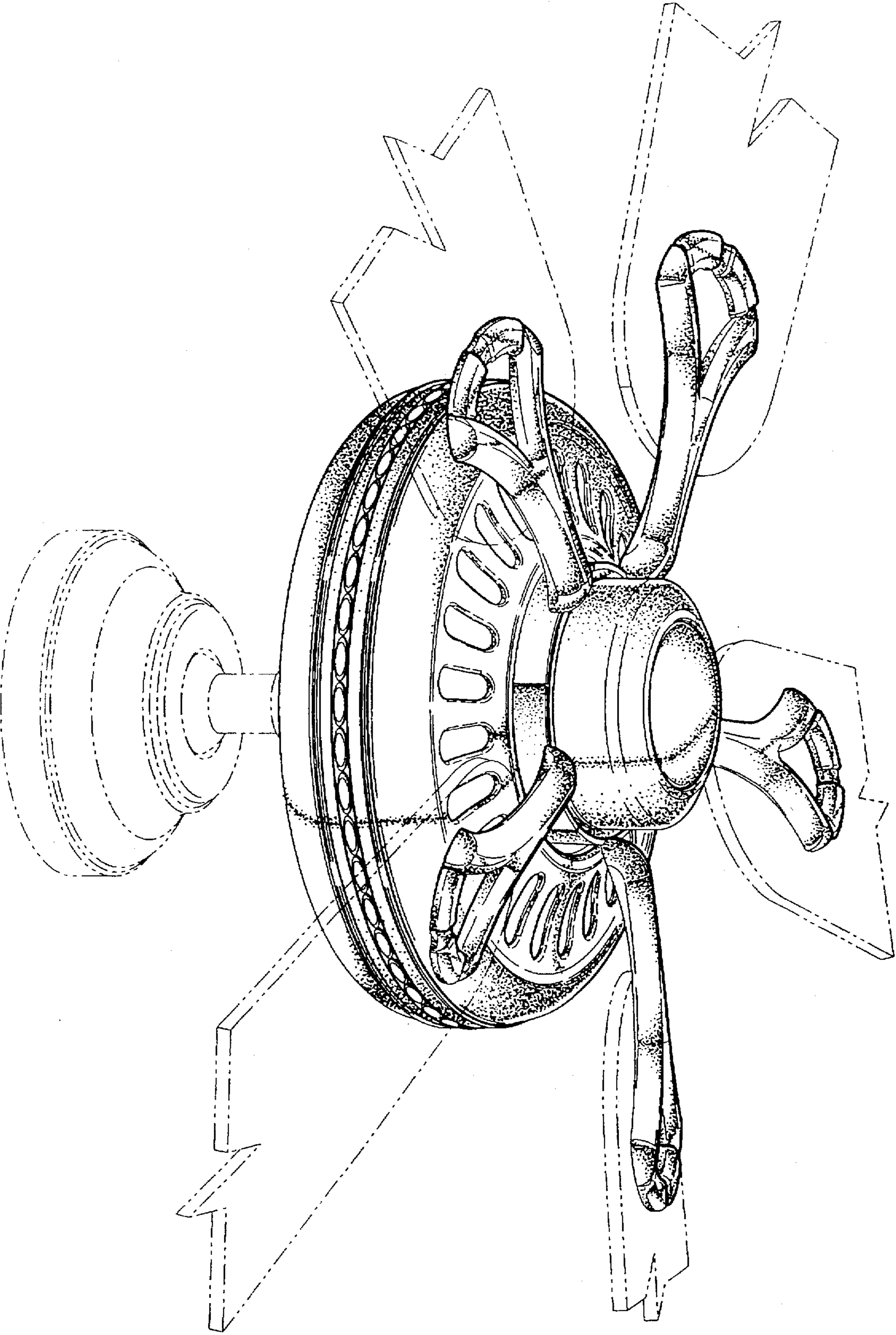
FIG. 13 is a left-side view of FIG. 9; and,

FIG. 14 is a top view of FIG. 9, the bottom view being identical to the bottom view illustrated in FIG. 8.

The broken-line showing of environmental structure in FIG. 1 is for illustrative purposes only and forms no part of the claimed design.

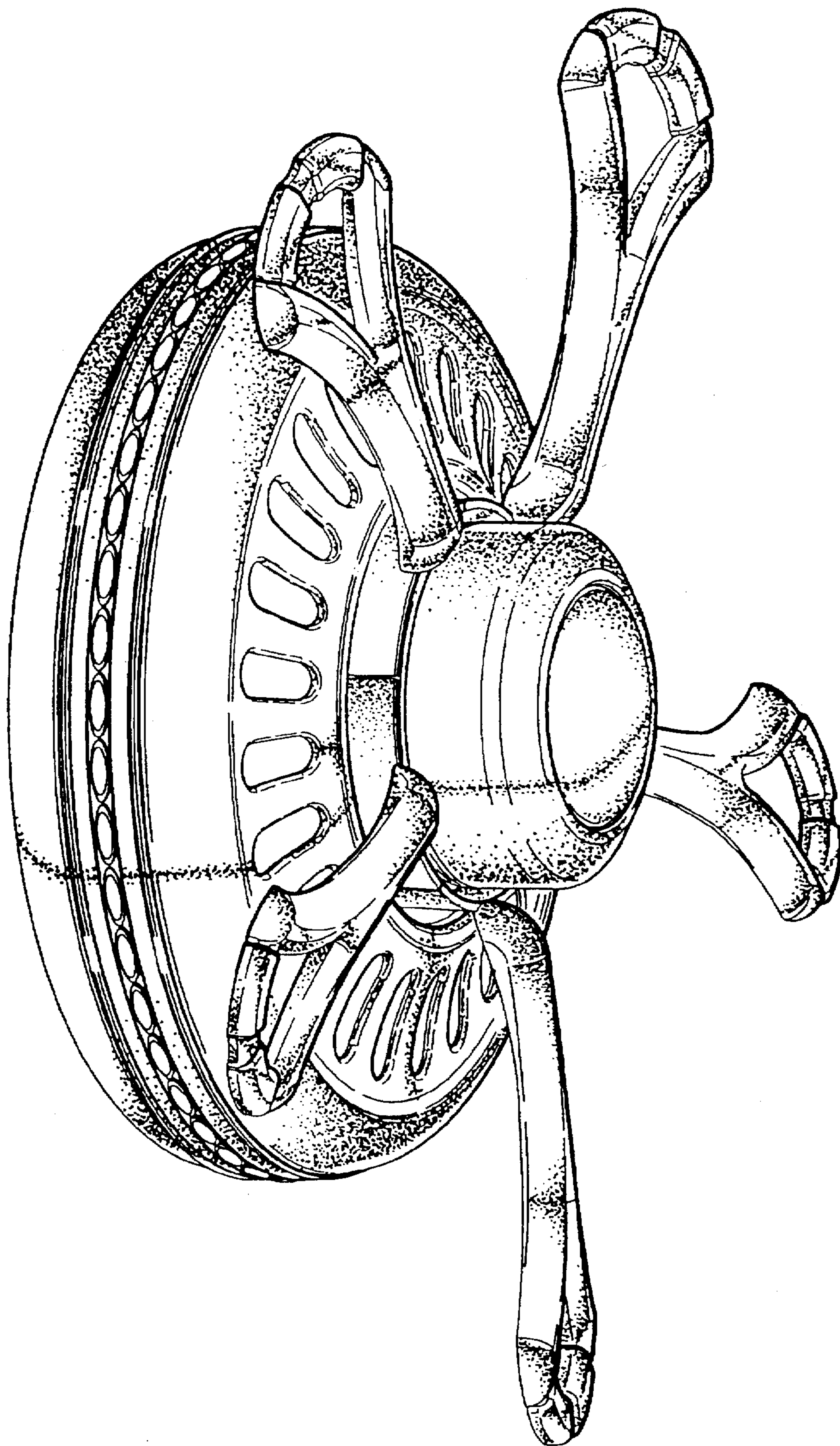
**1 Claim, 14 Drawing Sheets**



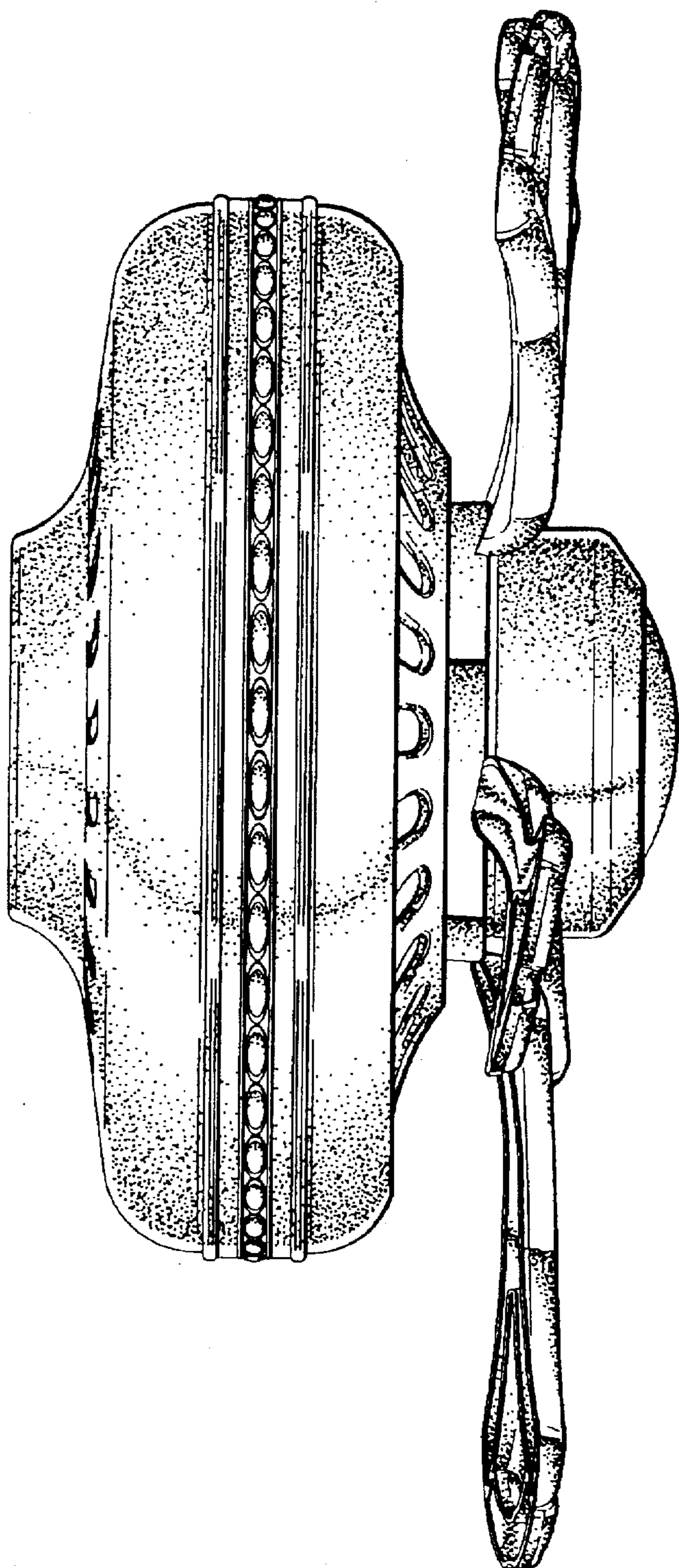


**FIG 1**

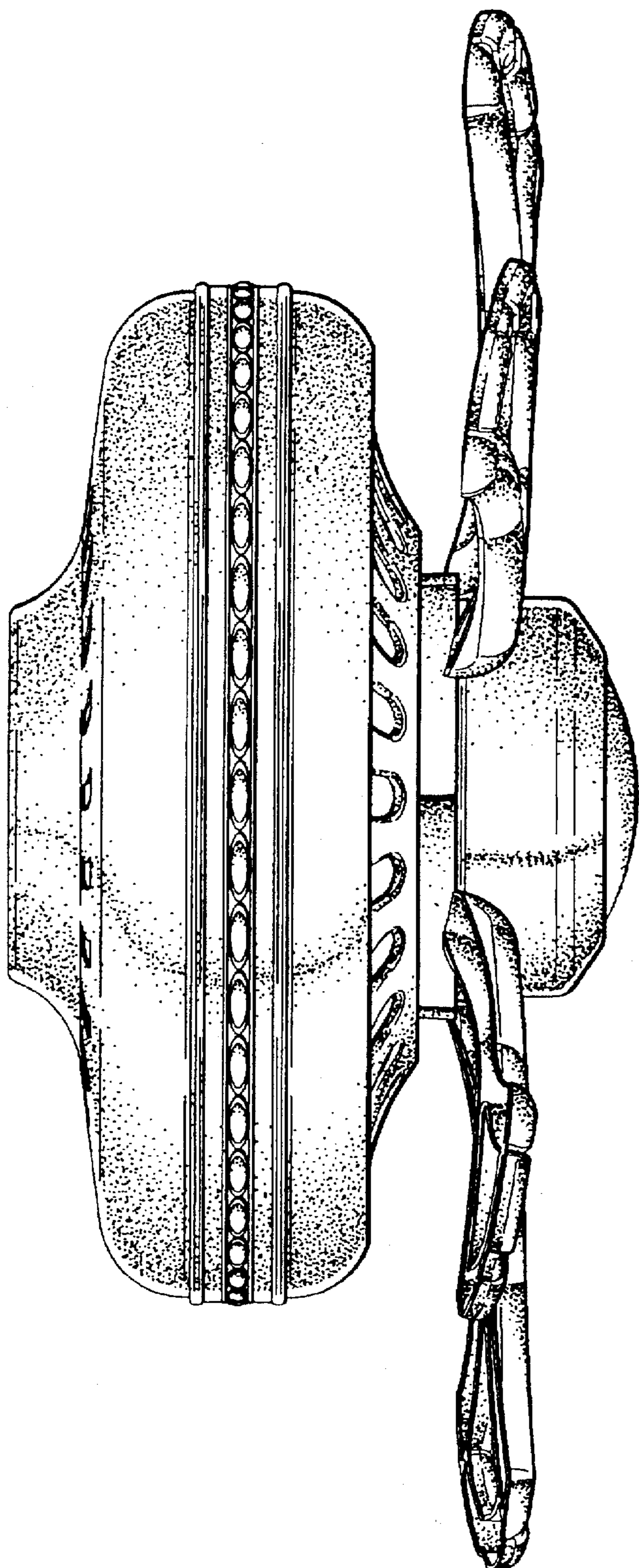




**FIG 2**

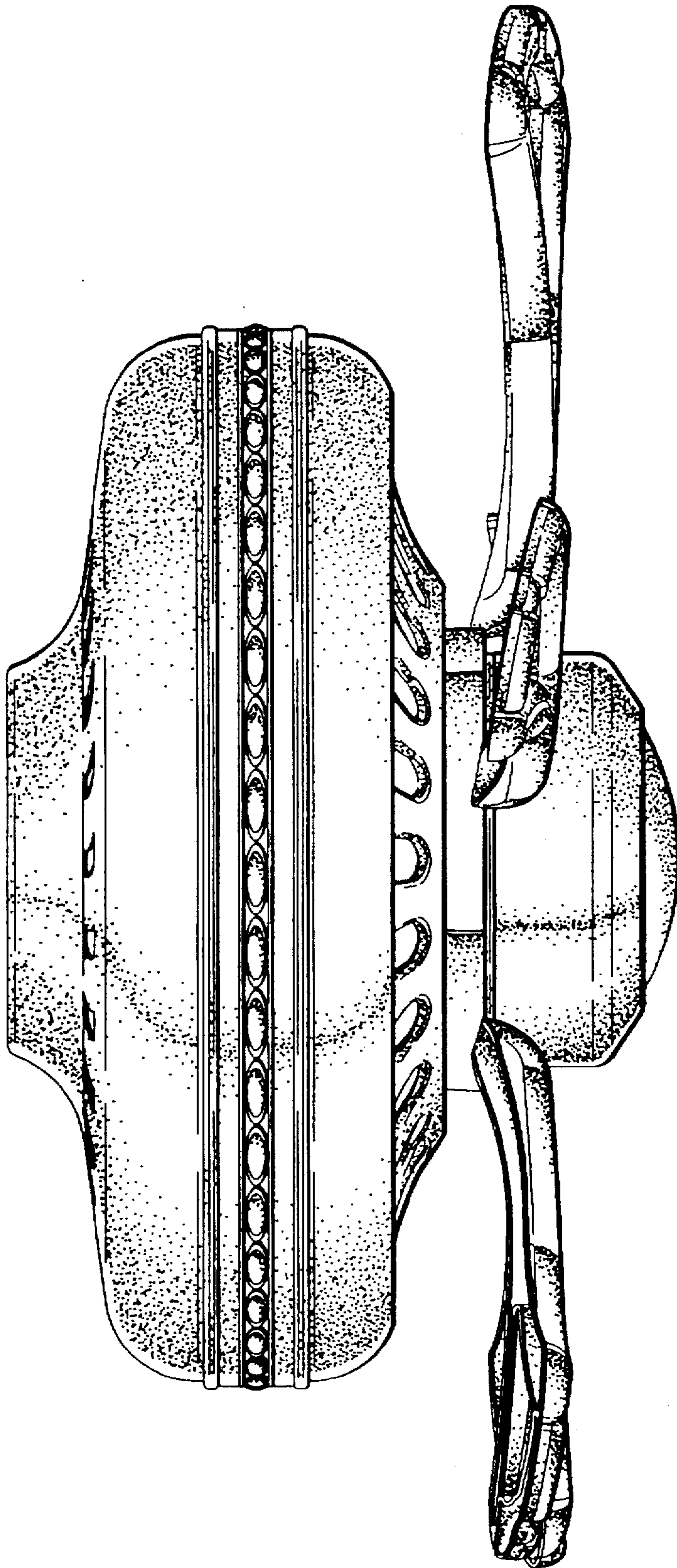


**FIG 3**

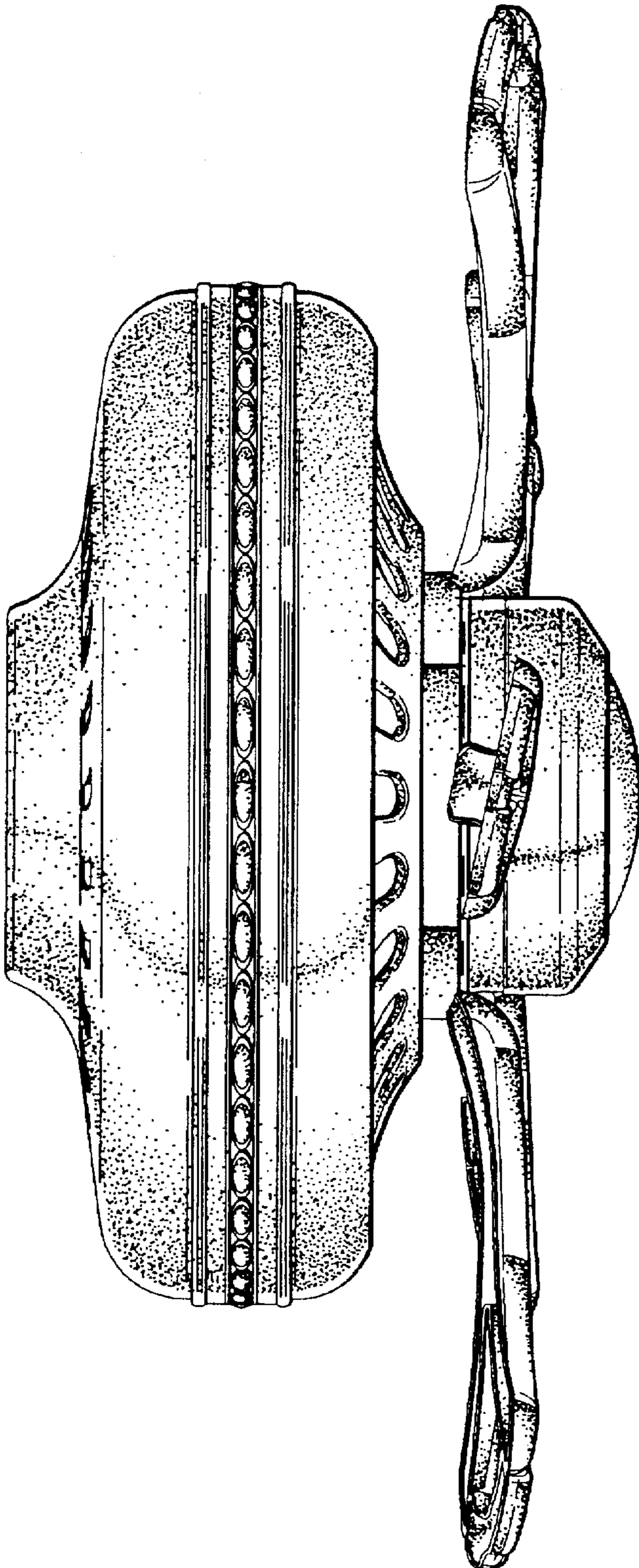


**FIG 4**

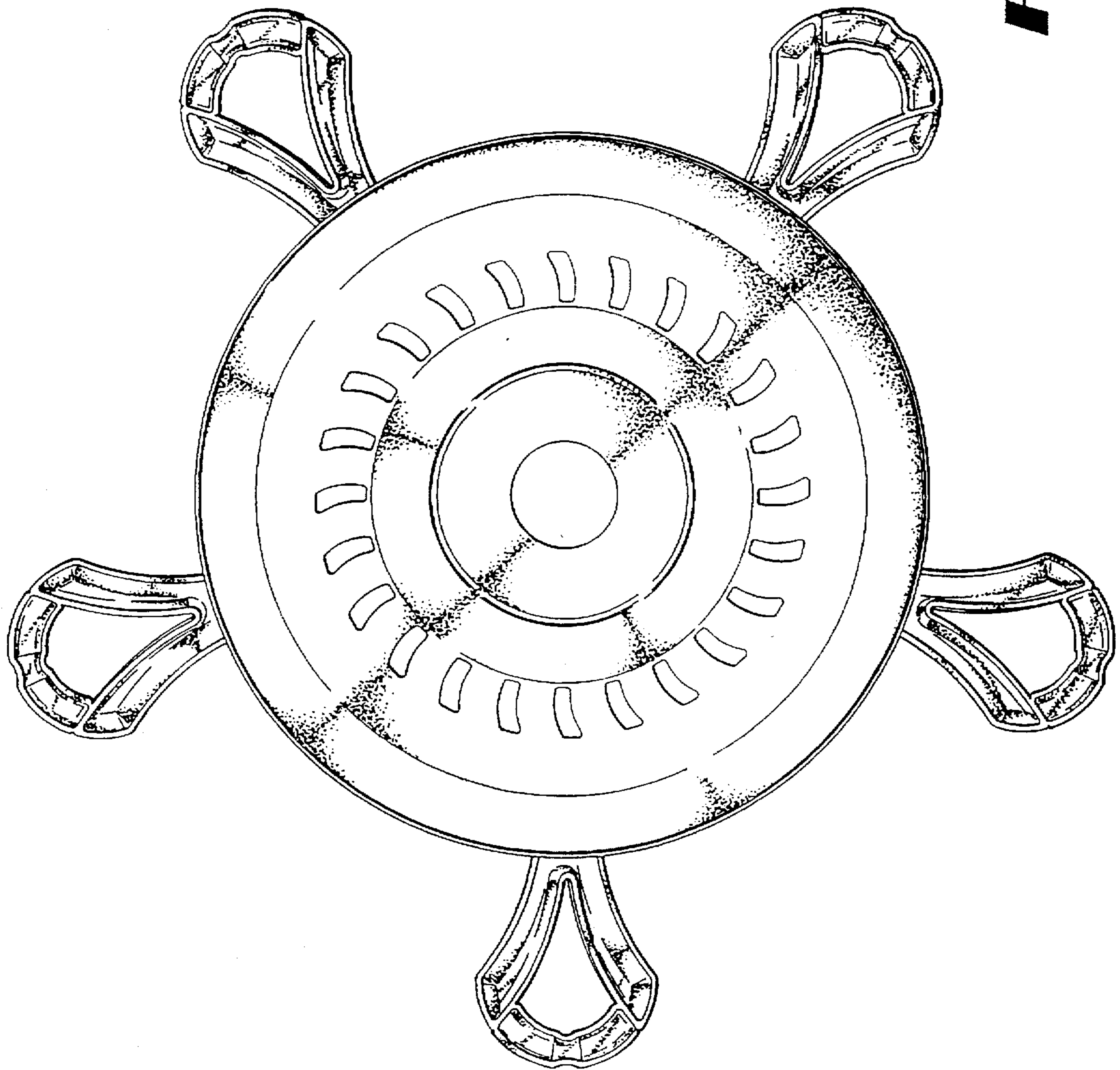




**FIG 5**

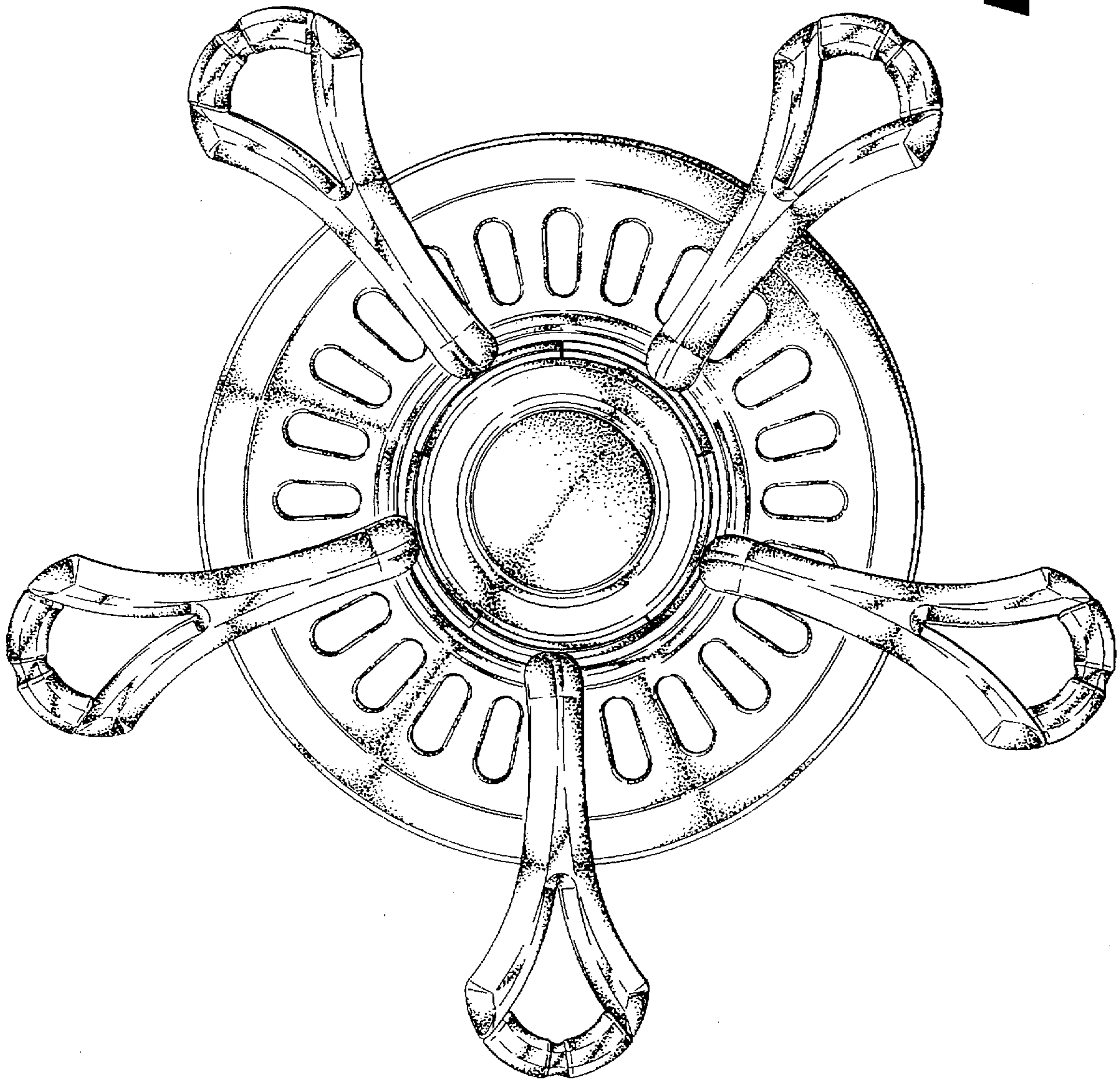


**FIG 6**

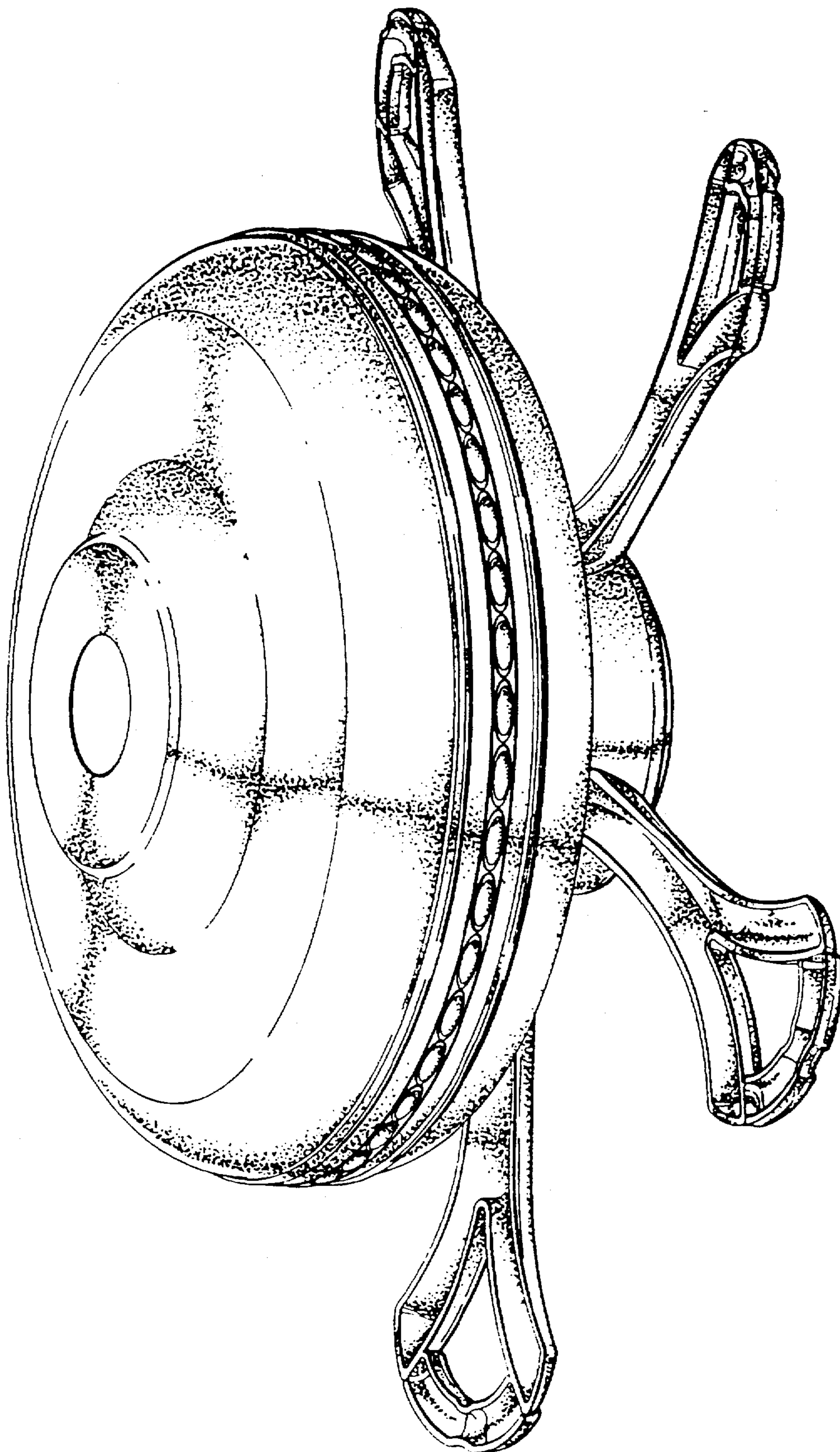


**FIG 7**



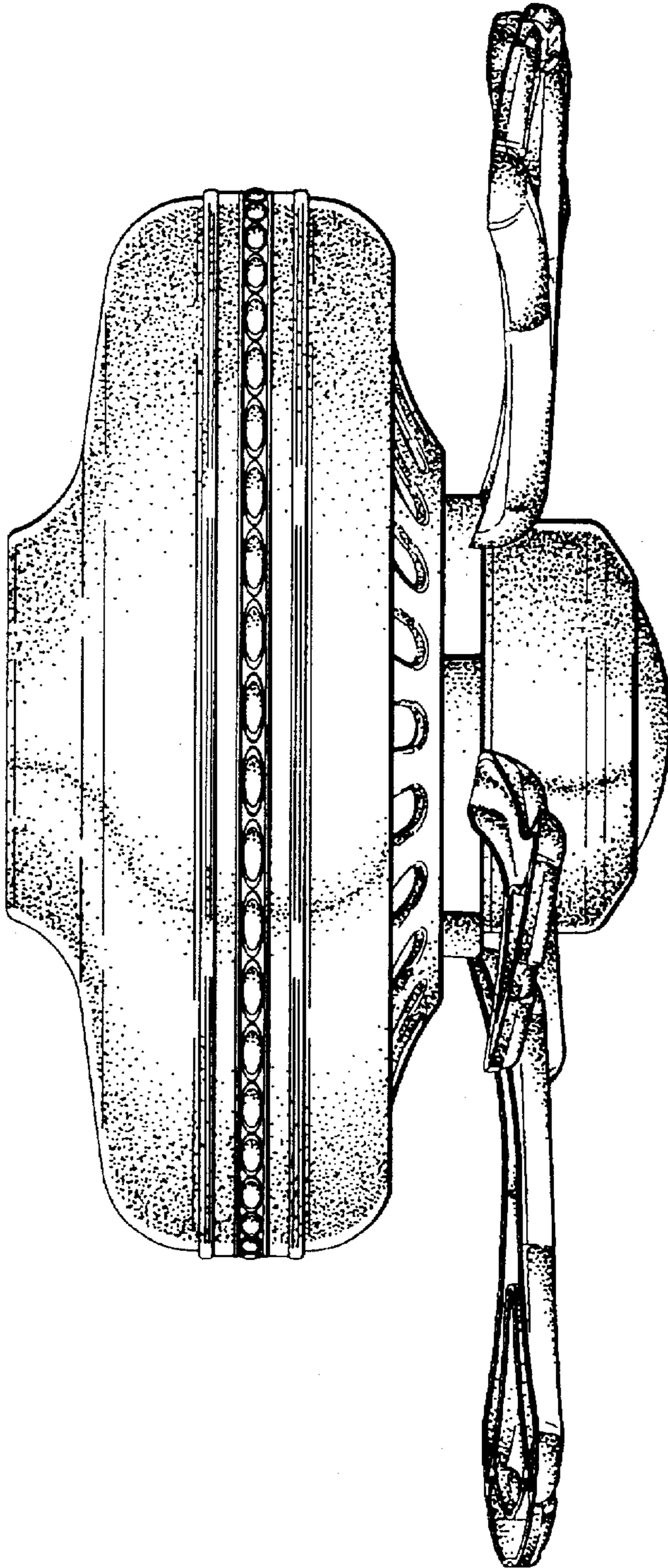


**FIG 8**

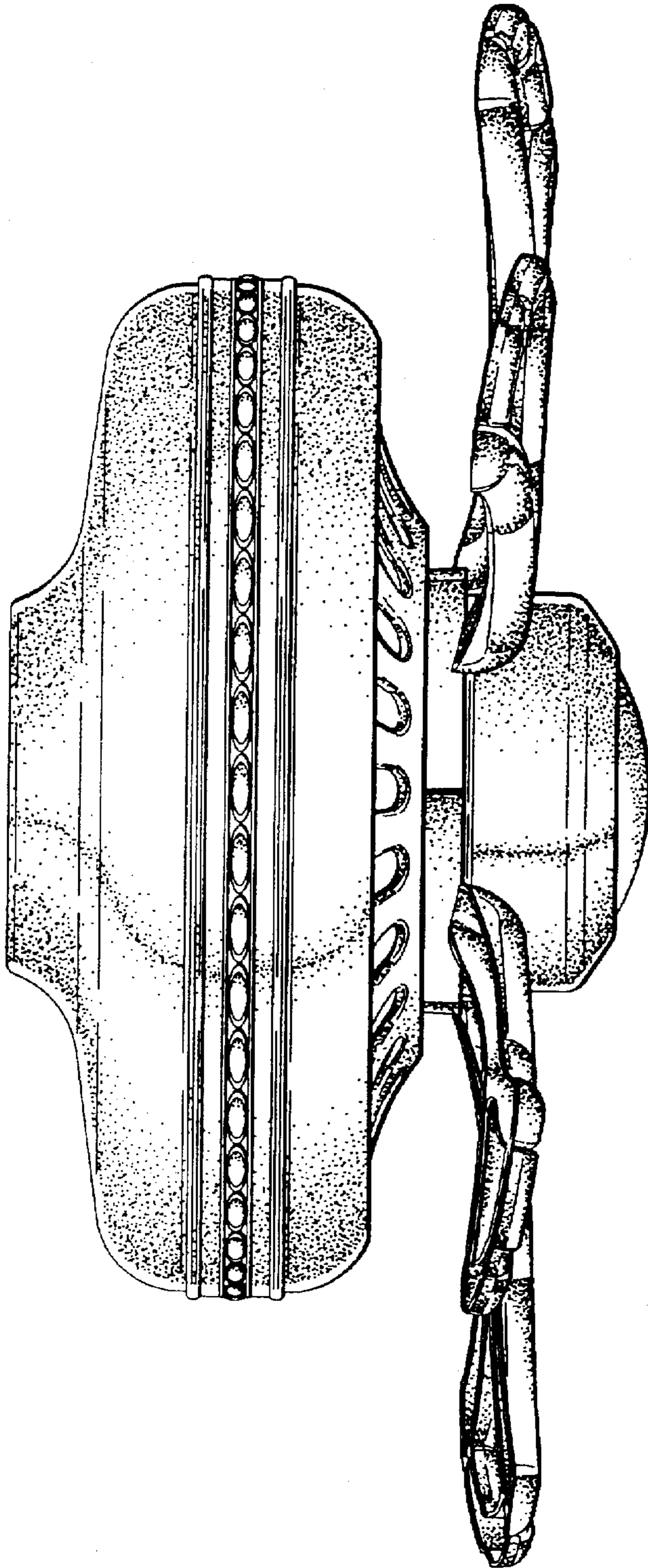


**FIG 9**

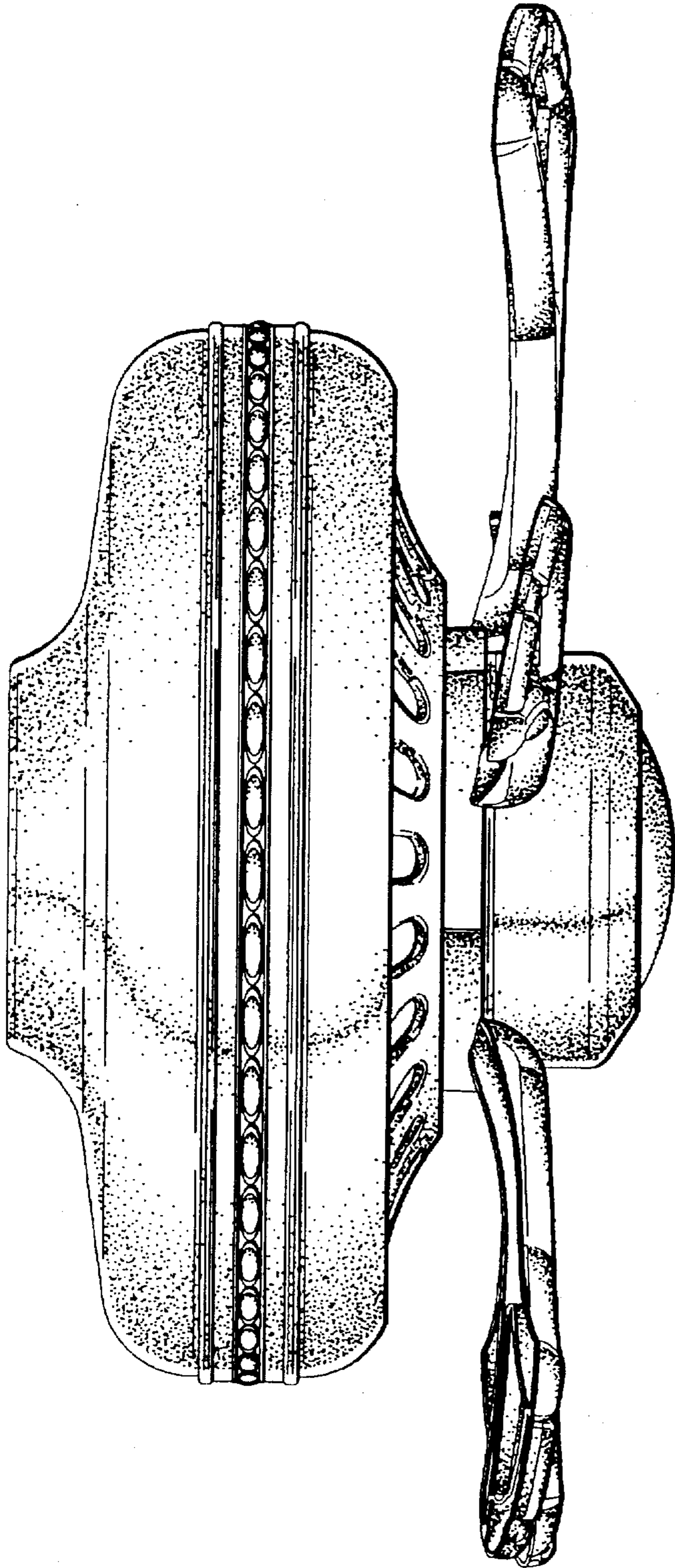
**FIG 10**



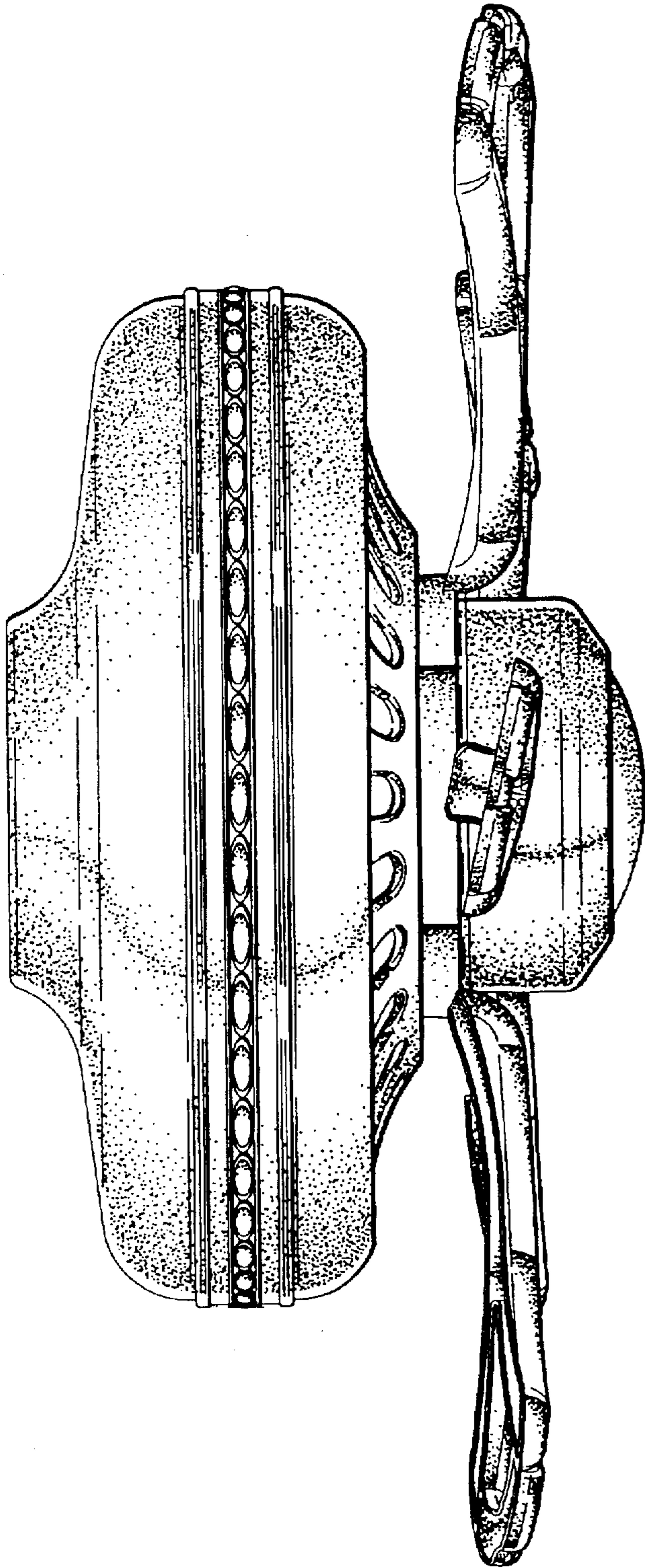




**FIG 11**



**FIG 12**



**FIG 13**



**FIG 14**

