



US00D408013S

United States Patent [19]

Zimmer et al.

[11] Patent Number: **Des. 408,013**

[45] Date of Patent: ****Apr. 13, 1999**

[54] CONNECTION MODULE FOR A PCB
(PRINTED CIRCUIT BOARD)

D. 359,026	6/1995	House et al.	D13/147
3,951,494	4/1976	Romine	439/82
4,917,614	4/1990	Kikuchi et al.	439/83
5,356,299	10/1994	Kunishi et al.	439/83

[75] Inventors: **Sabine Zimmer; Frank Mössner**, both of Berlin, Germany

[73] Assignee: **Krone Aktiengesellschaft**, Berlin-Zehlendorf, Germany

[**] Term: **14 Years**

[21] Appl. No.: **29/077,506**

[22] Filed: **Oct. 2, 1997**

[30] **Foreign Application Priority Data**

May 23, 1997 [DE] Germany M 97 04 897

[51] LOC (6) Cl. **13-03**

[52] U.S. Cl. **D13/147**

[58] Field of Search D13/144; 439/78, 439/81, 82, 83

[56] **References Cited**

U.S. PATENT DOCUMENTS

D. 194,602 2/1963 Lamont D13/147

Primary Examiner—Joel Sincavage
Attorney, Agent, or Firm—McGlew and Tuttle

[57] **CLAIM**

The ornamental design for a connection module for a PCB (printed circuit board), as shown and described.

DESCRIPTION

FIG. 1 is a front elevation view showing our new design; FIG. 2 is a top plan view thereof; FIG. 3 is a right side elevation view thereof; FIG. 4 is a rear elevation view thereof; FIG. 5 is a bottom plan view thereof; FIG. 6 is a left side elevational view thereof; and, FIG. 7 is a perspective view thereof.

1 Claim, 3 Drawing Sheets

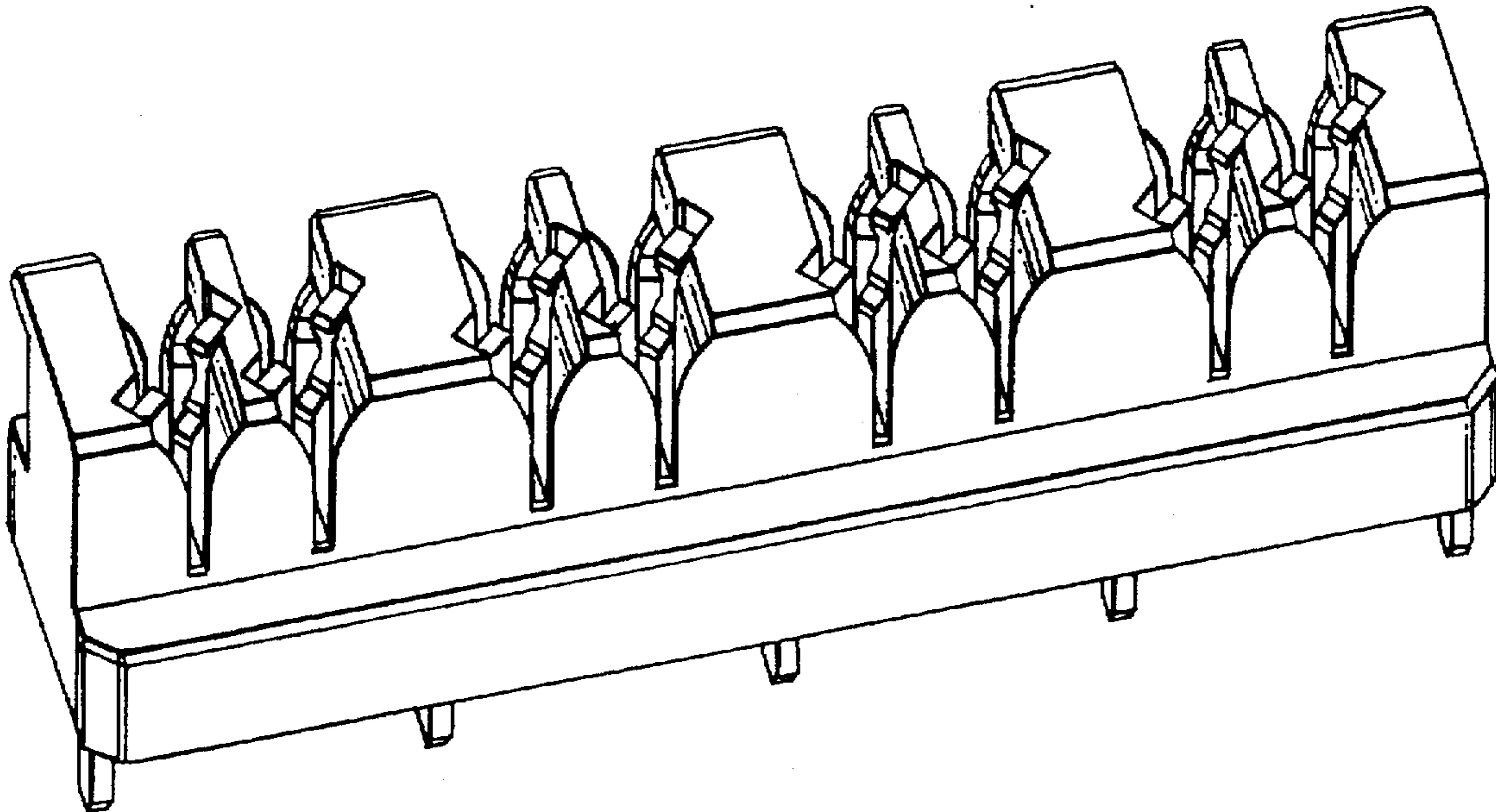

FIG.1

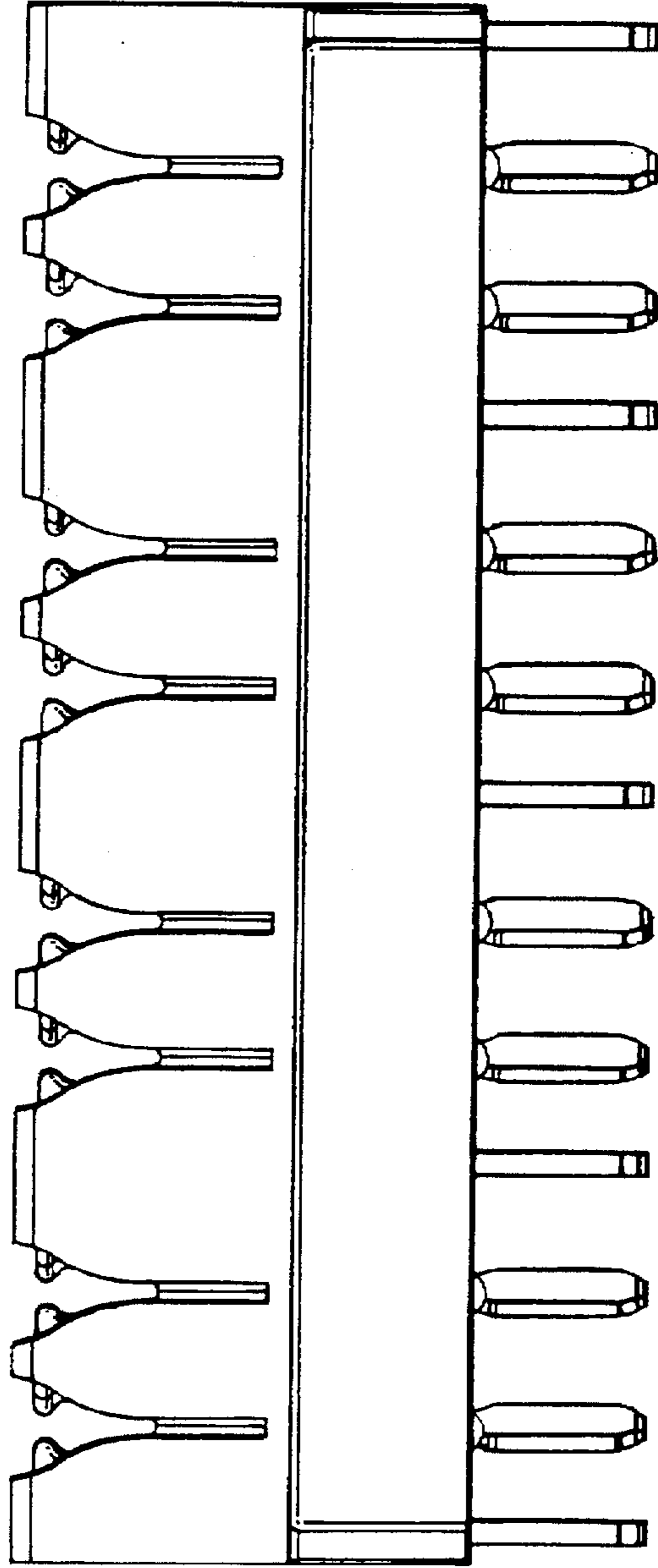

FIG.2

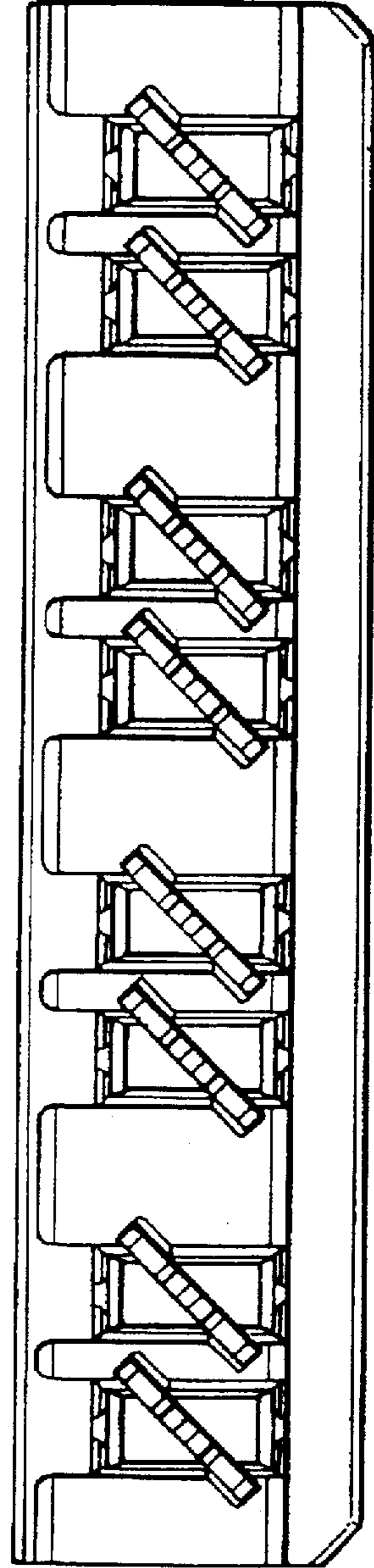

FIG.3

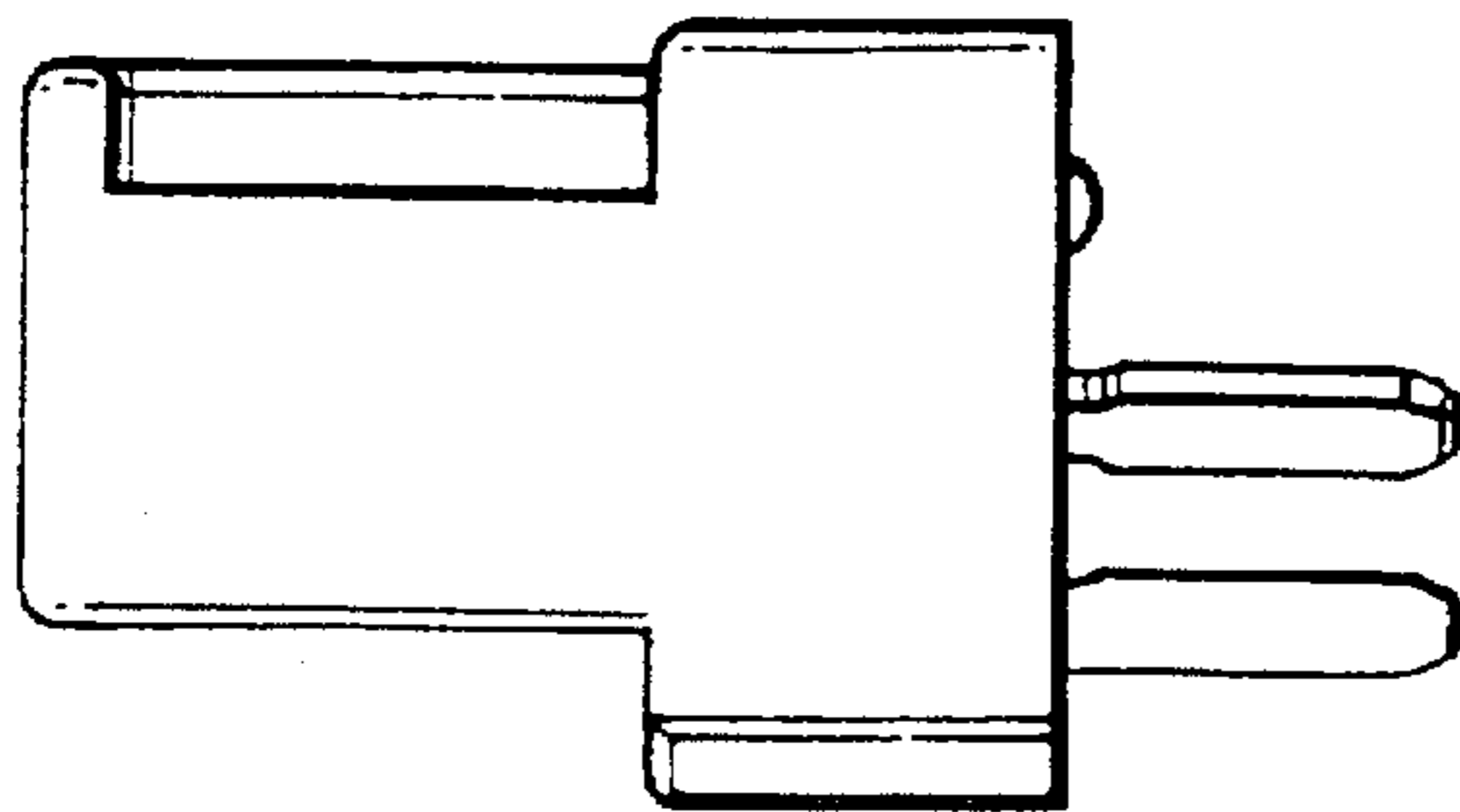

FIG. 4

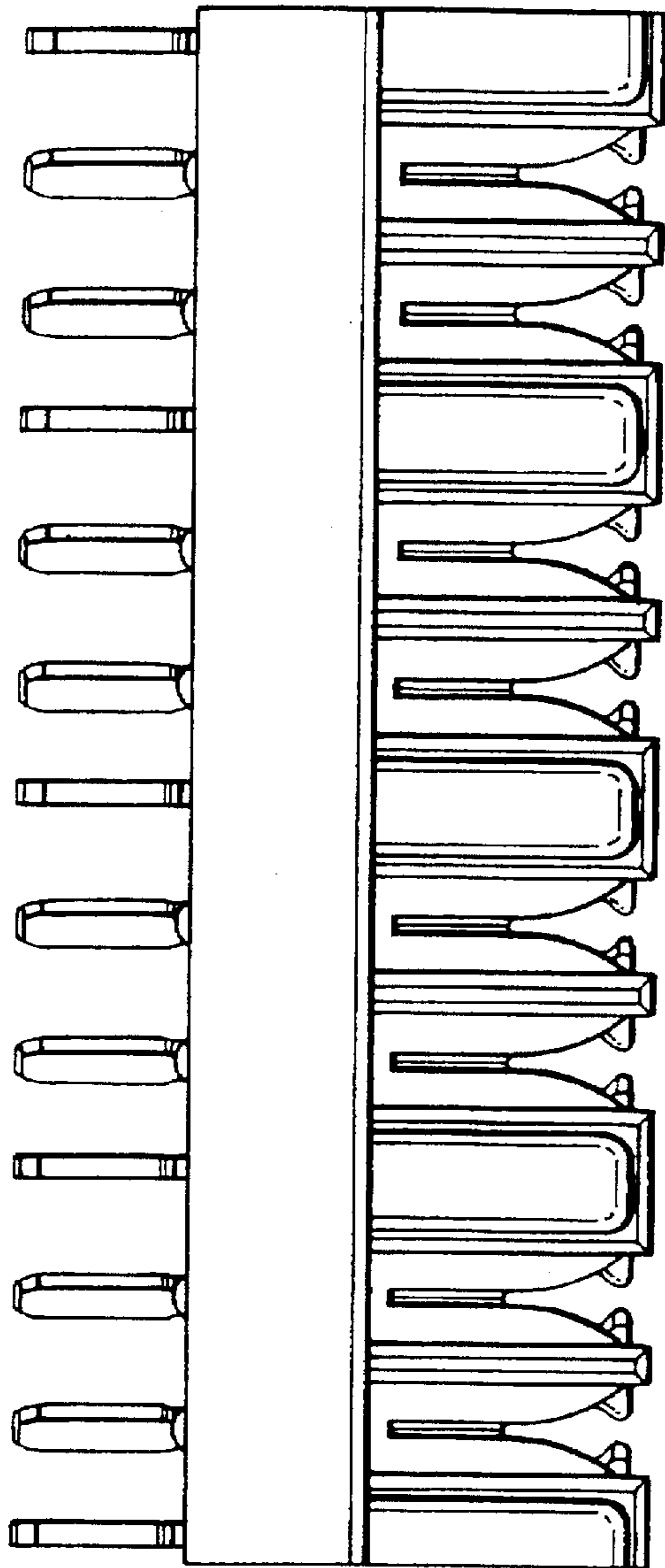

FIG. 6

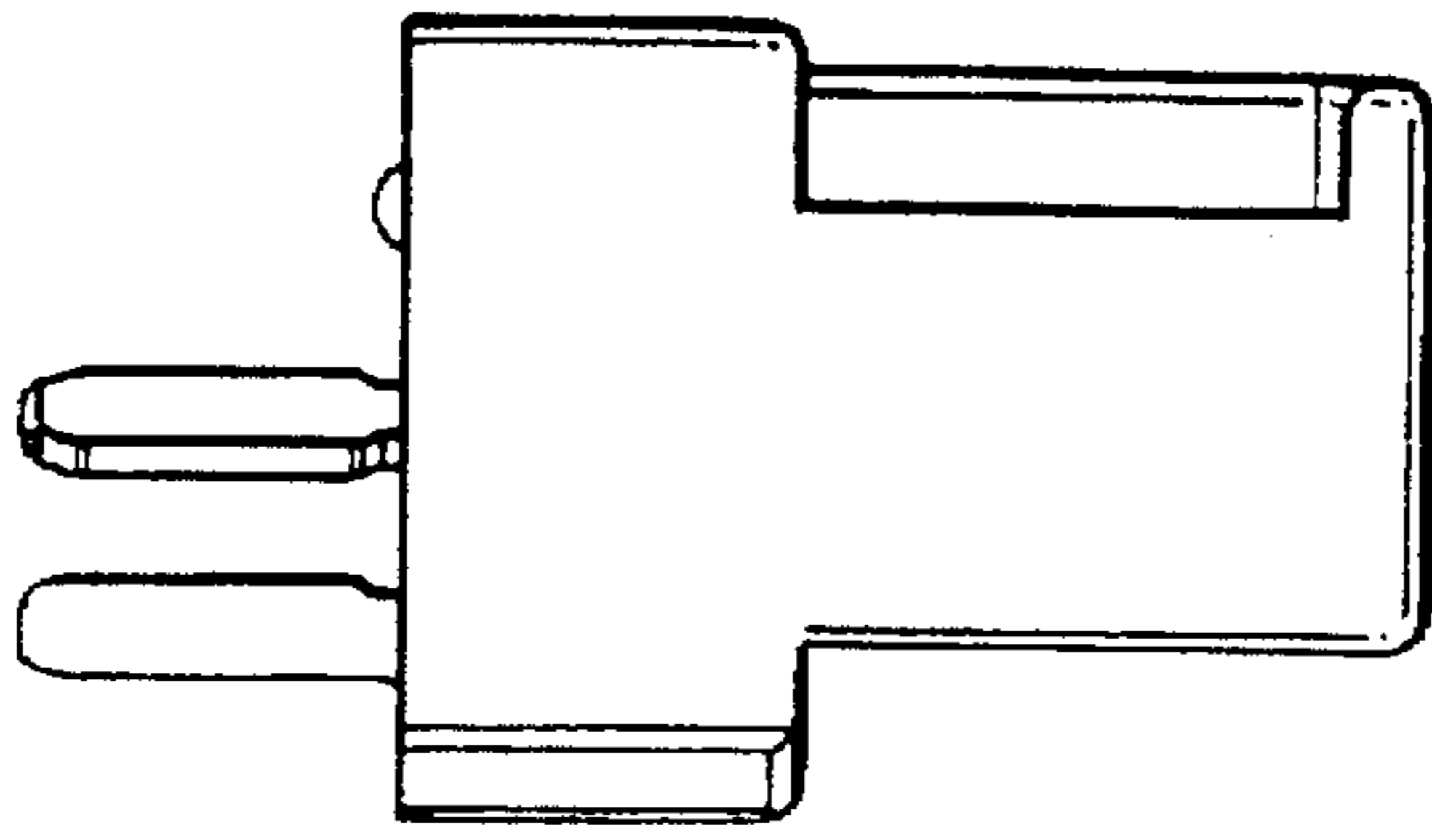

FIG. 5

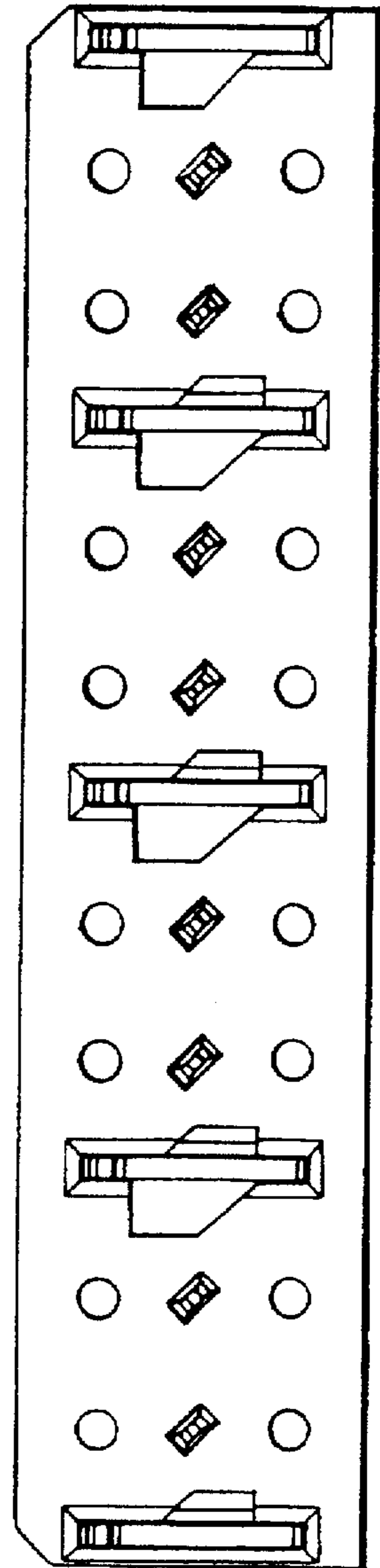

FIG. 7

