



US00D407987S

# United States Patent [19]

[11] Patent Number: Des. 407,987

Dittmore et al.

[45] Date of Patent: \*\*Apr. 13, 1999

## [54] SIGN HOLDER

Attorney, Agent, or Firm—Sand & Sebolt

[75] Inventors: **Karen S. Dittmore; James J. Dittmore**, both of Canton; **Robert J. Digiantonio; Terry D. Green**, both of North Canton, all of Ohio

## [57] CLAIM

The ornamental design for a sign holder, as shown and described.

[73] Assignee: **Nerako Enterprises, Inc.**, Canton, Ohio

## DESCRIPTION

[\*\*] Term: 14 Years

FIG. 1 is a perspective view of the first embodiment of a sign holder showing our new design;

[21] Appl. No.: 29/083,821

FIG. 2 is a rear perspective view of the sign holder;

[22] Filed: Feb. 19, 1998

FIG. 3 is a front elevational view of the sign holder of FIG. 1;

[51] LOC (6) Cl. .... 10-05

FIG. 4 is a top plan view of FIG. 3;

[52] U.S. Cl. .... D10/109; D20/17

FIG. 5 is a left side elevational view of FIG. 3, the right side being a mirror image thereof;

[58] Field of Search ..... D10/109, 114; 116/63 P, 63 R; D20/10, 17, 41, 43; 40/646, 584, 612, 588, 605, 606, 607, 608, 642.02, 618

FIG. 6 is a bottom plan view of FIG. 3;

FIG. 7 is a rear elevational view of FIG. 3;

## [56] References Cited

### U.S. PATENT DOCUMENTS

|            |         |                |       |         |
|------------|---------|----------------|-------|---------|
| D. 257,614 | 12/1980 | Branner et al. | ..... | D10/114 |
| D. 351,807 | 10/1994 | Smith et al.   | ..... | D10/109 |
| 1,559,605  | 11/1925 | Ginger         | ..... | 40/588  |
| 5,493,292  | 2/1996  | Fanslow et al. | ..... | 40/612  |
| 5,729,926  | 3/1998  | Cowgill et al. | ..... | 40/612  |

FIG. 8 is a perspective view of the second embodiment of a sign holder;

FIG. 9 is a rear perspective view of the sign holder of FIG. 8;

FIG. 10 is a front elevational view of the sign holder of FIG. 8; and,

FIG. 11 is a rear elevational view of the sign holder of FIG. 10.

The second embodiment differs from the first only by the ribbed surfaces along the top two corners of the claimed design. The broken lines are shown for illustrative purposes only and form no part of the claimed design.

Primary Examiner—Susan J. Lucas  
Assistant Examiner—Jennifer Rivard

1 Claim, 9 Drawing Sheets

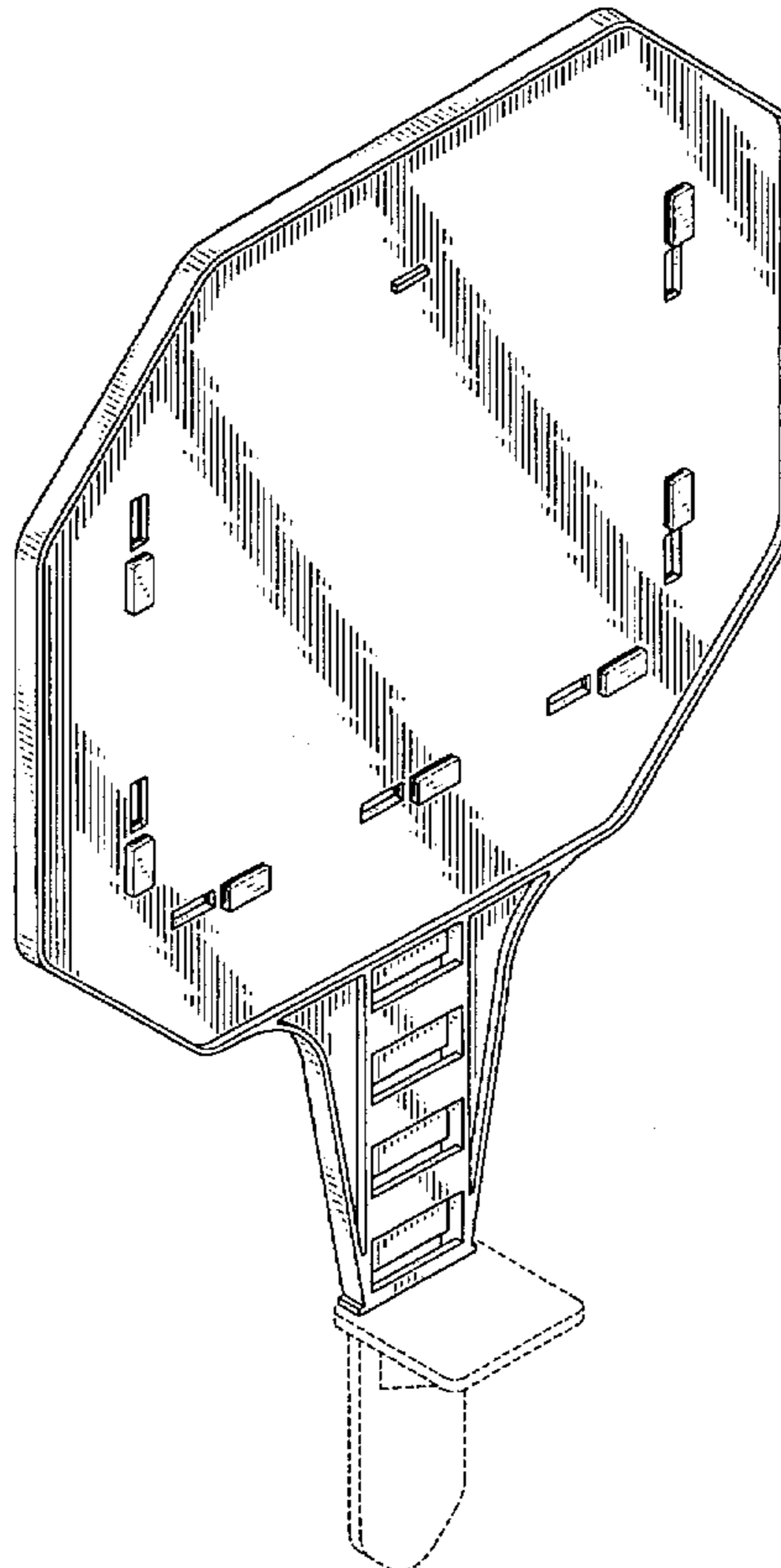

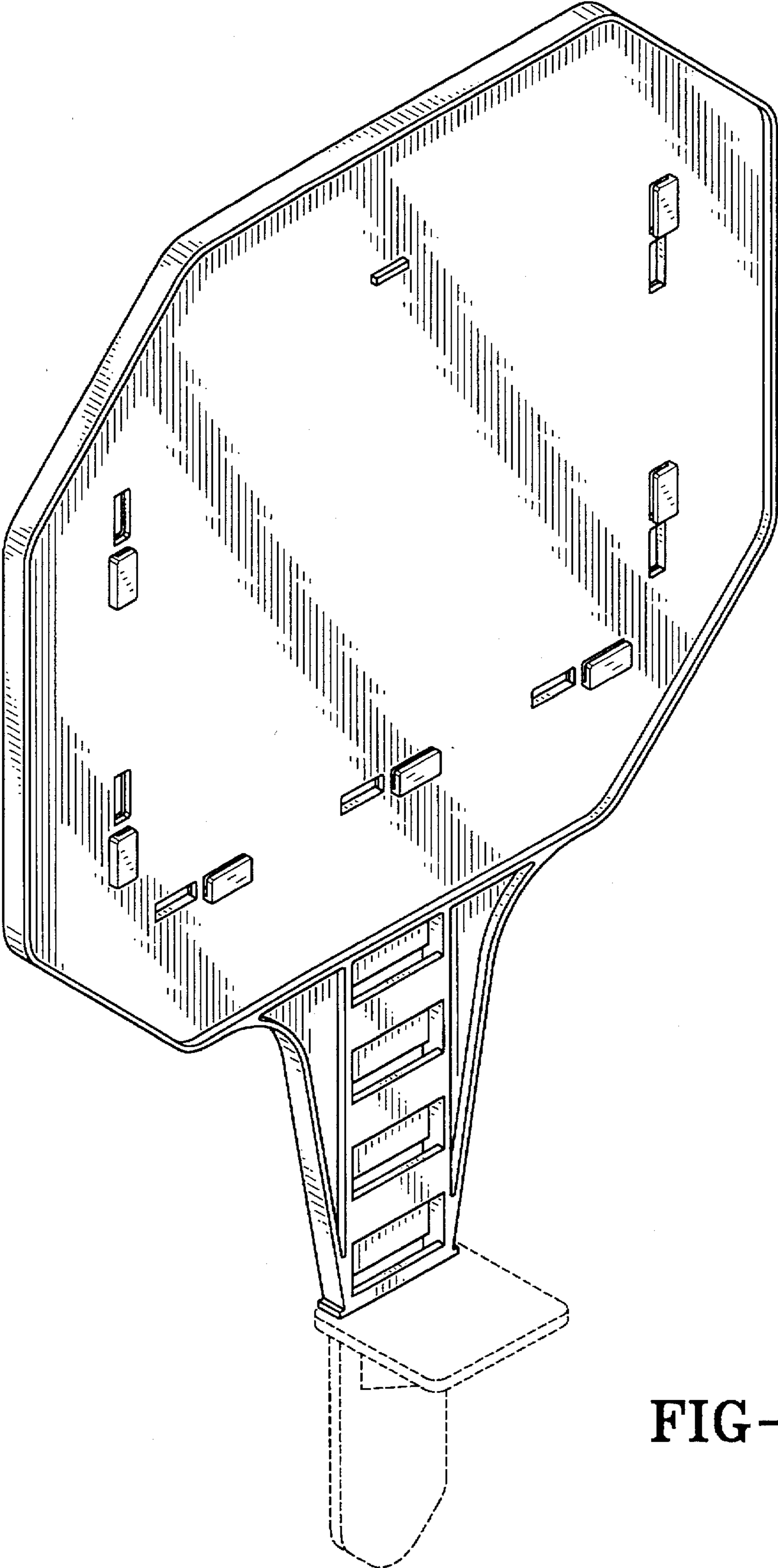

FIG-1

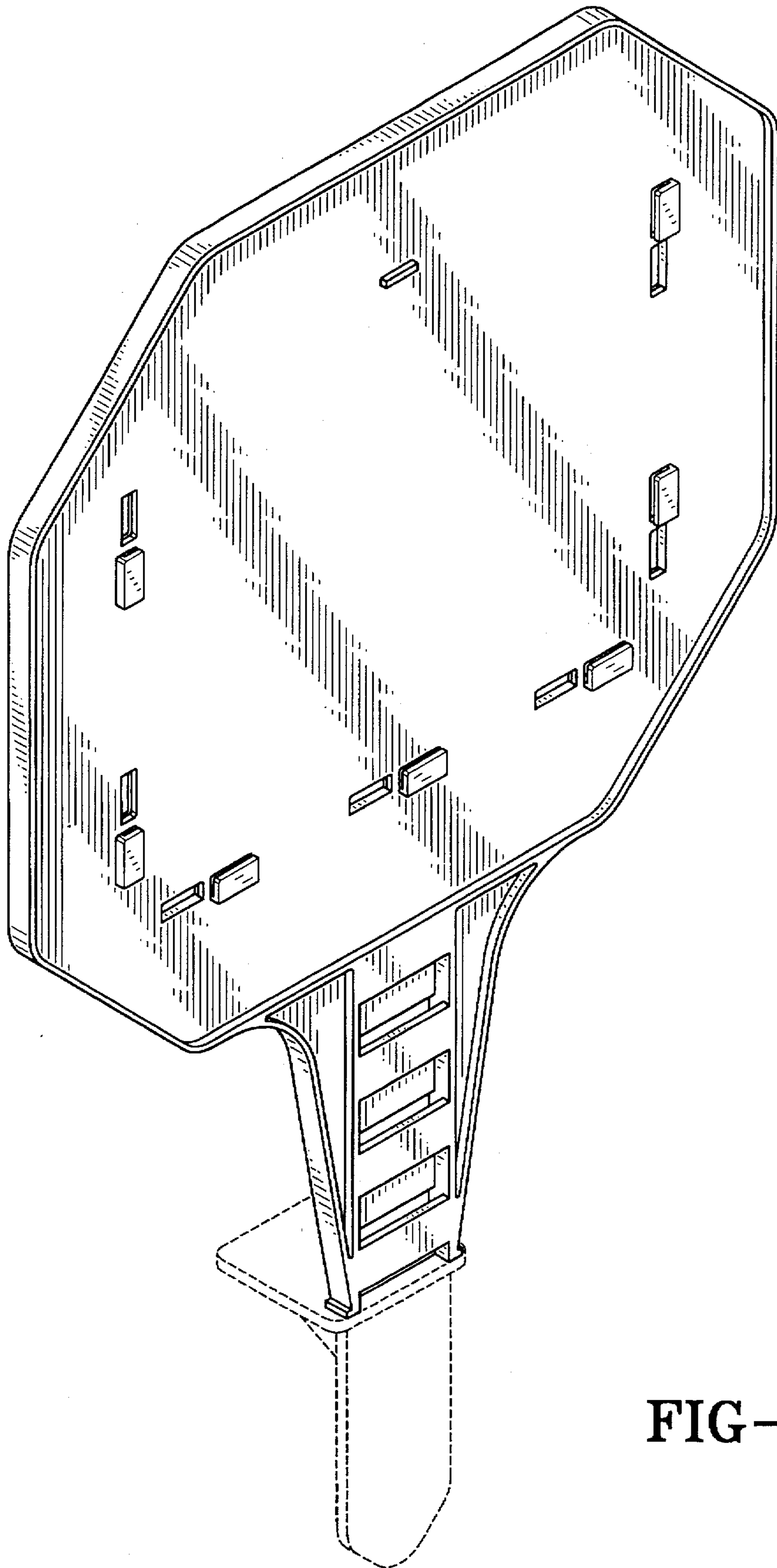
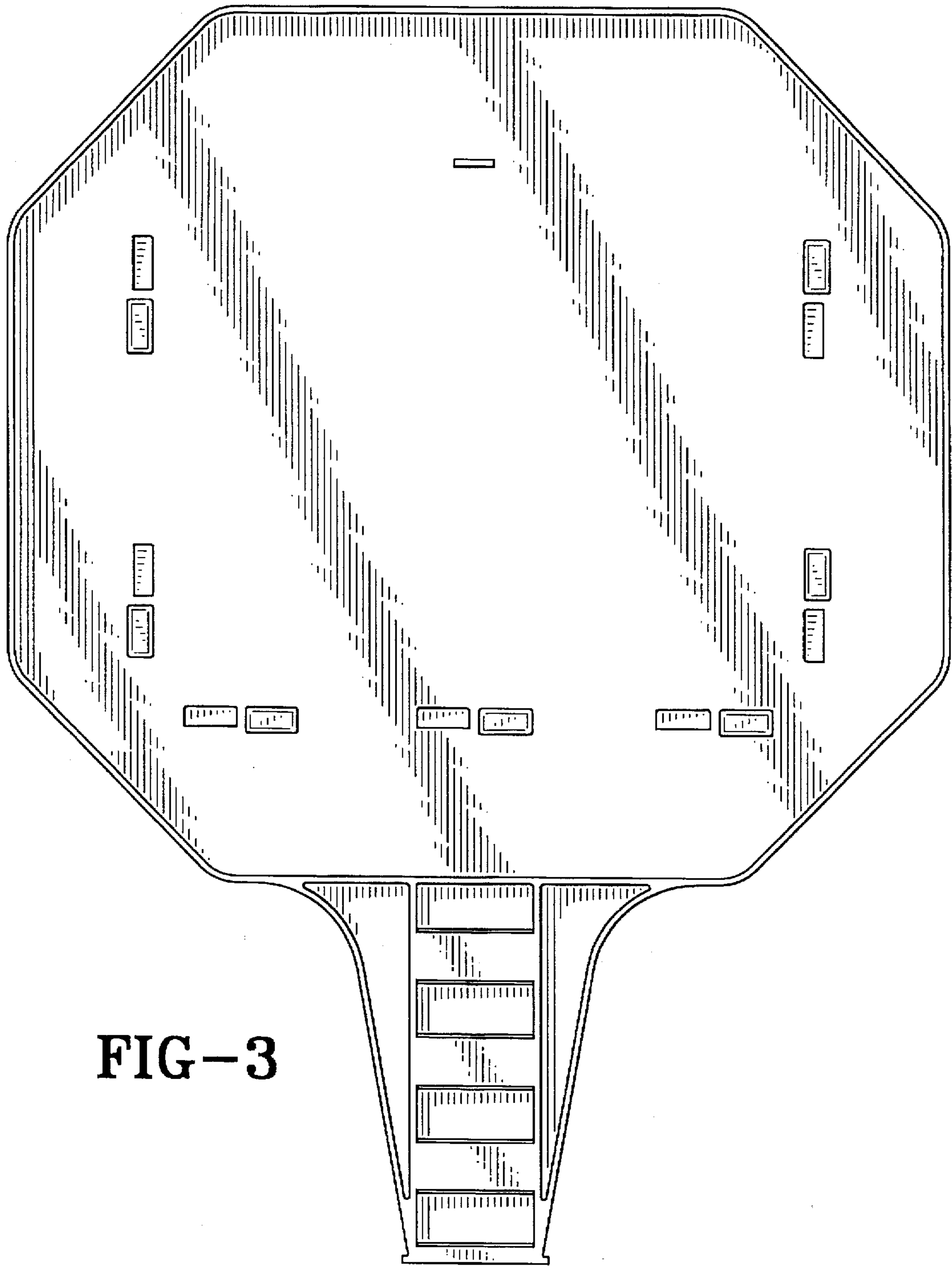
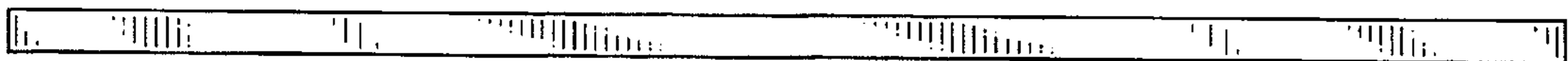

FIG-2



**FIG-3**



**FIG-4**



FIG-5

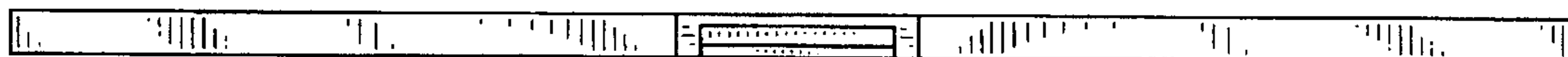

FIG-6

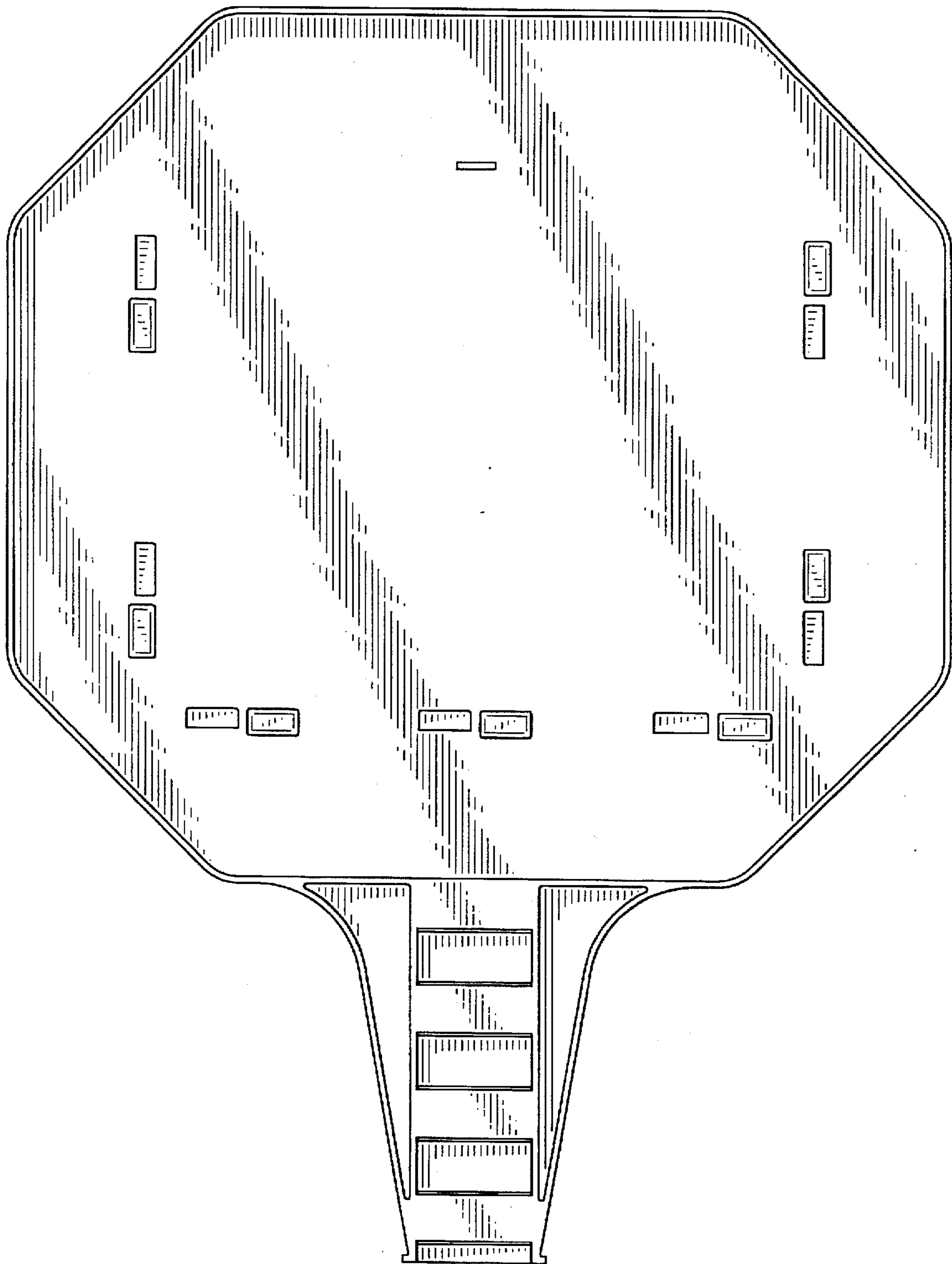

FIG-7

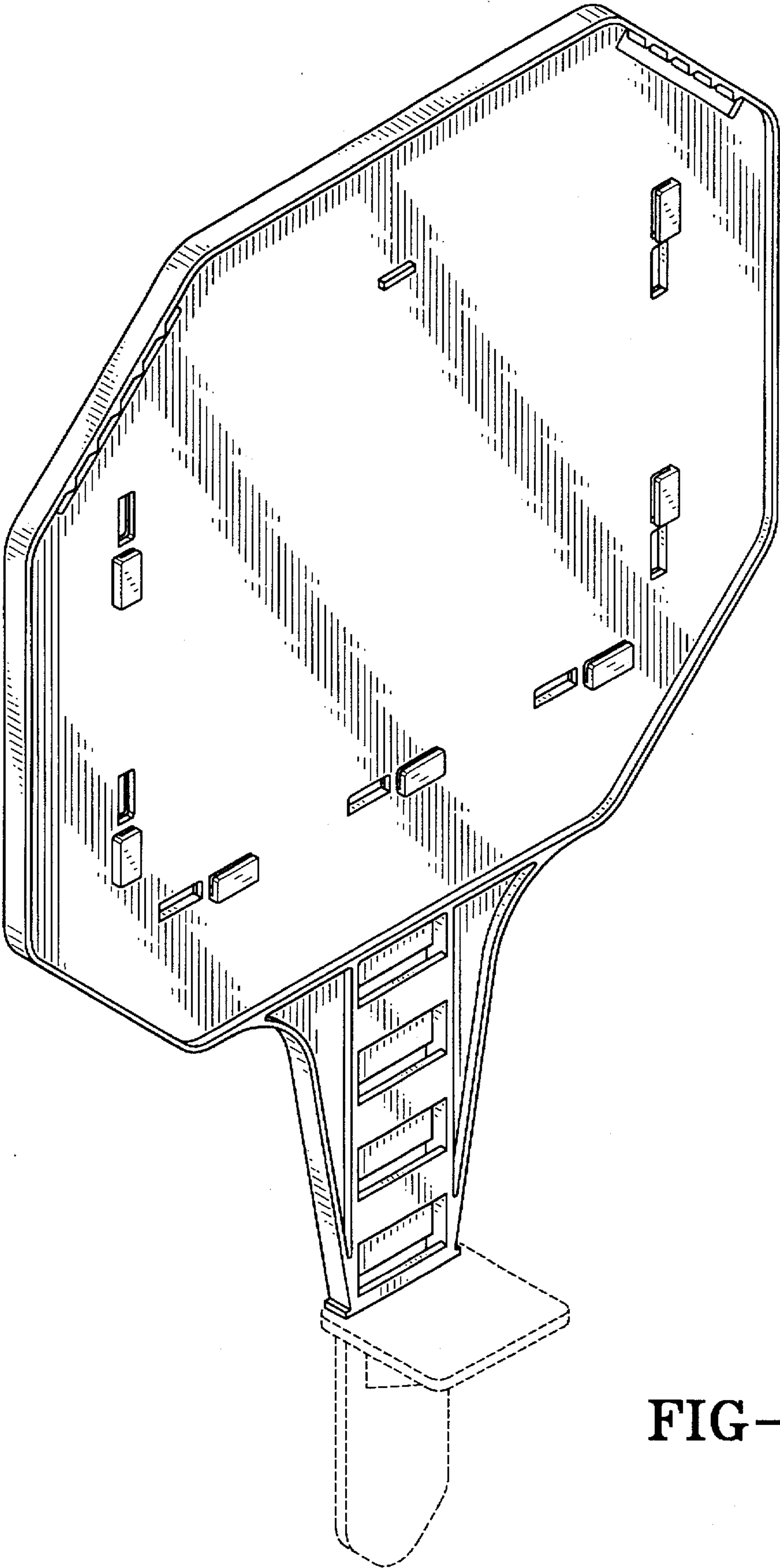

FIG-8

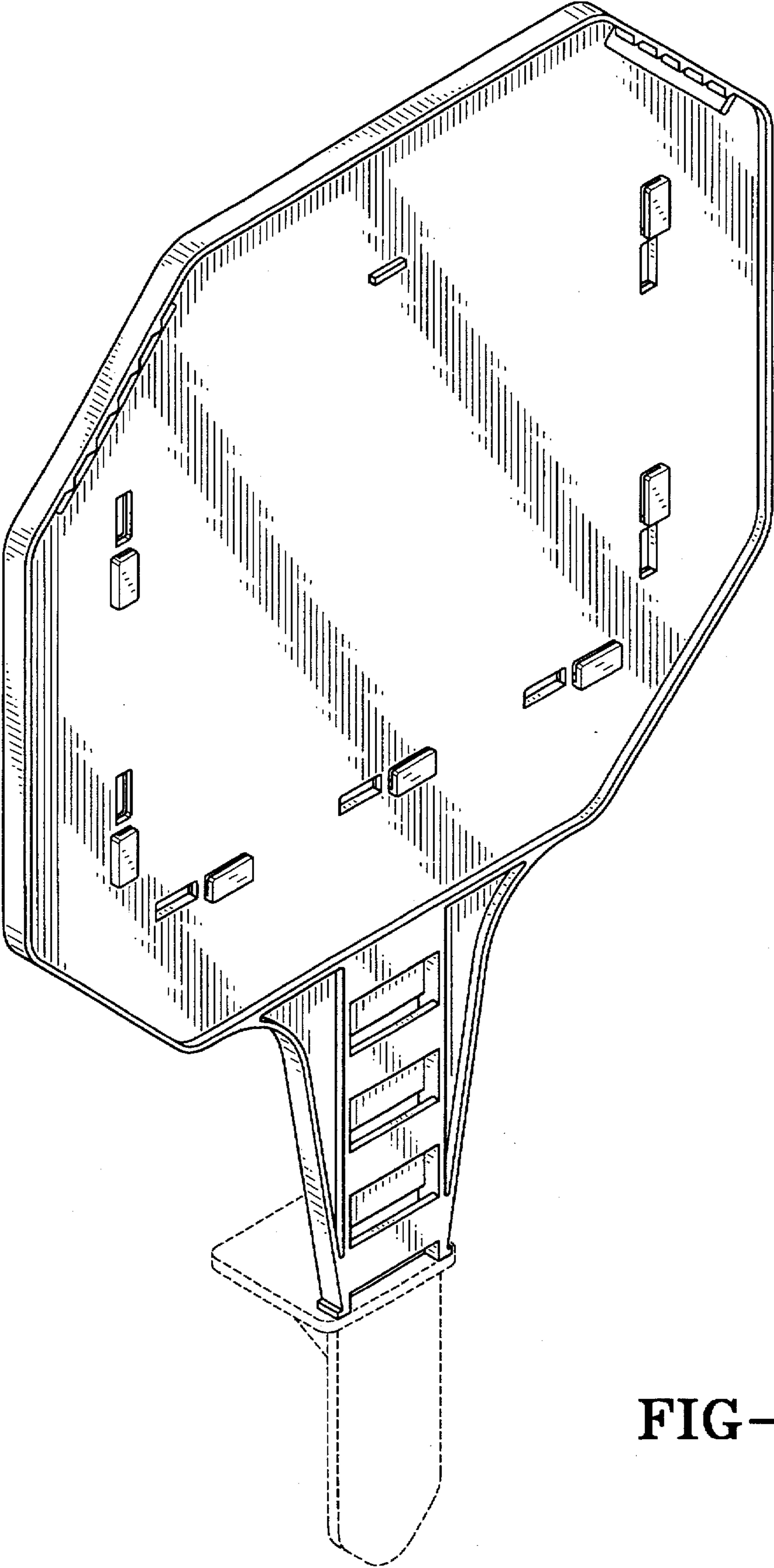

FIG-9



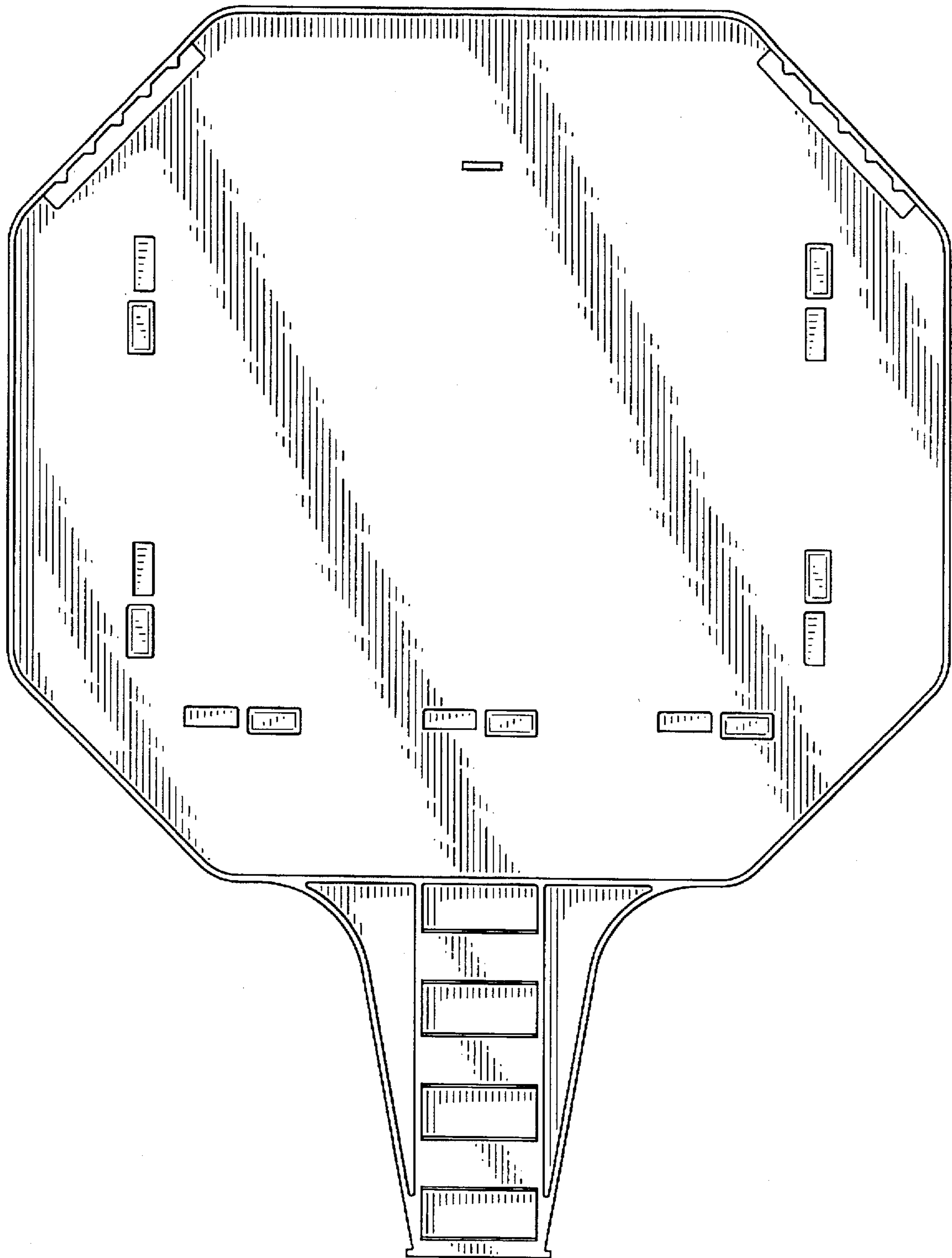

FIG-10

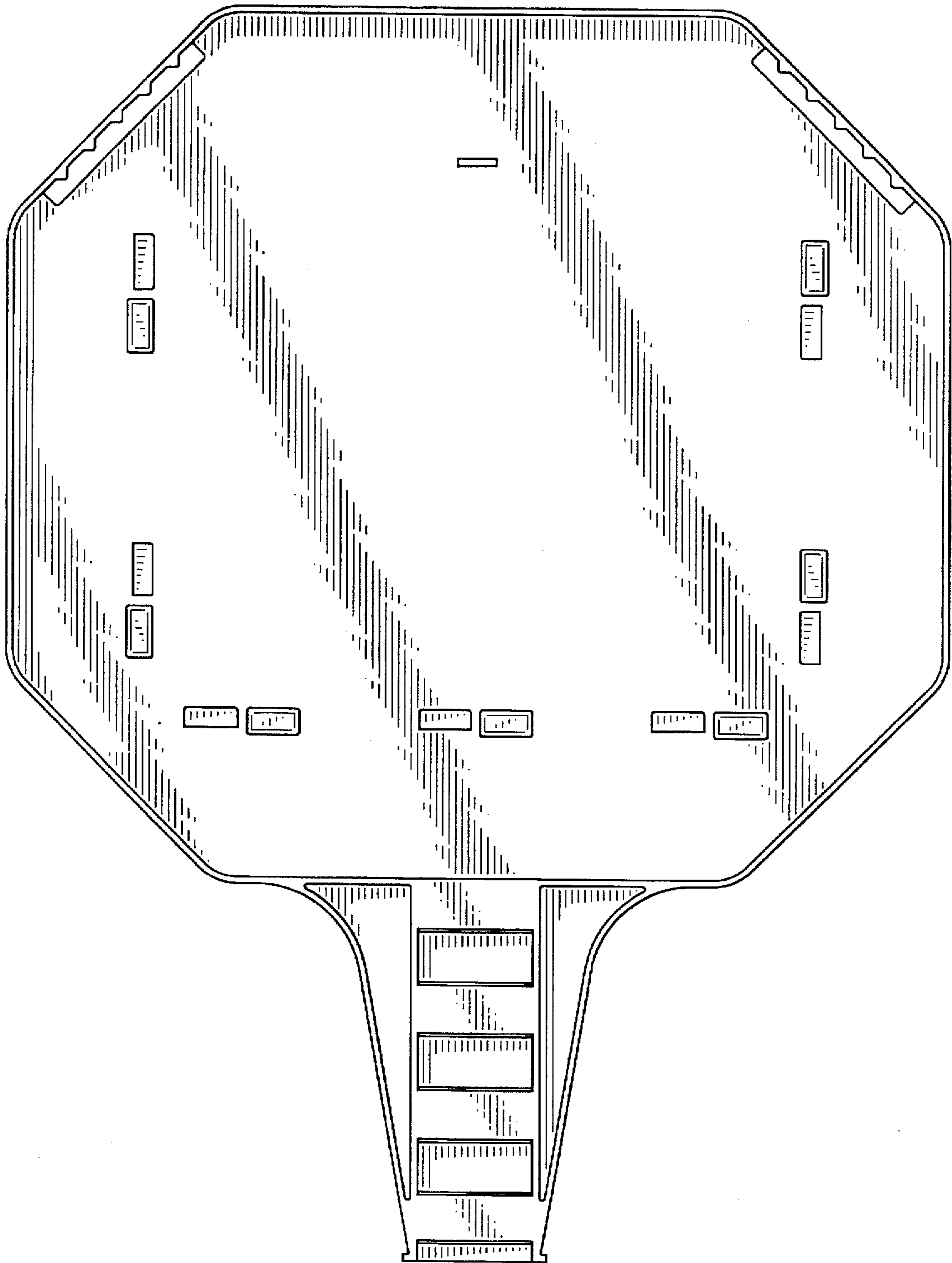

FIG-11