



US00D407947S

**United States Patent** [19]  
**Barth**

[11] **Patent Number: Des. 407,947**

[45] **Date of Patent: \*\*Apr. 13, 1999**

[54] **GLASS**

[75] **Inventor: Leo M. Barth, Los Angeles, Calif.**

[73] **Assignee: AAA Glass Corporation, Los Angeles, Calif.**

[\*\*] **Term: 14 Years**

[21] **Appl. No.: 29/078,797**

[22] **Filed: Aug. 5, 1997**

[51] **LOC (6) Cl. .... 07-01**

[52] **U.S. Cl. .... D7/522; D7/521; D7/524**

[58] **Field of Search .... D7/509, 514, 518, D7/521, 522, 524, 537; 206/517, 519; 25/227**

[56] **References Cited**

**U.S. PATENT DOCUMENTS**

D. 43,570	2/1913	Heinzelman	.....	D7/518
D. 44,661	9/1913	Hunter	.....	D7/524
D. 67,903	7/1925	Schmidt	.....	D7/524
D. 87,872	10/1932	Cummins	.....	D7/524
D. 97,755	12/1935	Bedford et al.	.....	D7/521
D. 108,354	2/1938	Buma	.....	D7/521

D. 109,487	5/1938	Kostellow	.....	D7/521
D. 112,517	12/1938	Cunningham	.....	D7/521
D. 217,001	3/1970	Stone	.....	D7/524
D. 248,715	8/1978	Gobleck, Jr.	.....	D7/521
D. 278,964	5/1985	Dair et al.	.....	D7/521
D. 318,981	8/1991	Calby	.....	D7/537
D. 370,155	5/1996	Harrison et al.	.....	D7/524

*Primary Examiner*—M. N. Pandozzi  
*Attorney, Agent, or Firm*—Oppenheimer Wolff & Donnelly LLP

[57] **CLAIM**

The ornamental design for a glass, as shown and described.

**DESCRIPTION**

FIG. 1 is a perspective view of a glass showing my new design;  
FIG. 2 is a front elevational view;  
FIG. 3 is a side elevational view;  
FIG. 4 is a side elevational view;  
FIG. 5 is a rear elevational view;  
FIG. 6 is a top view; and,  
FIG. 7 is a bottom view.

**1 Claim, 6 Drawing Sheets**

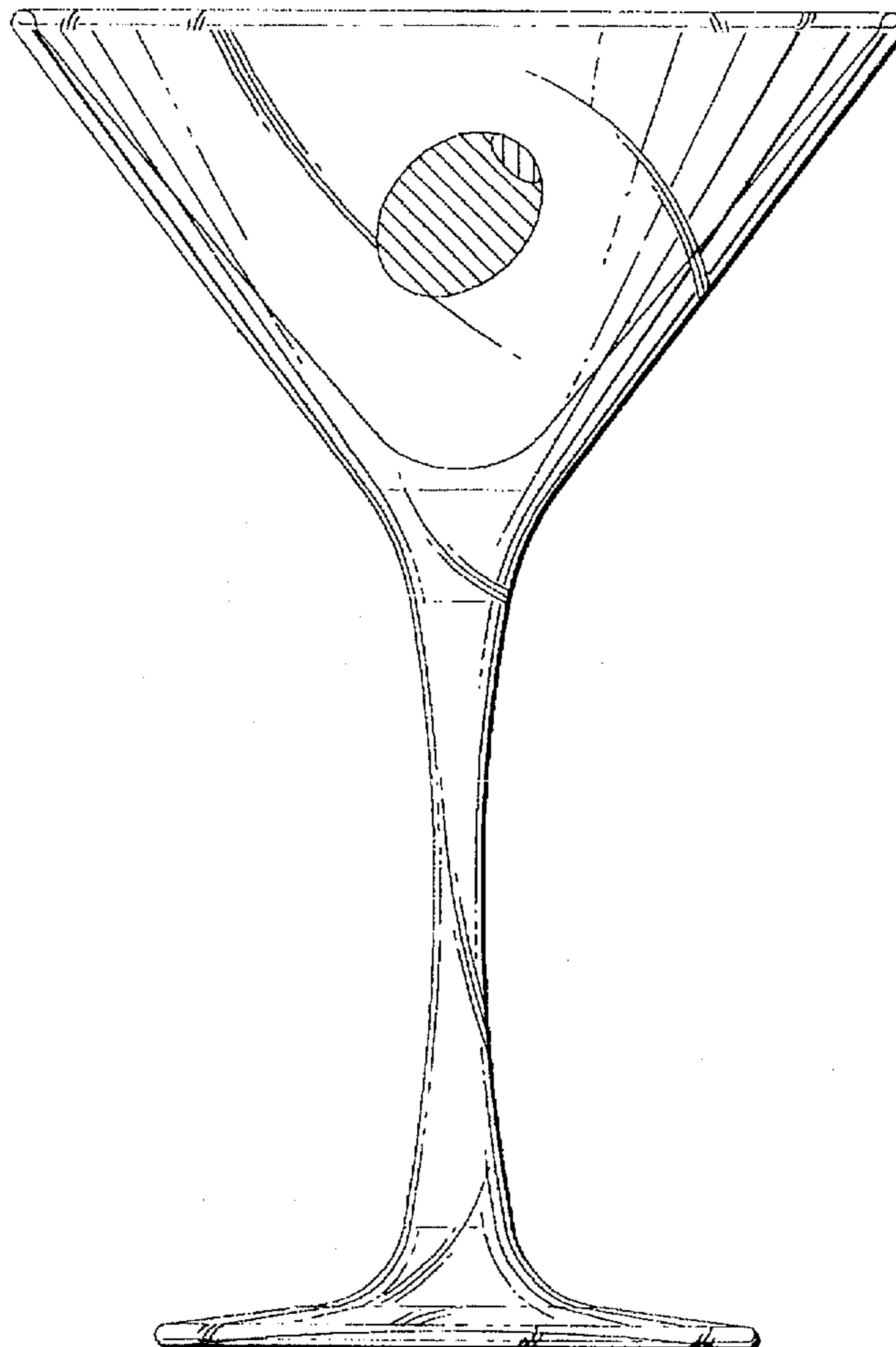

FIG. 1

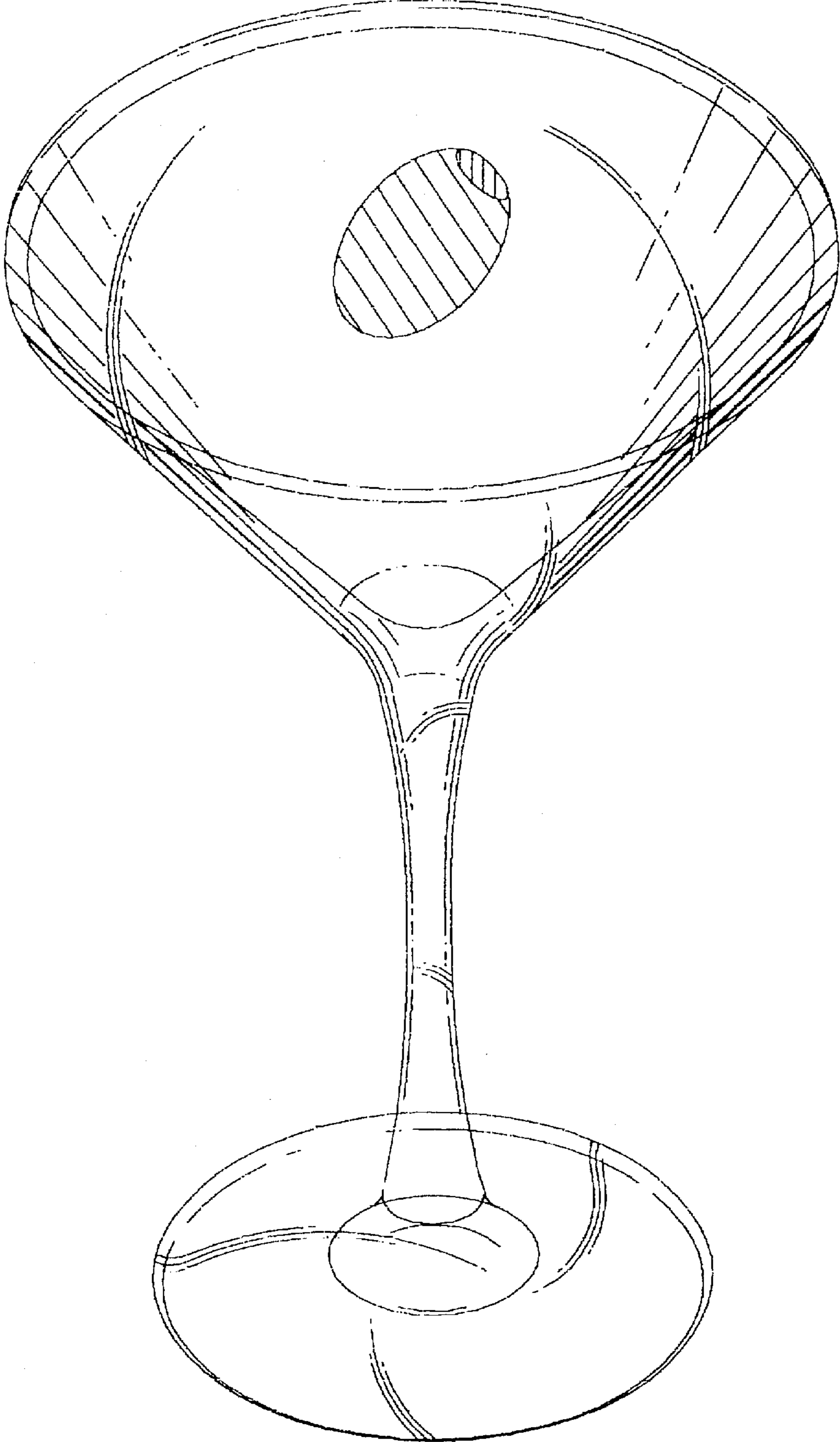

FIG. 2

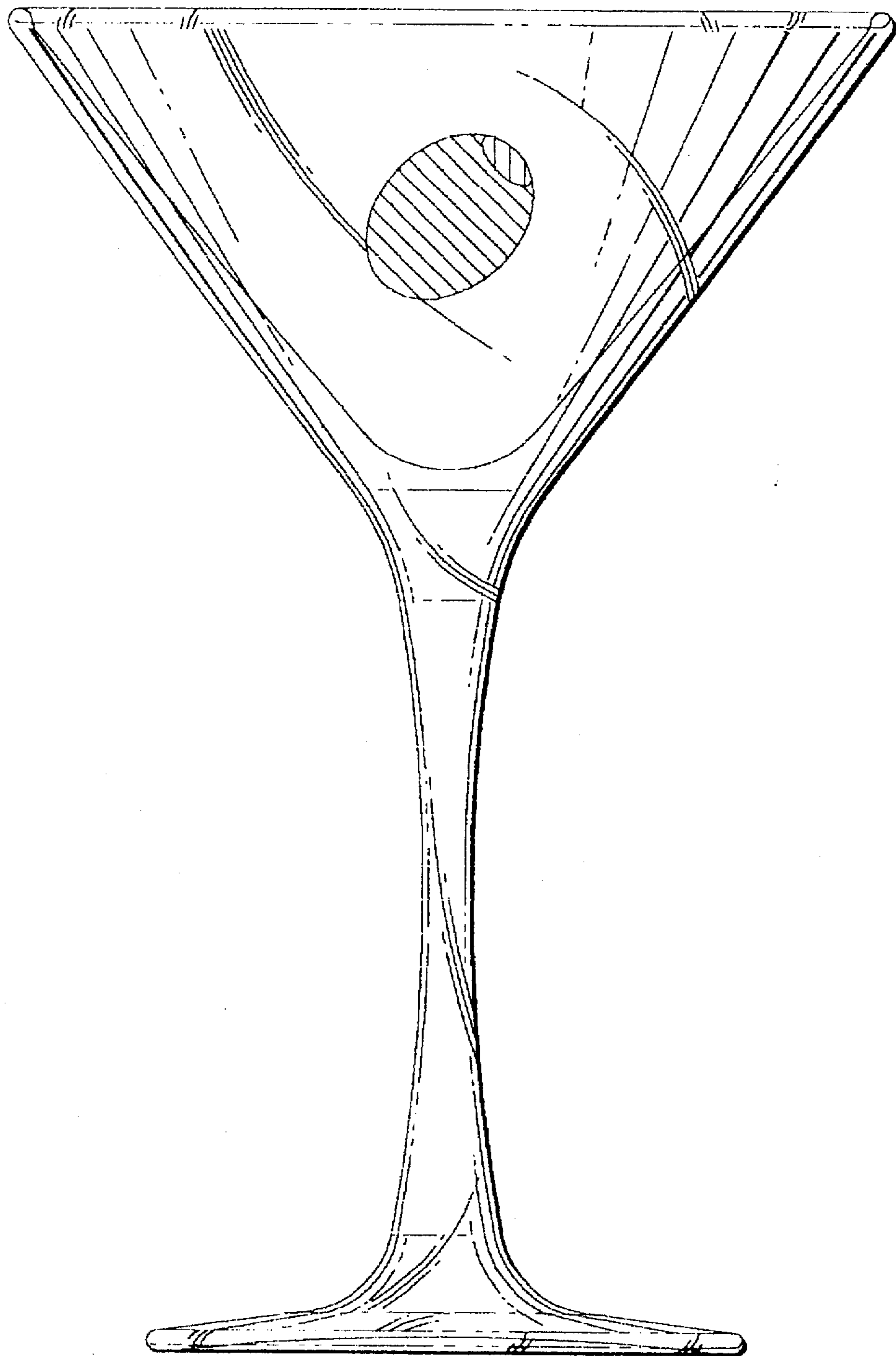

FIG. 3

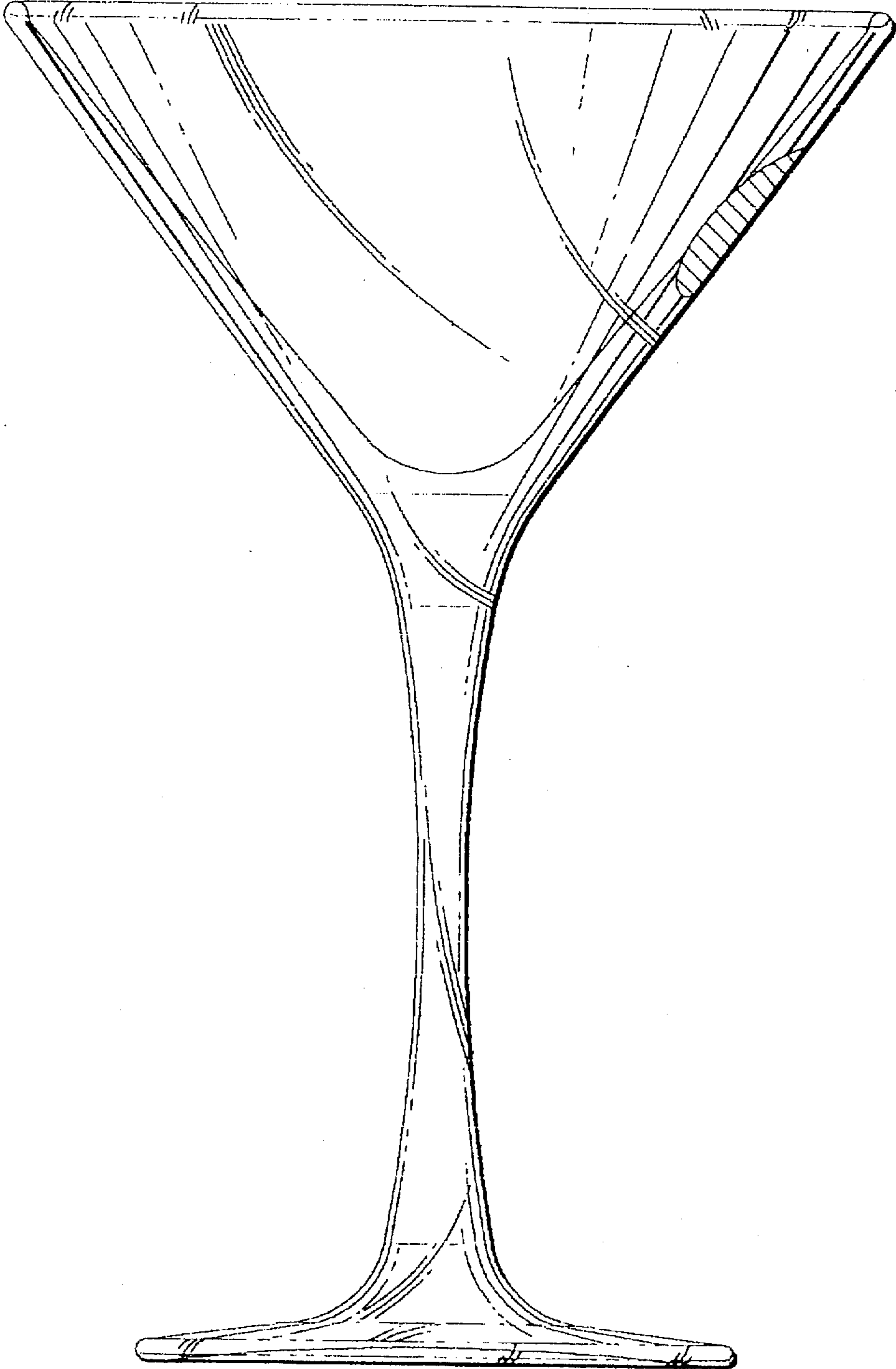

FIG. 4

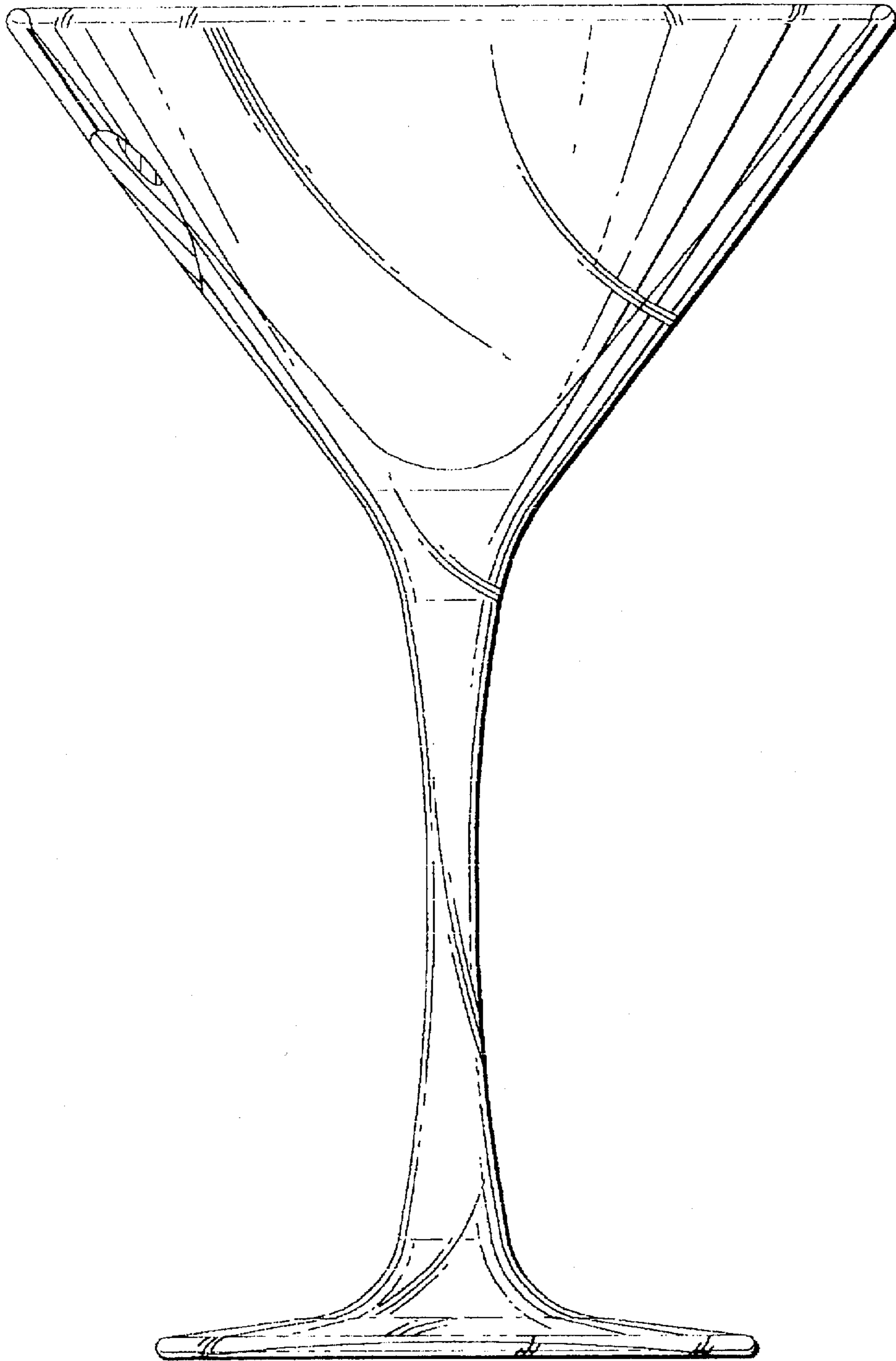



FIG. 5

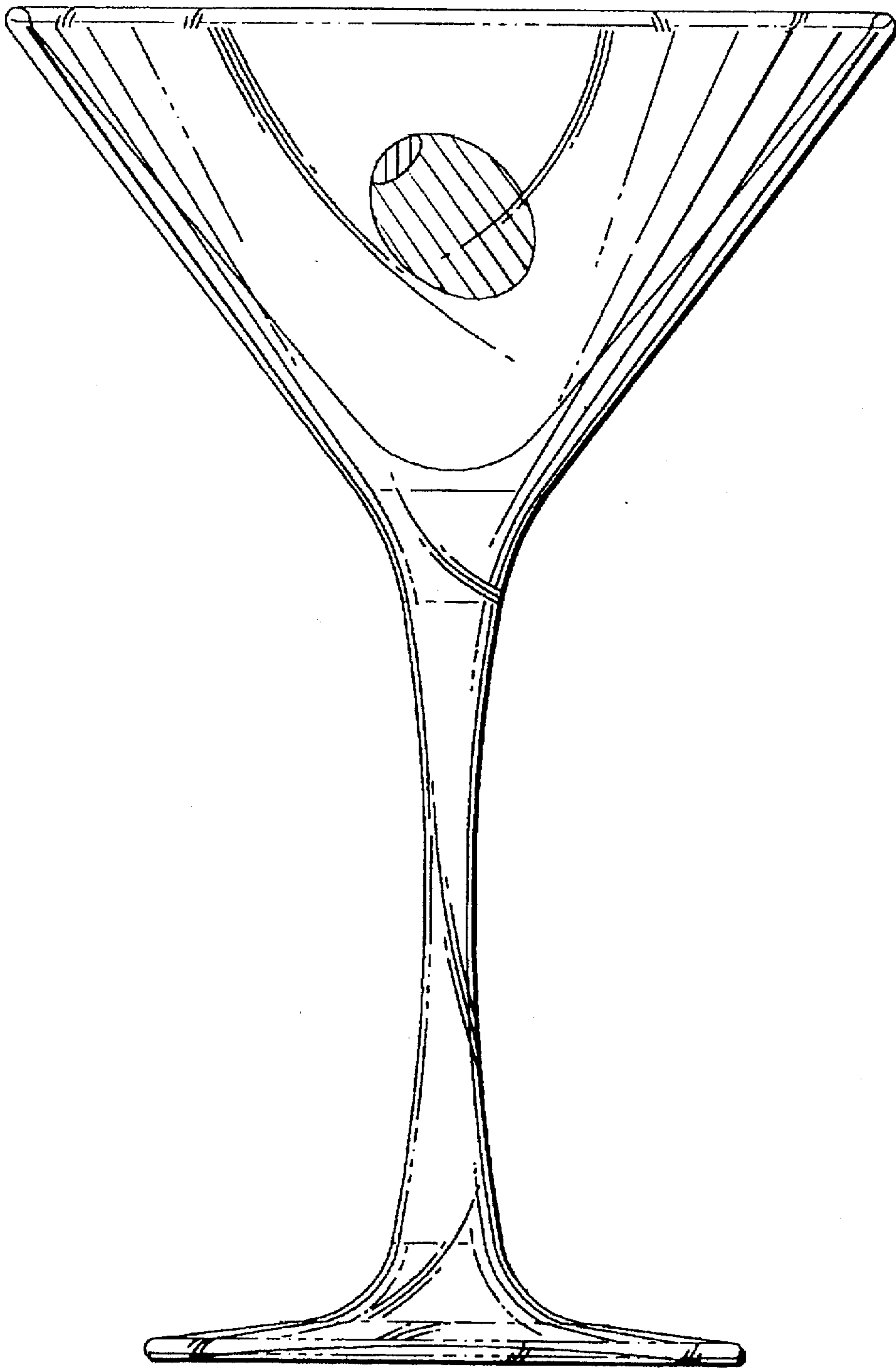

FIG. 6

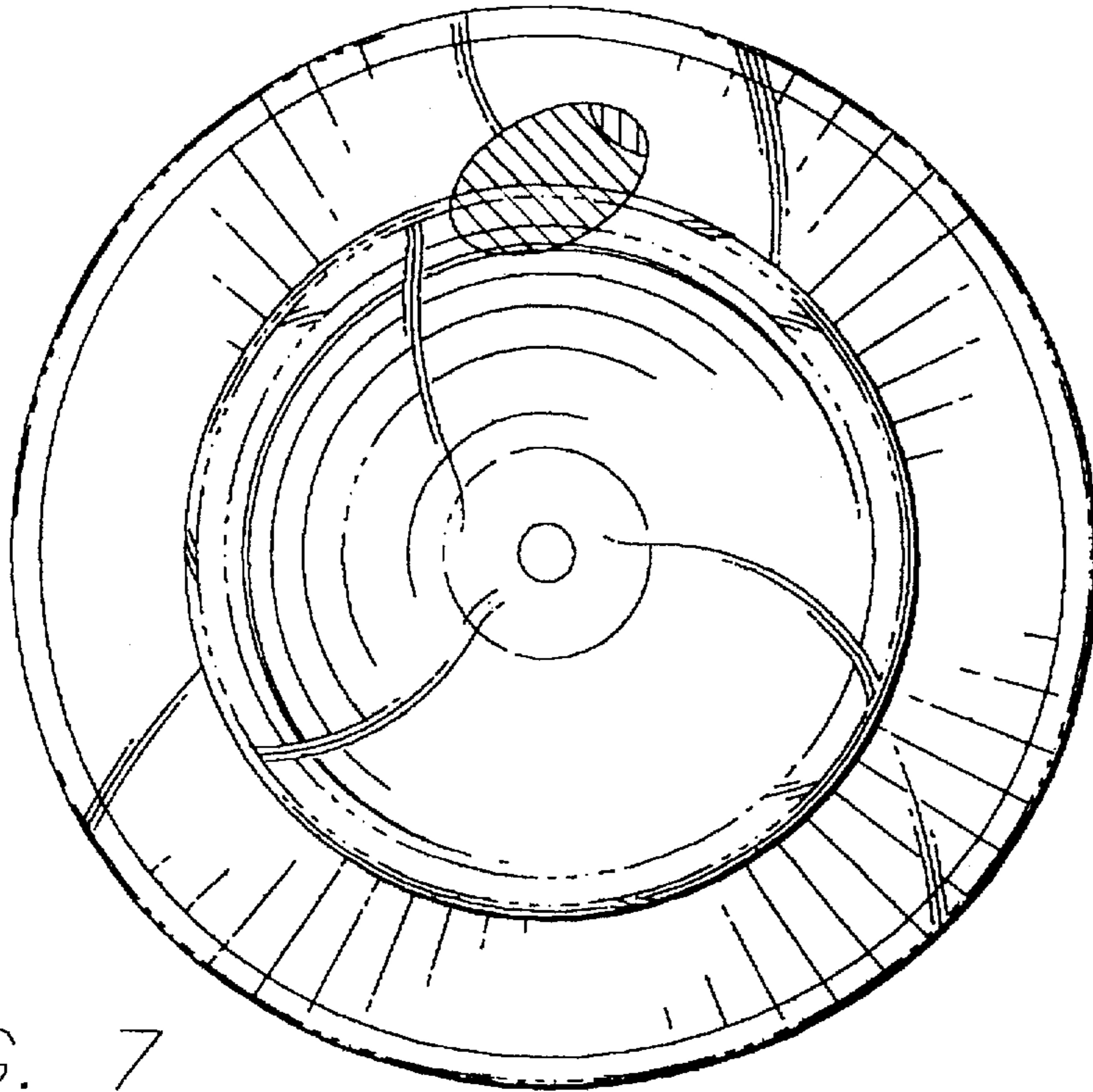
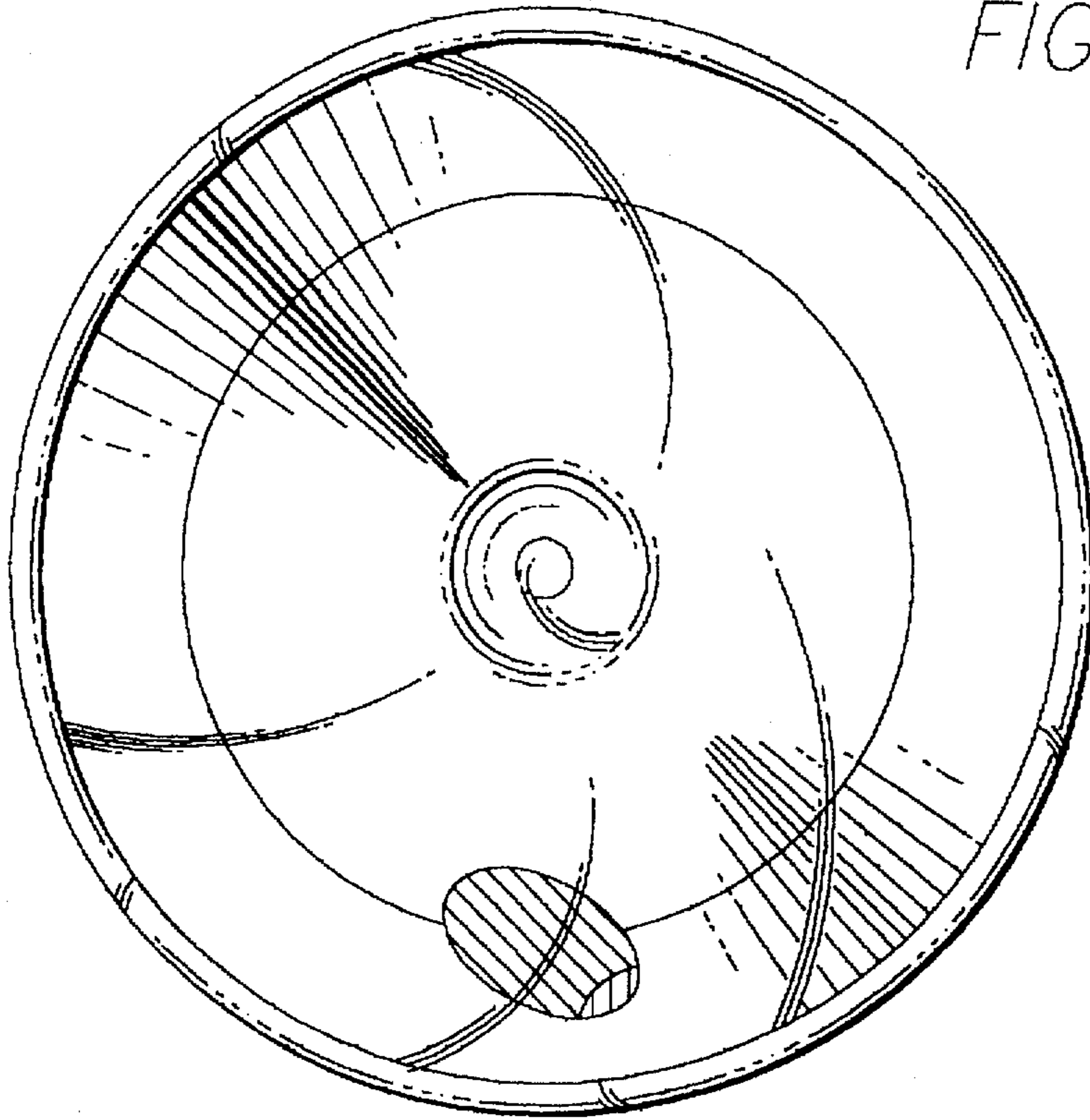

FIG. 7