



US00D407879S

United States Patent [19]
Gunawan

[11] **Patent Number: Des. 407,879**

[45] **Date of Patent: **Apr. 6, 1999**

[54] **DISH DRAINER WITH COVER**

5,158,184 10/1992 Craft et al. 211/41

[76] Inventor: **Wisnu Gunawan**, 8-20 College Point Blvd., Flushing, N.Y. 11356

Primary Examiner—Alan P. Douglas
Assistant Examiner—Robin V. Taylor
Attorney, Agent, or Firm—Goldstein & Canino

[**] Term: **14 Years**

[57] **CLAIM**

[21] Appl. No.: **84,665**

The ornamental design for a dish drainer with cover, as shown and described.

[22] Filed: **Mar. 6, 1998**

[51] **LOC (6) Cl.** **07-05**

[52] **U.S. Cl.** **D32/55**

[58] **Field of Search** D32/55, 56; 220/572, 220/487; 211/41.3, 85.25; 4/654, 656; 150/165

DESCRIPTION

FIG. 1 is a diagrammatic perspective view of the dish drainer with cover;
FIG. 2 is a top plan view of the dish drainer with cover;
FIG. 3 is a bottom plan view thereof;
FIG. 4 left side elevational view thereof;
FIG. 5 is a right side elevational view thereof;
FIG. 6 is a front elevational view thereof; and,
FIG. 7 is a rear elevational view thereof.

[56] **References Cited**

U.S. PATENT DOCUMENTS

43,088	6/1864	Britain .	
D. 265,262	6/1982	Taylor	D32/55
410,818	9/1889	Wilson .	
2,186,965	1/1940	Castles	220/571

1 Claim, 4 Drawing Sheets

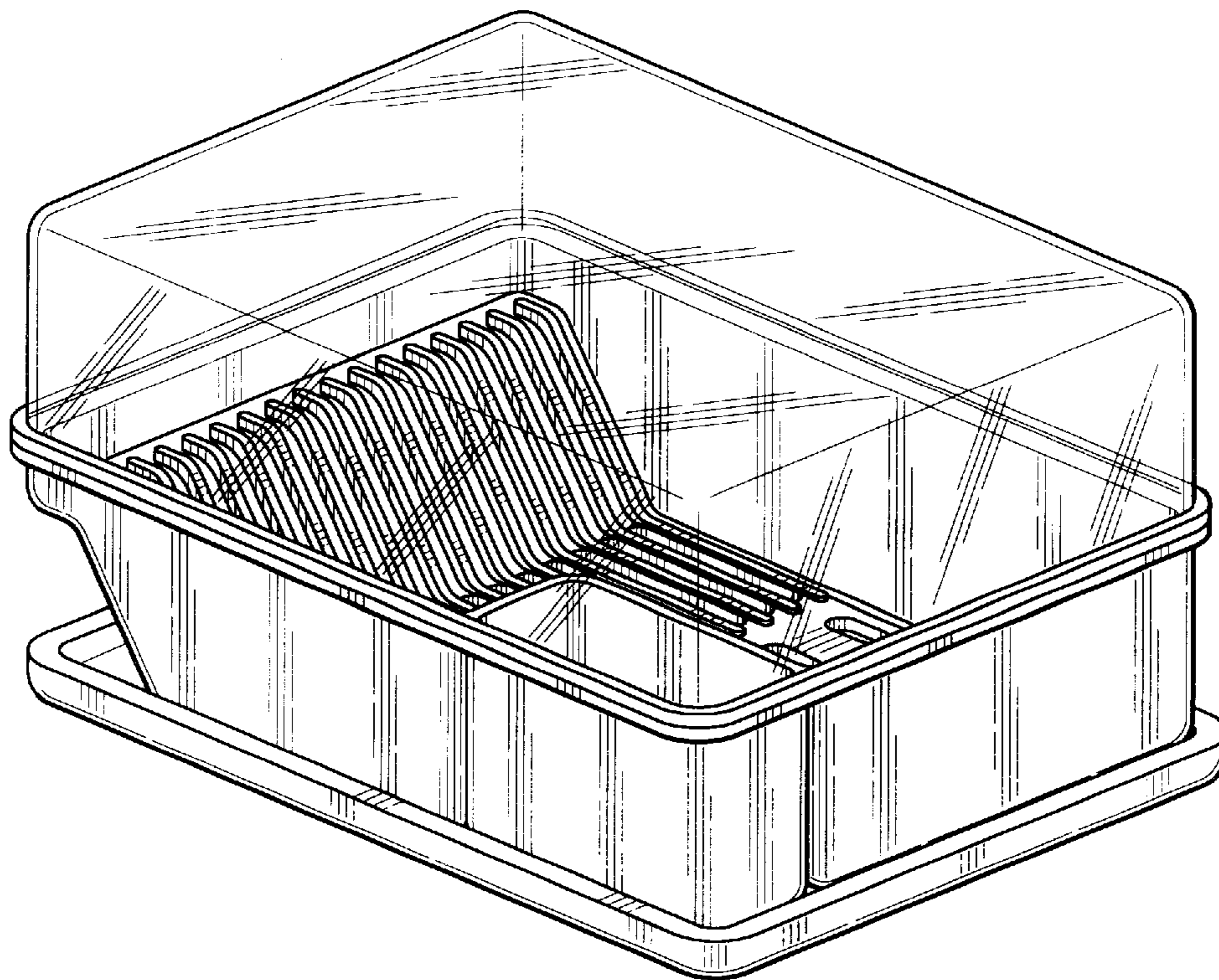

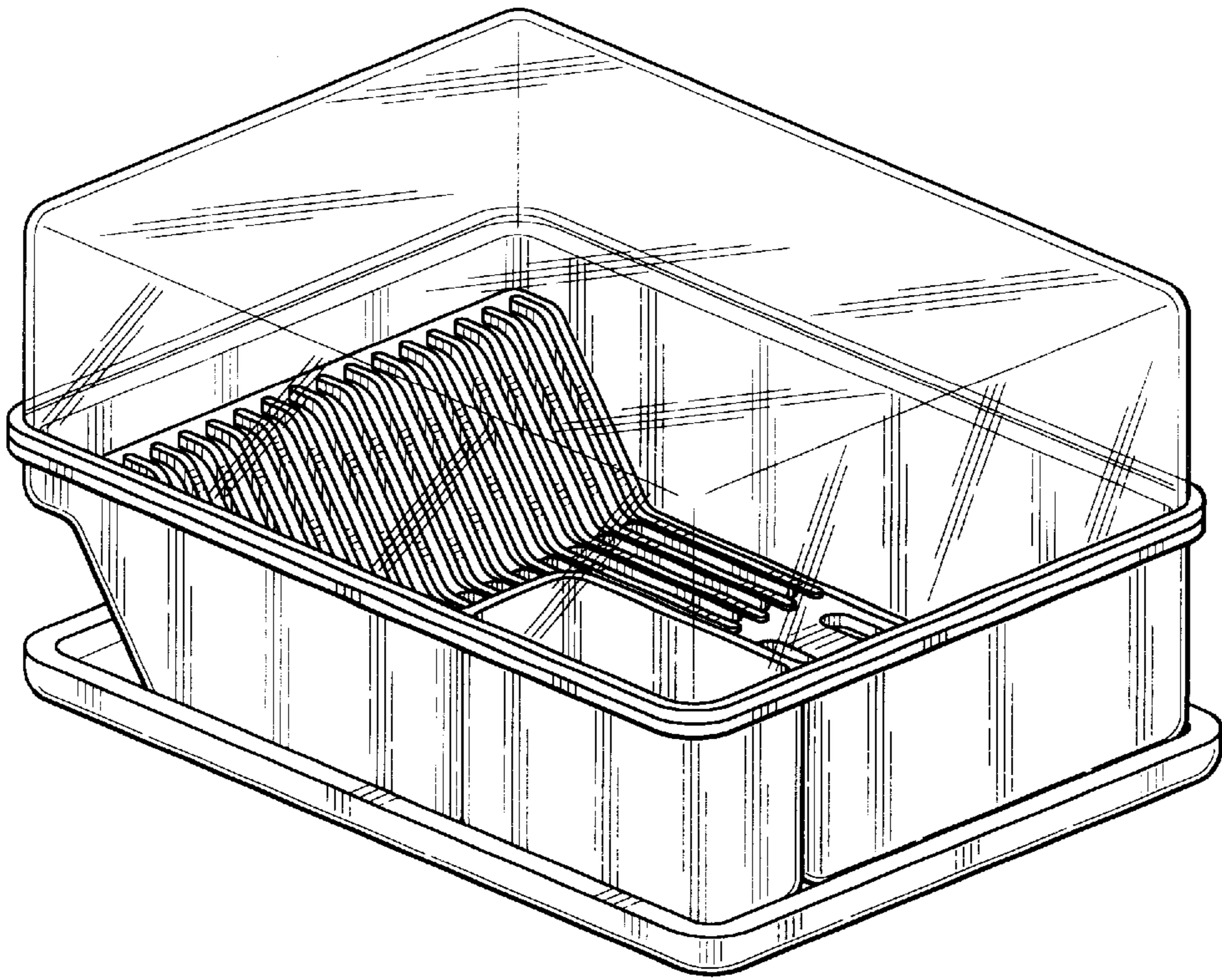

Fig. 1

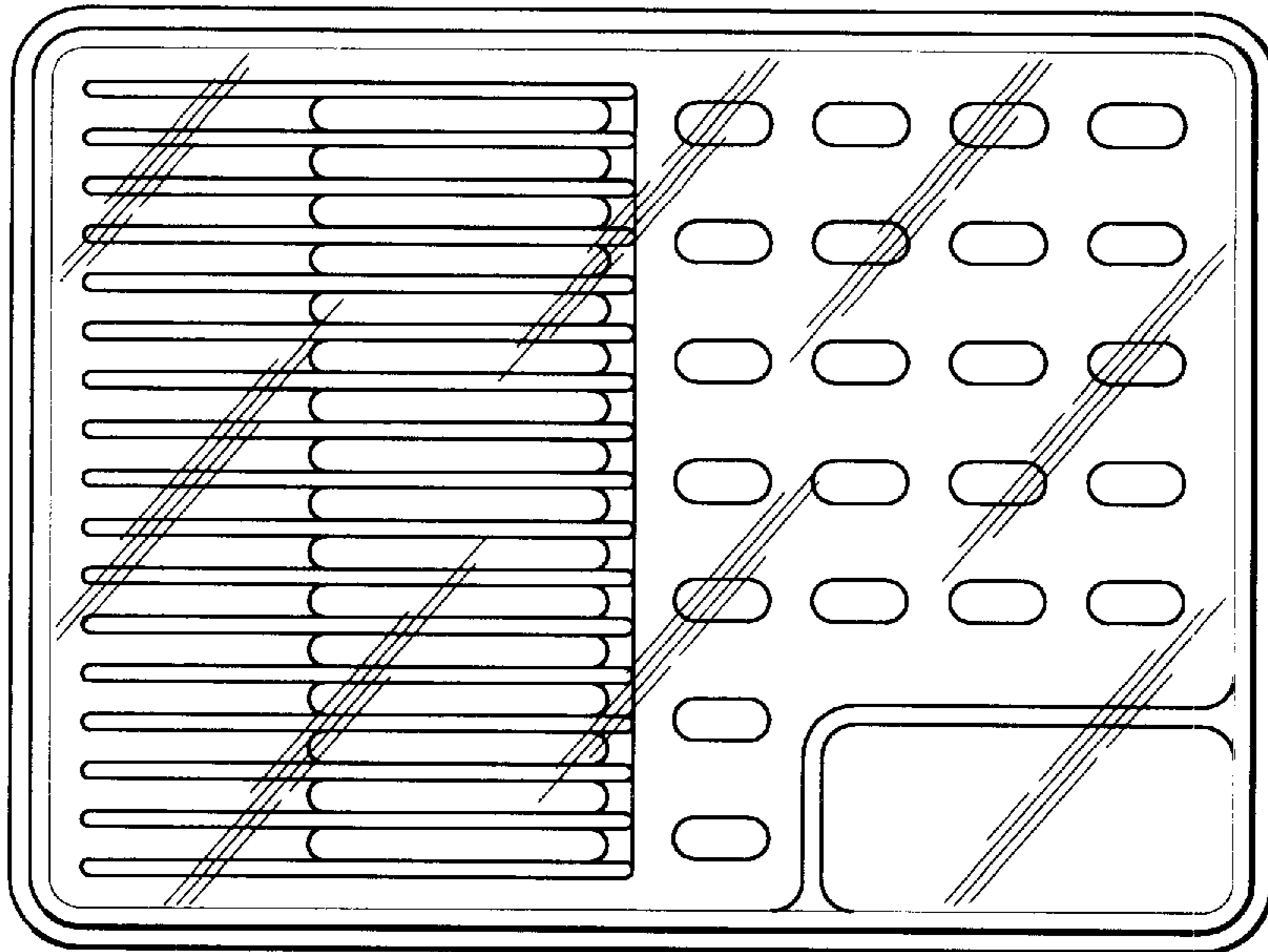

Fig. 2

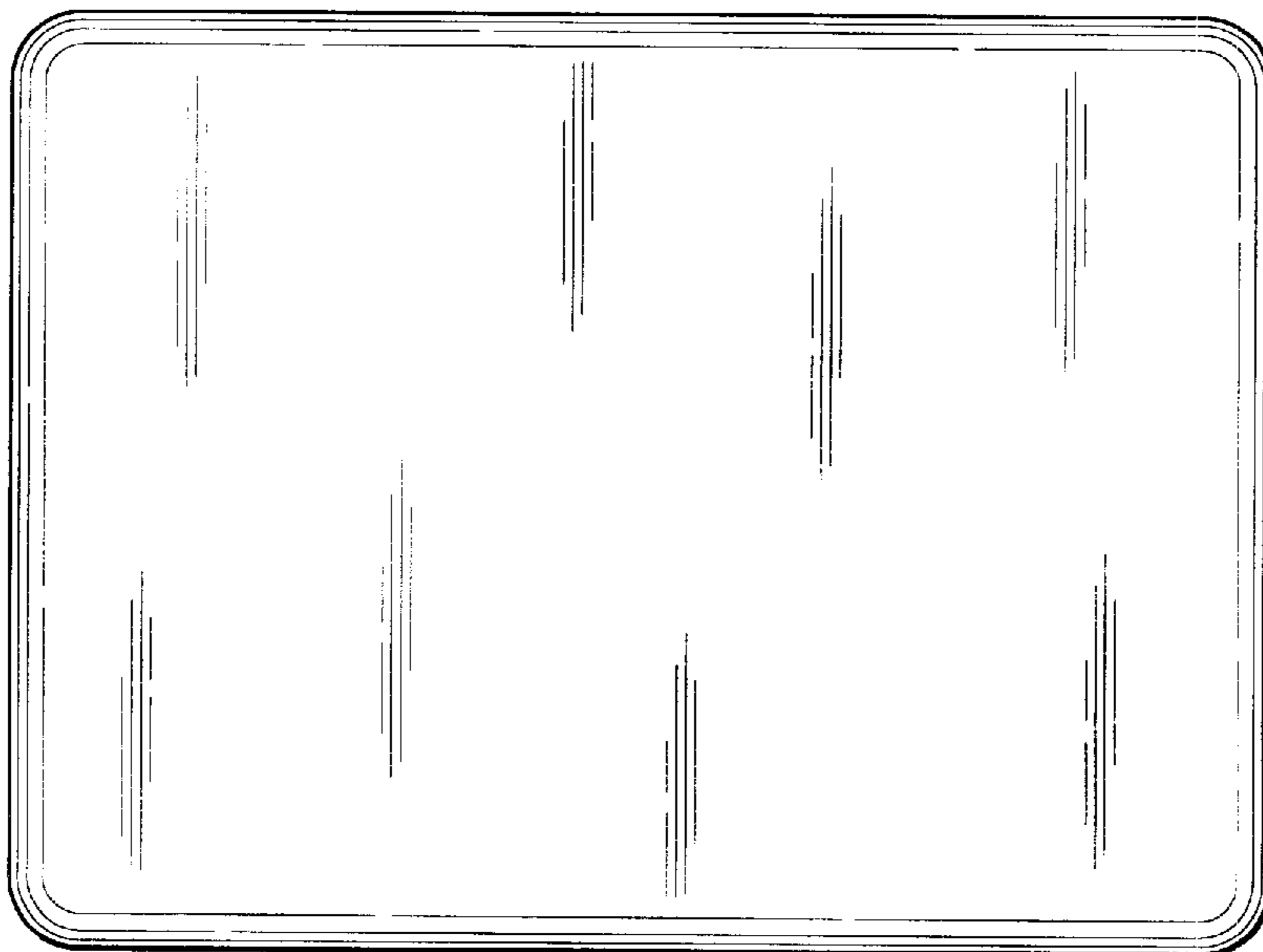

Fig. 3

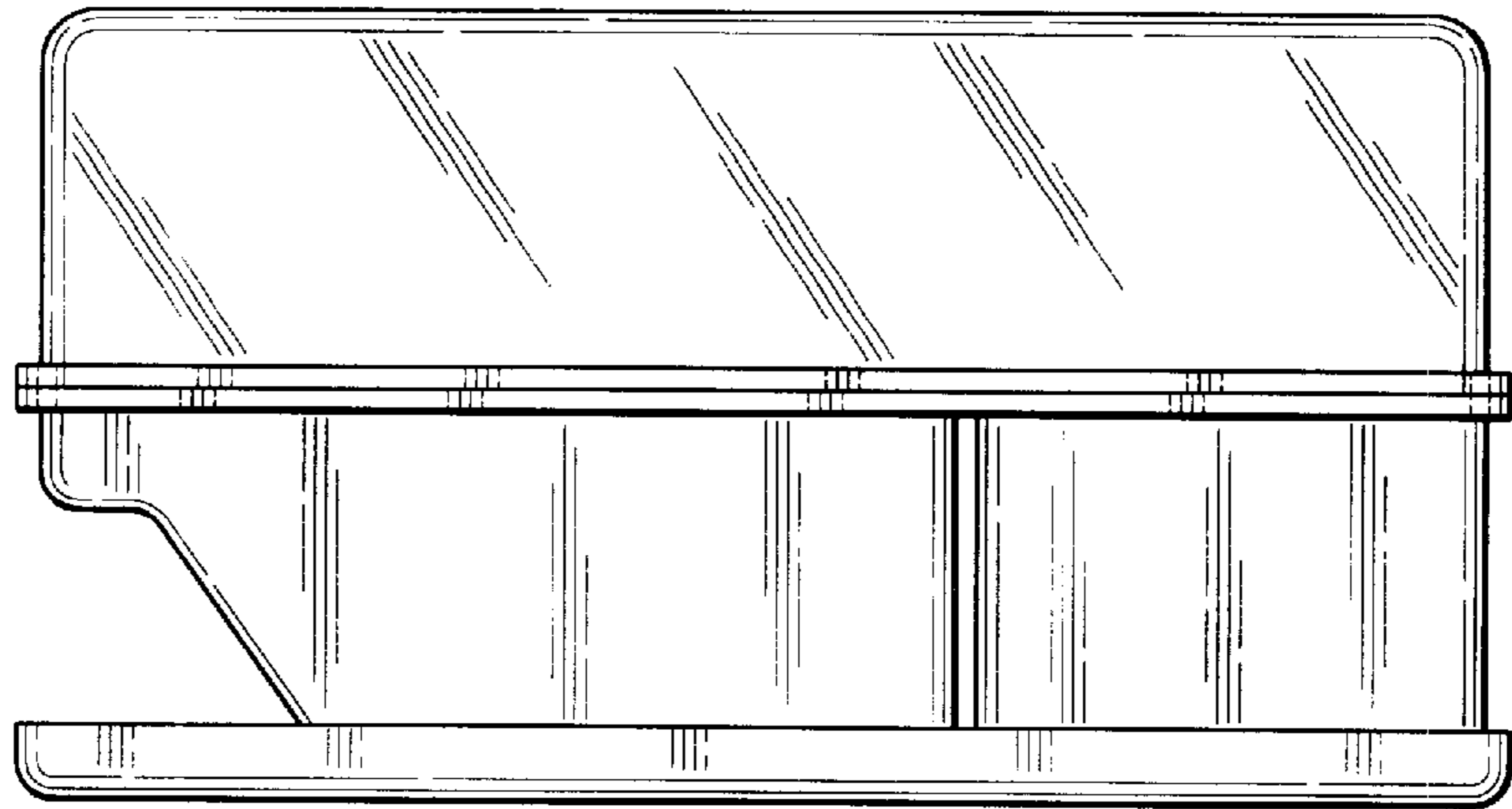

Fig. 4

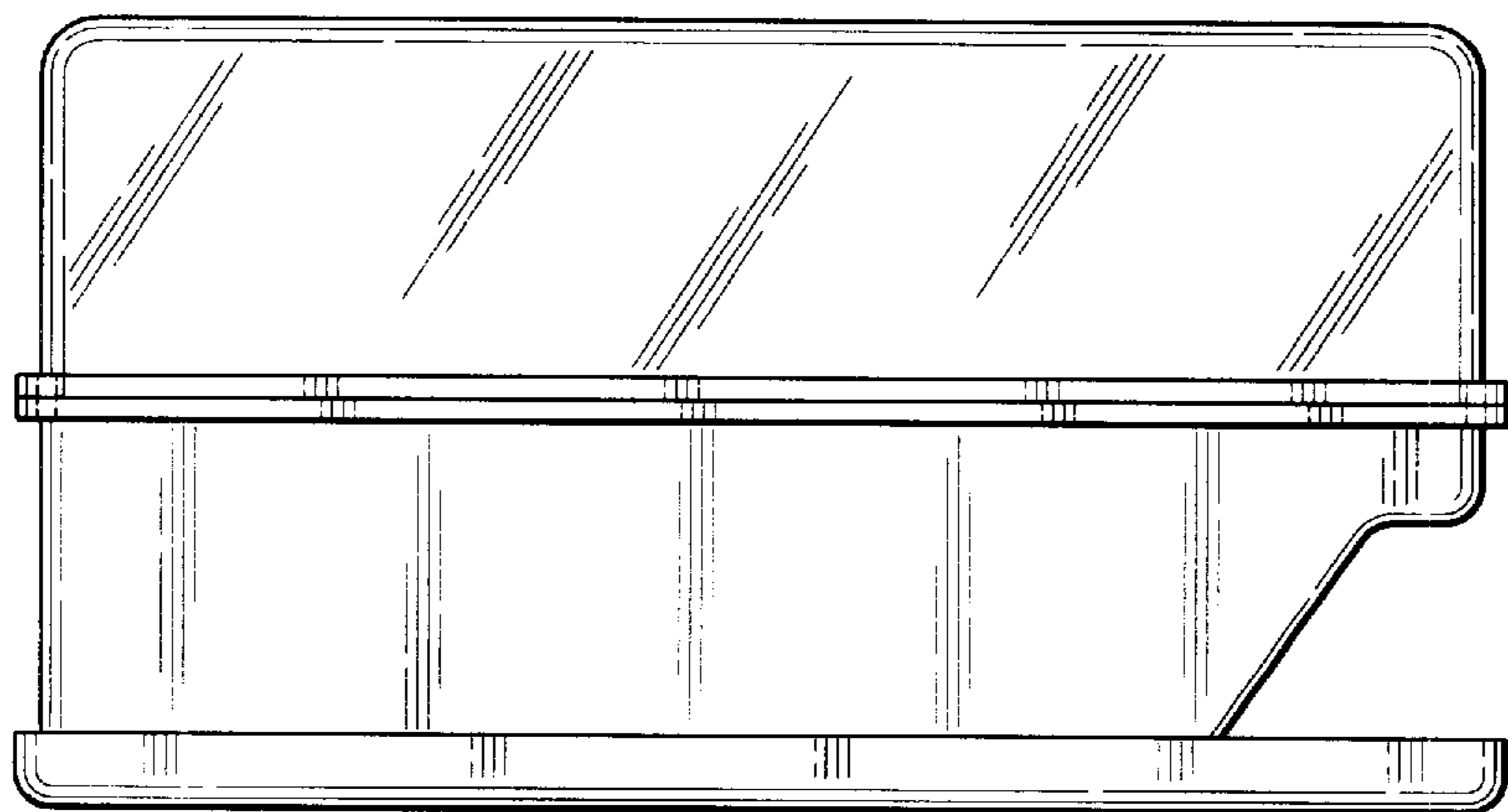

Fig. 5

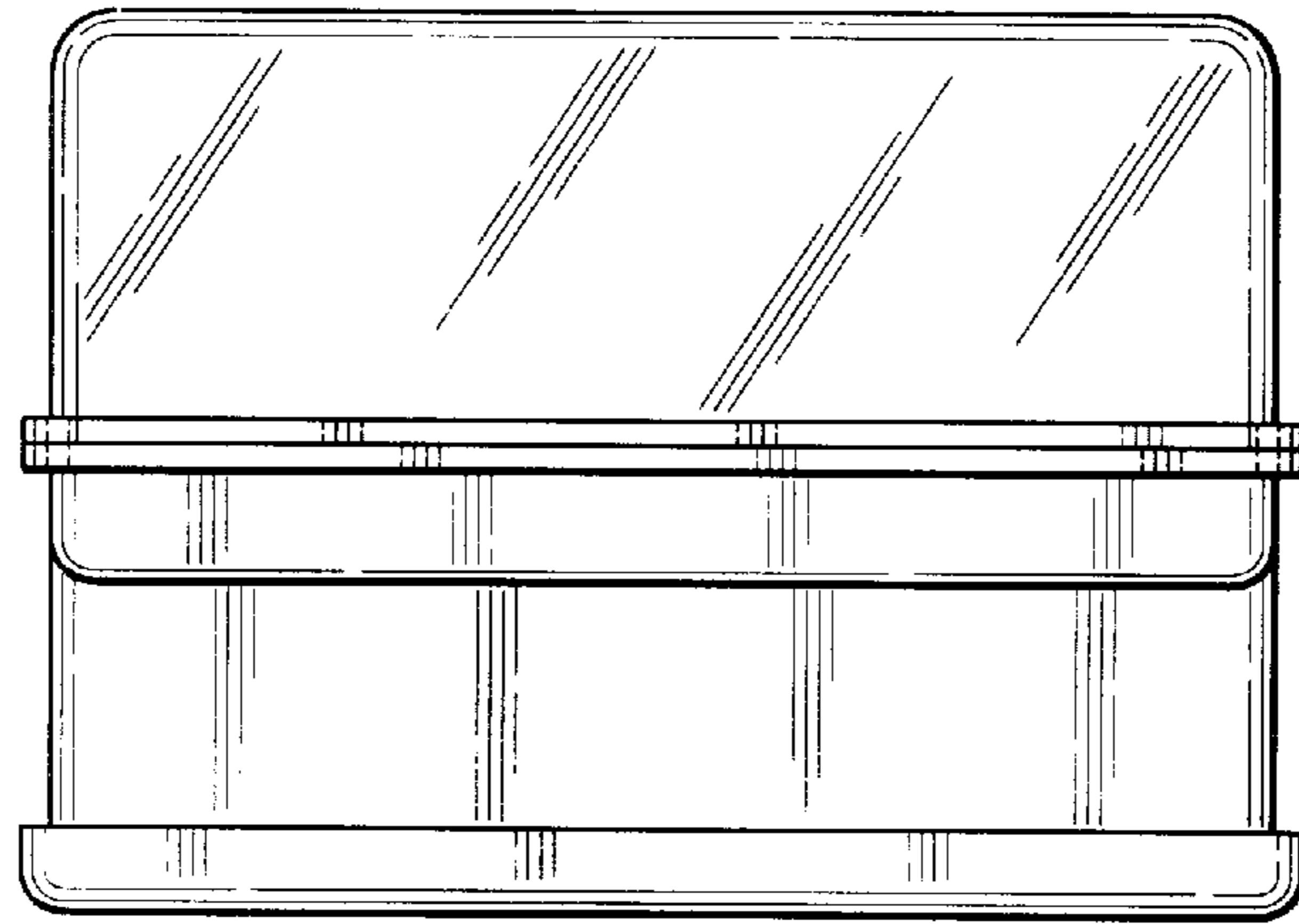

Fig. 6

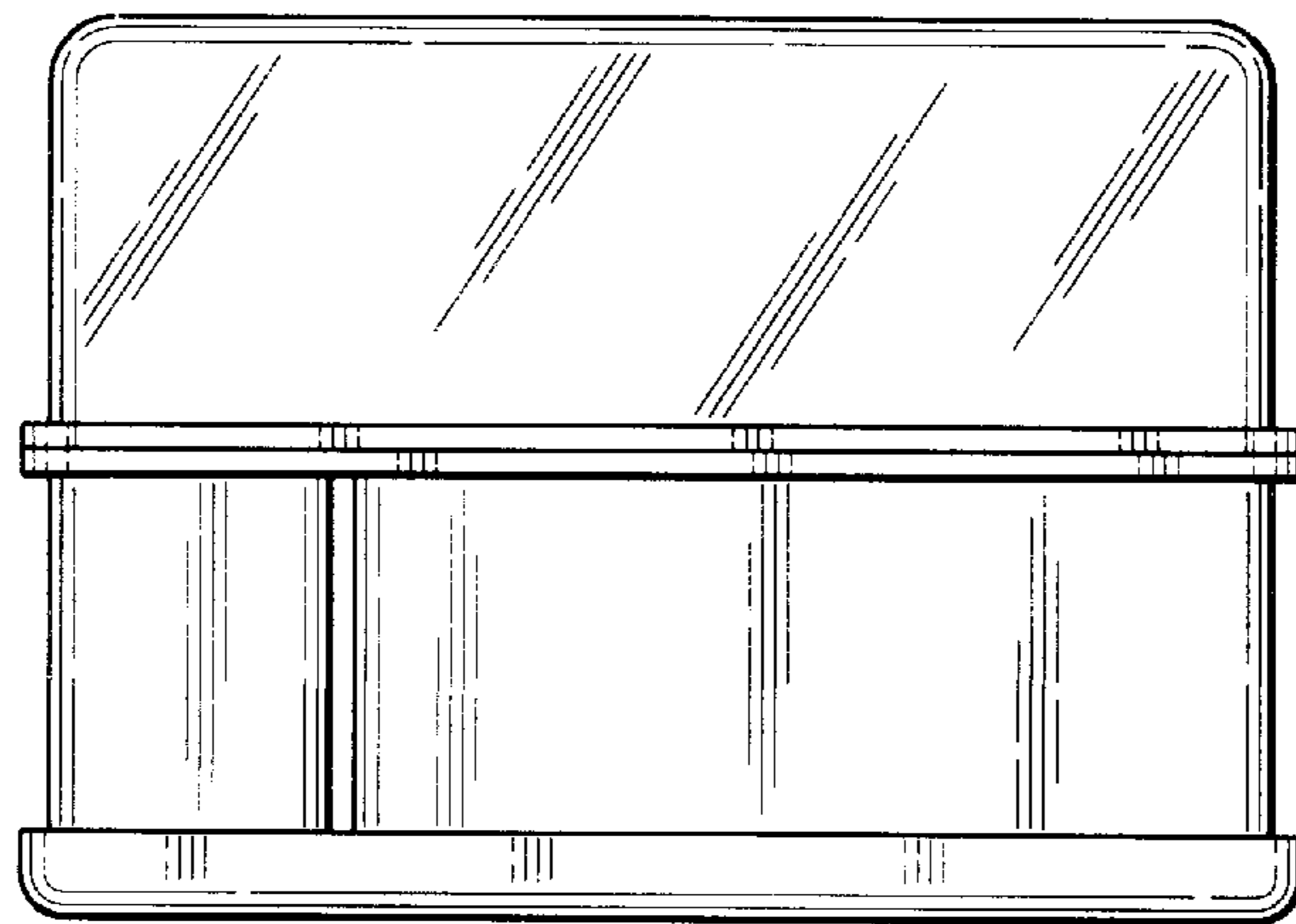

Fig. 7