



US00D407831S

**United States Patent** [19]  
**Gifford**

[11] **Patent Number: Des. 407,831**

[45] **Date of Patent: \*\*Apr. 6, 1999**

[54] **WINDOW MOLDING EXTRUSION**

*Attorney, Agent, or Firm—Baker & Daniels*

[76] Inventor: **Thomas E. Gifford**, P.O. Box 2118,  
Elkhart, Ind. 46515

[57] **CLAIM**

The ornamental design for a window molding extrusion, as shown and described.

[\*\*] Term: **14 Years**

[21] Appl. No.: **69,300**

**DESCRIPTION**

[22] Filed: **Mar. 26, 1997**

FIG. 1 is a perspective view of a window molding extrusion illustrating my new design;

[51] **LOC (6) Cl. .... 25-01**

[52] **U.S. Cl. .... D25/136; D25/119**

FIG. 2 is a perspective view of the window molding extrusion of FIG. 1 shown installed on the perimeter of window of a residential structure; the broken lines are for environmental purposes only and form no part of the claimed design;

[58] **Field of Search** ..... D25/136, 119,  
D25/164, 52; 52/800.11, 800.12, 799.11,  
717.03, 717.01, 717.02, 716.1, 108, 211,  
717.05, 716.8

[56] **References Cited**

FIG. 3 is a front view of the window molding extrusion shown in FIGS. 1 and 2;

**U.S. PATENT DOCUMENTS**

FIG. 4 is a rear view thereof;

D. 27,016	5/1897	Woods	.....	D25/164
2,163,613	6/1939	Manofsky	.....	D25/164
5,247,769	9/1993	Becker	.....	52/716.8
5,282,344	2/1994	Moore	.....	52/717.01

FIG. 5 is a cross-sectional view of uniform proportions of the window molding extrusion shown in FIGS. 1 through 4 taken along sectional lines 5—5 of FIG. 3; and,

**OTHER PUBLICATIONS**

FIG. 6 is a top plan view of the window molding extrusion shown in FIGS. 1 through 5.

Dahlstrom Metal Moldings & Shapes Catalog, dated 1969  
Section 1, p. 30, molding on top left of page.

*Primary Examiner—Doris Clark*

**1 Claim, 4 Drawing Sheets**

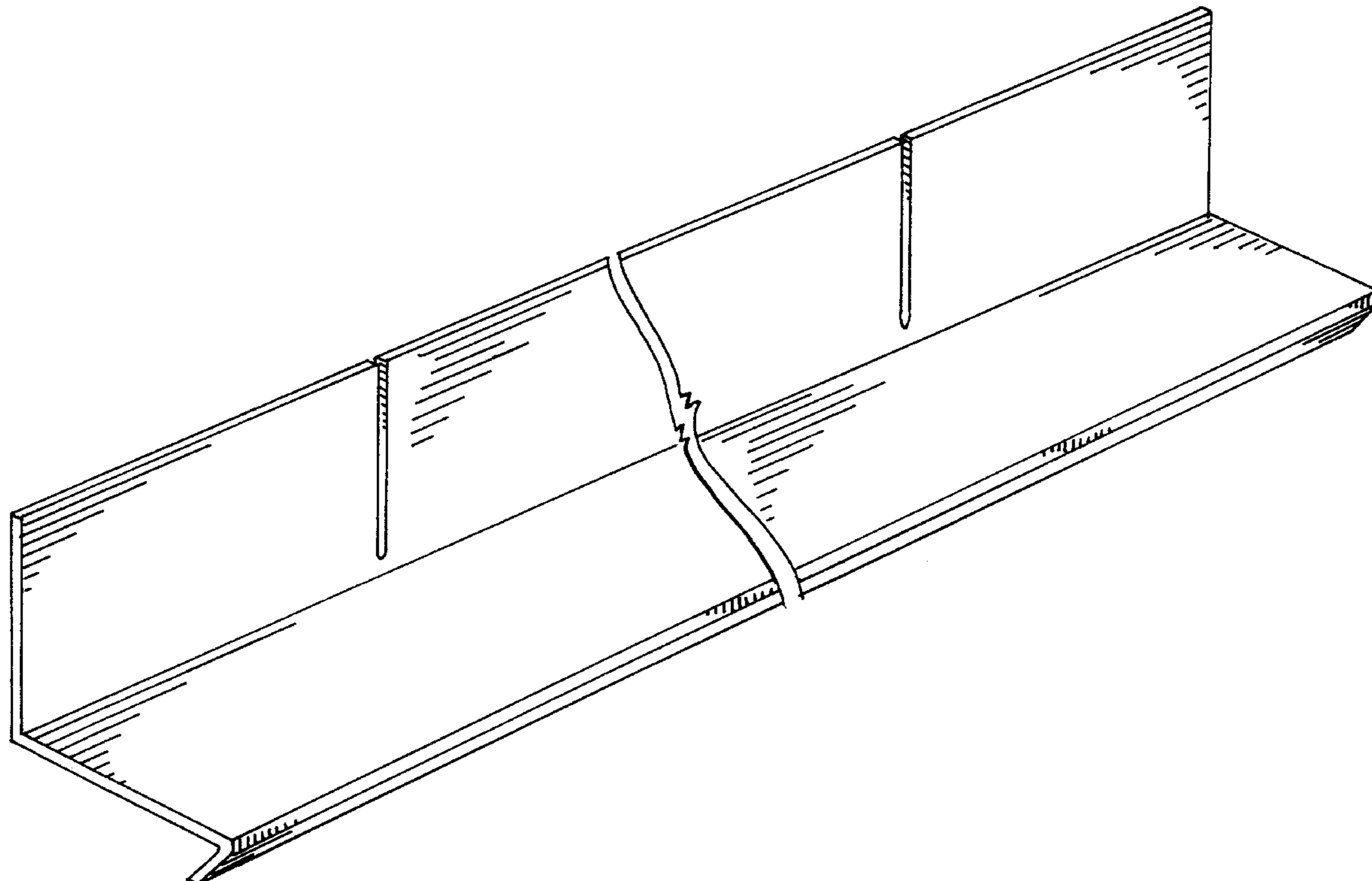

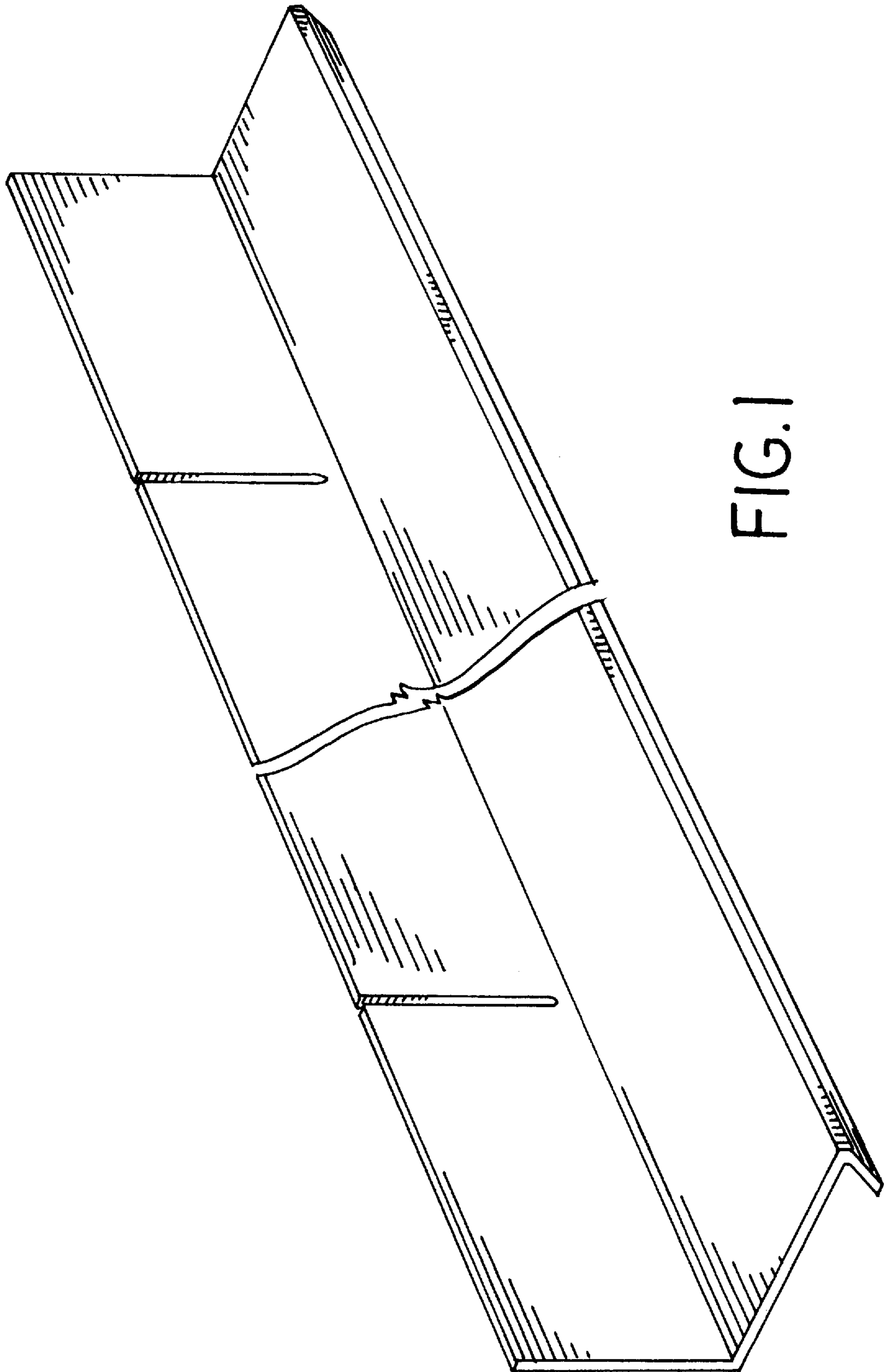
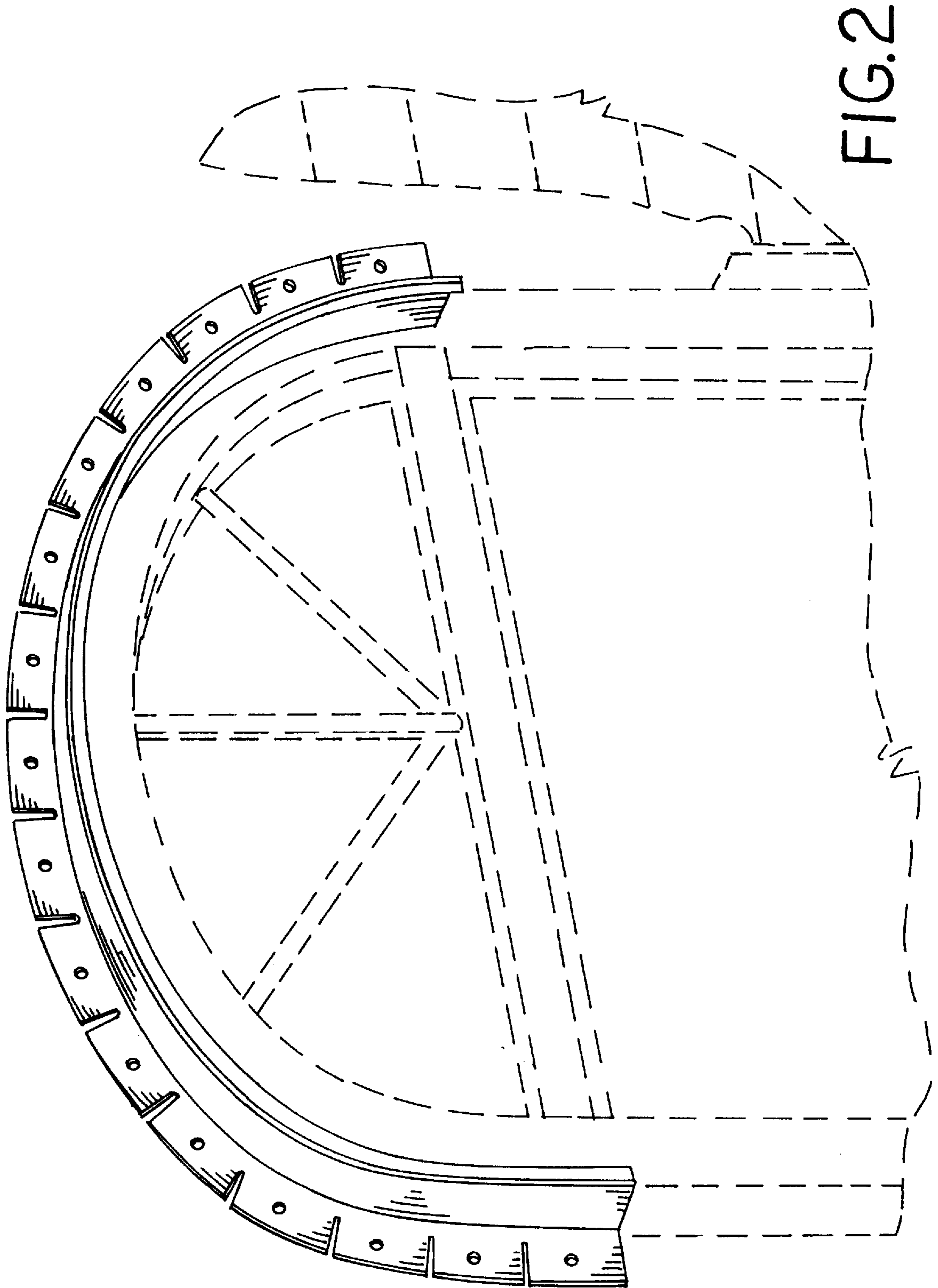

FIG. 1



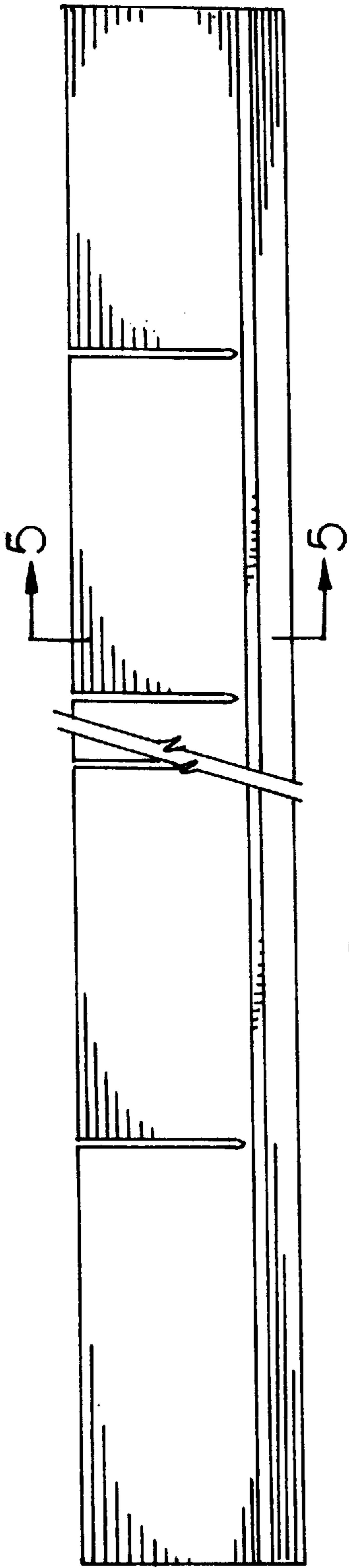

FIG. 3

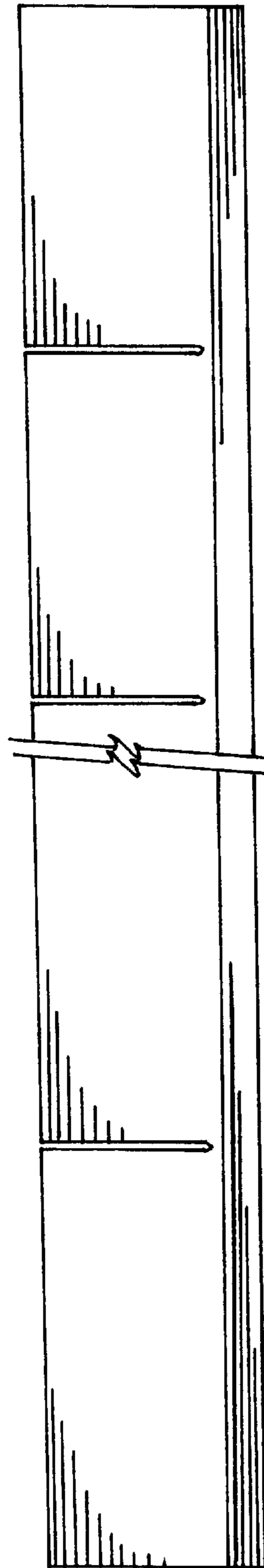

FIG. 4

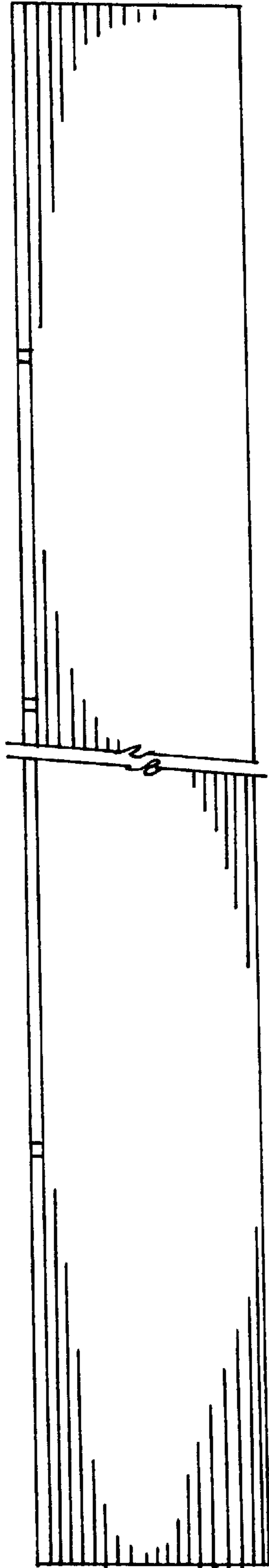

FIG. 6

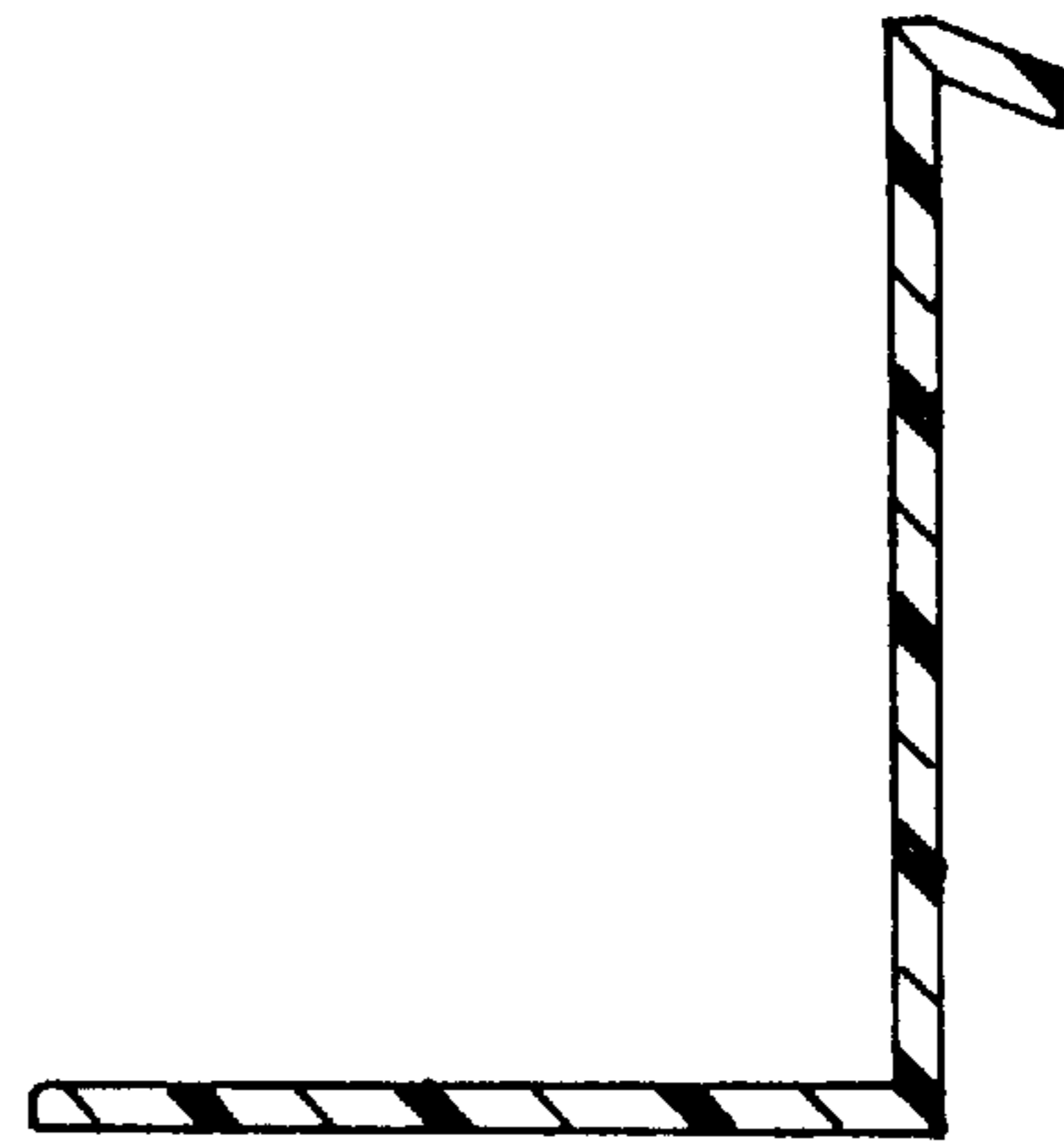

FIG. 5