



US00D407817S

United States Patent [19]

[11] **Patent Number: Des. 407,817**

Macauley et al.

[45] **Date of Patent: ***Apr. 6, 1999**

[54] **BOTTLE AND CLOSURE**

[75] Inventors: **Richard Peter Macauley**, Westerville; **Patrick Edward McCallister**, Columbus, both of Ohio; **Jay Andrew Smithberger**, Evanston, Ill.; **Lewis Henry Sita**, Worthington; **Elwood Lamar Stokesbury**, Westerville, both of Ohio

[73] Assignee: **Abbott Laboratories**, Abbott Park, Ill.

[*] Notice: The term of this patent shall not extend beyond the expiration date of Pat. No. Des. 379,224.

[**] Term: **14 Years**

[21] Appl. No.: **41,268**

[22] Filed: **Jul. 10, 1995**

Related U.S. Application Data

[62] Division of Ser. No. 26,132, Jul. 20, 1994.

[51] **LOC (6) Cl.** **24-04**

[52] **U.S. Cl.** **D24/121**

[58] **Field of Search** D24/121, 224, D24/118, 127, 128; D9/520, 430, 573, 453, 572, 454, 445, 447; 215/329, 373, 215, 370, 374

References Cited

U.S. PATENT DOCUMENTS

D. 288,293	2/1987	Arvans	D9/370
D. 289,975	5/1987	Wendt	D9/401
D. 303,496	9/1989	Larson	D9/367
D. 304,805	11/1989	Mednis	D9/341
D. 313,177	12/1990	Larson	D9/370
D. 316,965	5/1991	Arvidson	D9/370
D. 330,332	10/1992	Pezzoli et al.	D9/435
D. 372,090	7/1996	MacCauley et al.	D24/224
D. 374,481	10/1996	McCallister et al.	D24/224 X
D. 376,424	12/1996	Macauley et al.	D24/121
D. 379,224	5/1997	McCallister et al.	D24/121
3,096,913	7/1963	Corley	222/183

3,171,412	3/1965	Braun	123/272
3,325,031	6/1967	Singier	215/37
3,384,258	5/1968	Singier	215/100
3,537,498	11/1970	St. Amand	150/0.5
3,581,928	6/1971	St. Amand	215/100 A
3,926,341	12/1975	Lhoest	222/92
4,013,187	3/1977	Betka	3215/100
4,747,519	5/1988	Green et al.	222/181
4,830,970	5/1989	Madaus et al.	D24/224 X
4,934,545	6/1990	Pezzoli et al.	215/250
4,951,845	8/1990	Pezzoli et al.	215/250
5,123,554	6/1992	Arvidson	215/12.2

Primary Examiner—Louis S. Zarfaz
Assistant Examiner—Eric Watterson
Attorney, Agent, or Firm—Brian R. Woodworth

[57] CLAIM

The ornamental design for a bottle and closure, as shown and described.

DESCRIPTION

FIG. 1 is a perspective view of a bottle and closure showing our new design;

FIG. 2 is another perspective view thereof from the opposite direction of that shown in FIG. 1;

FIG. 3 is a front elevation thereof;

FIG. 4 is a rear elevation thereof;

FIG. 5 is a top view thereof;

FIG. 6 is a bottom view thereof;

FIG. 7 is a first side elevation thereof;

FIG. 8 is a second side elevation thereof for the side opposite that shown in FIG. 7;

FIG. 9 is a perspective view of a second embodiment of a bottle and closure showing our new design;

FIG. 10 is another perspective view thereof from the opposite side direction of that shown in FIG. 9;

FIG. 11 is a front elevation thereof;

FIG. 12 is a rear elevation thereof;

FIG. 13 is a top view thereof;

FIG. 14 is a bottom view thereof;

FIG. 15 is a first side elevation thereof;

FIG. 16 is a second side elevation thereof for the side opposite that shown in FIG. 15;

FIG. 17 is a perspective view of a third embodiment of a bottle and closure showing our new design;

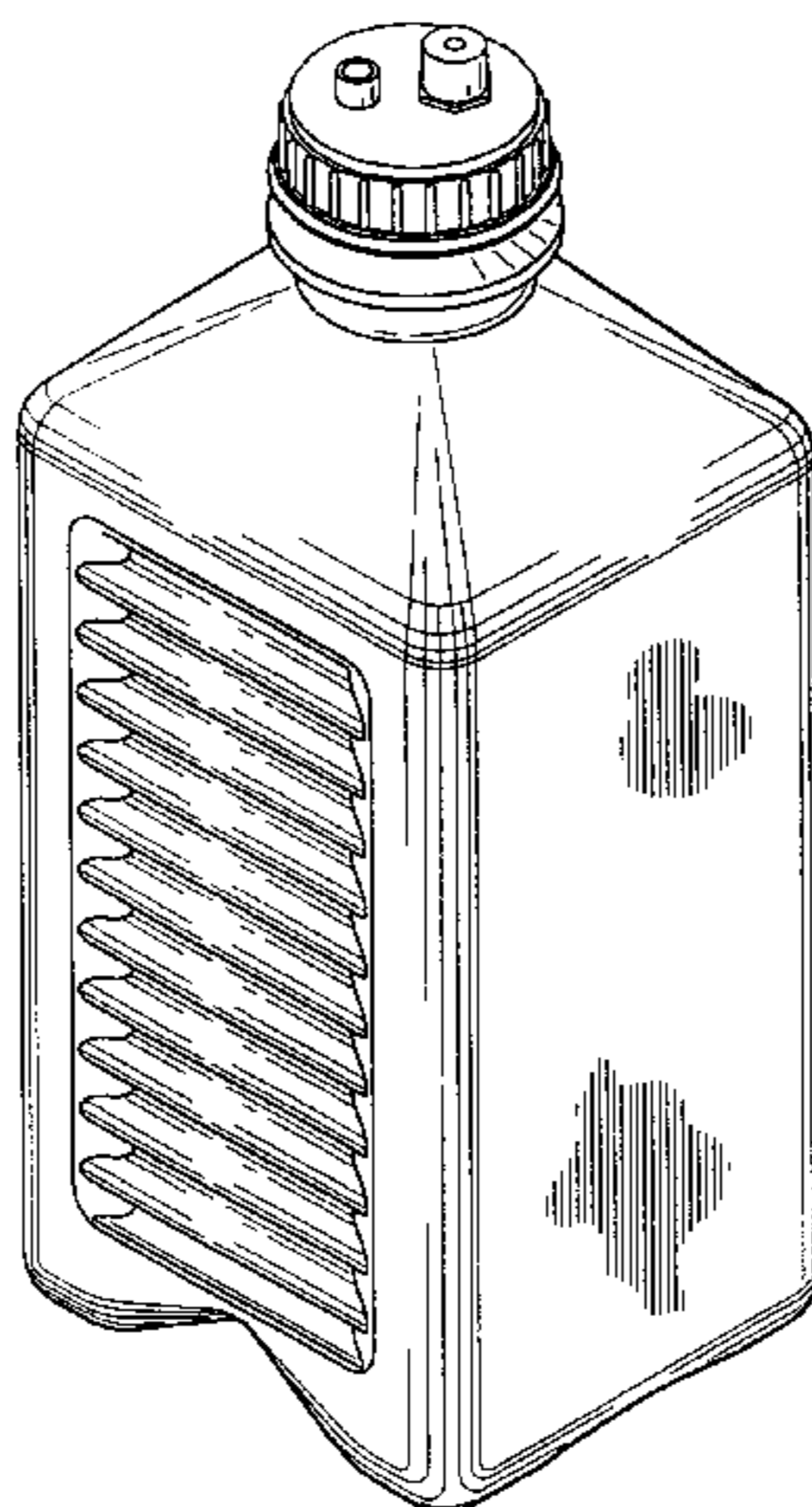

FIG. 18 is another perspective view thereof, from the opposite direction of that shown in FIG. 17;

FIG. 19 is a front elevation thereof;

FIG. 20 is a rear elevation thereof;

FIG. 21 is a top view thereof;

FIG. 22 is a bottom view thereof;

FIG. 23 is a side elevation thereof, the opposite side elevation being the same;

FIG. 24 is a perspective view of a fourth embodiment of a bottle and closure showing our new design;

FIG. 25 is another perspective view thereof from the opposite direction of that shown in FIG. 24;

FIG. 26 is a front elevation thereof;

FIG. 27 is a rear elevation thereof;

FIG. 28 is a top view thereof;

FIG. 29 is a bottom view thereof;

FIG. 30 is a first side elevation thereof;

FIG. 31 is a second side elevation thereof for the side opposite that shown in FIG. 30;

FIG. 32 is a perspective view of a fifth embodiment of a bottle and closure showing our new design;

FIG. 33 is another perspective view thereof from the opposite direction of that shown in FIG. 32;

FIG. 34 is a front elevation thereof;

FIG. 35 is a rear elevation thereof;

FIG. 36 is a top view thereof;

FIG. 37 is a bottom view thereof; and,

FIG. 38 is a side elevation thereof, the opposite side elevation being the same.

1 Claim, 20 Drawing Sheets

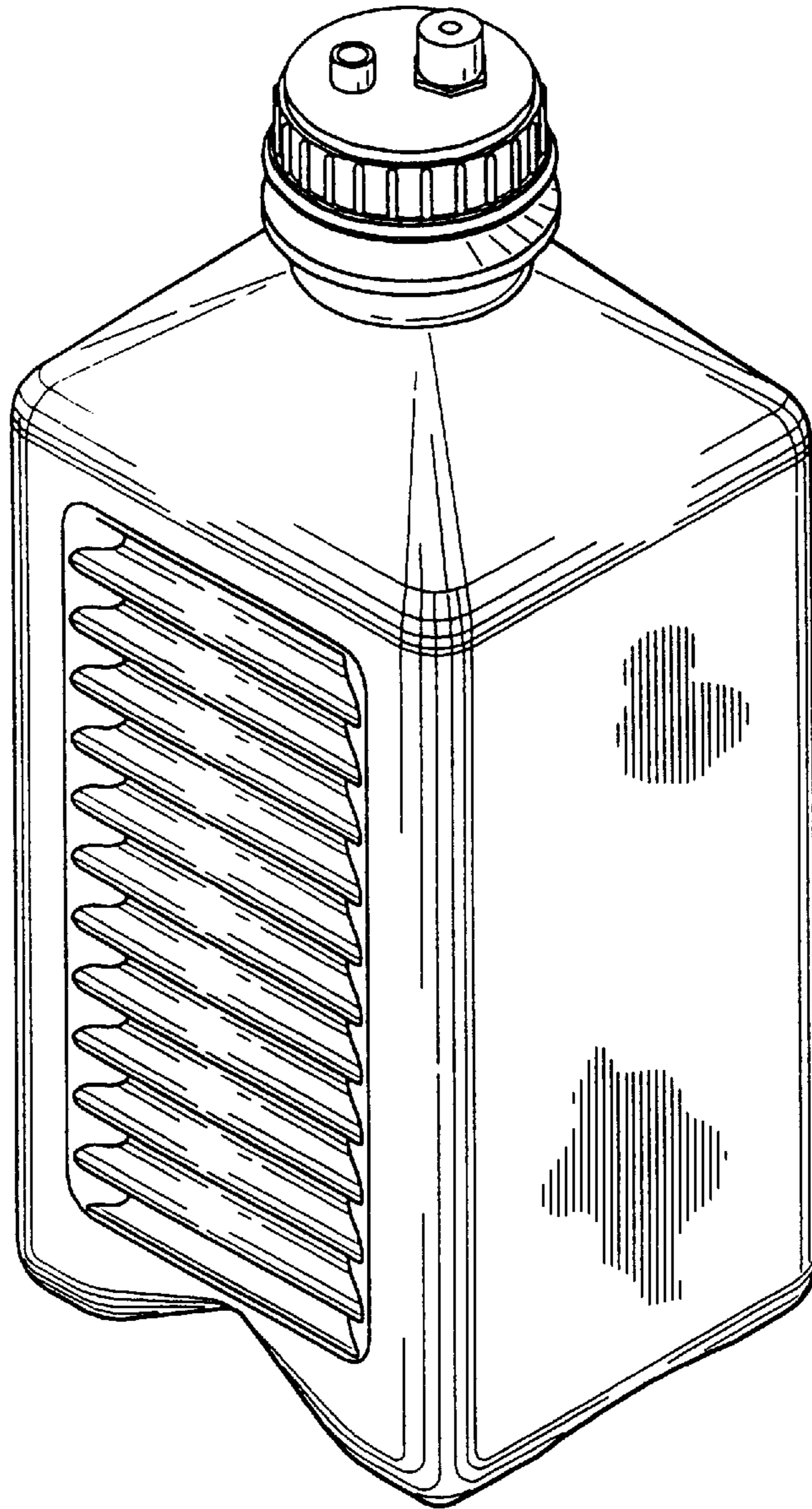

FIG. 1

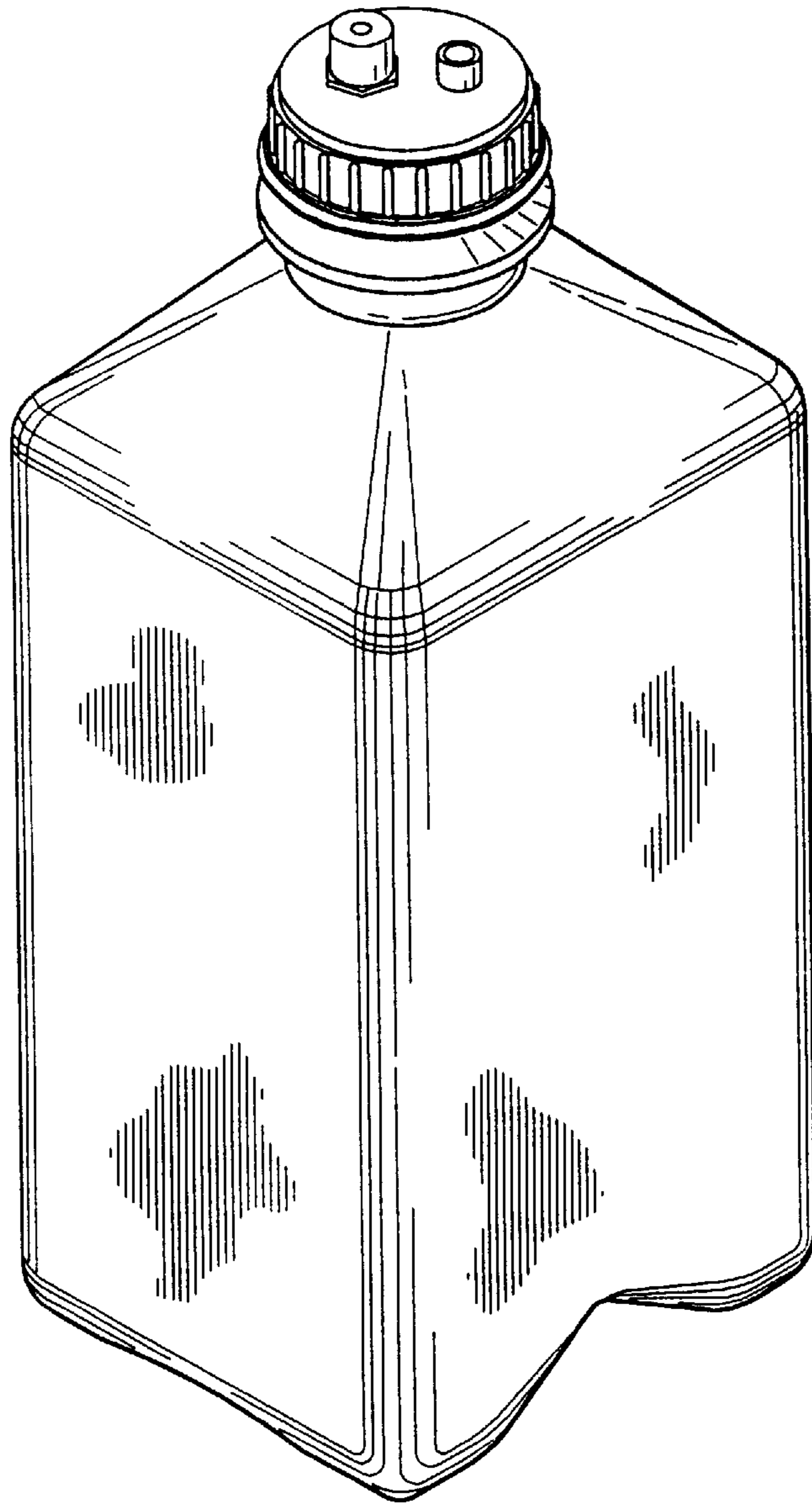

FIG. 2

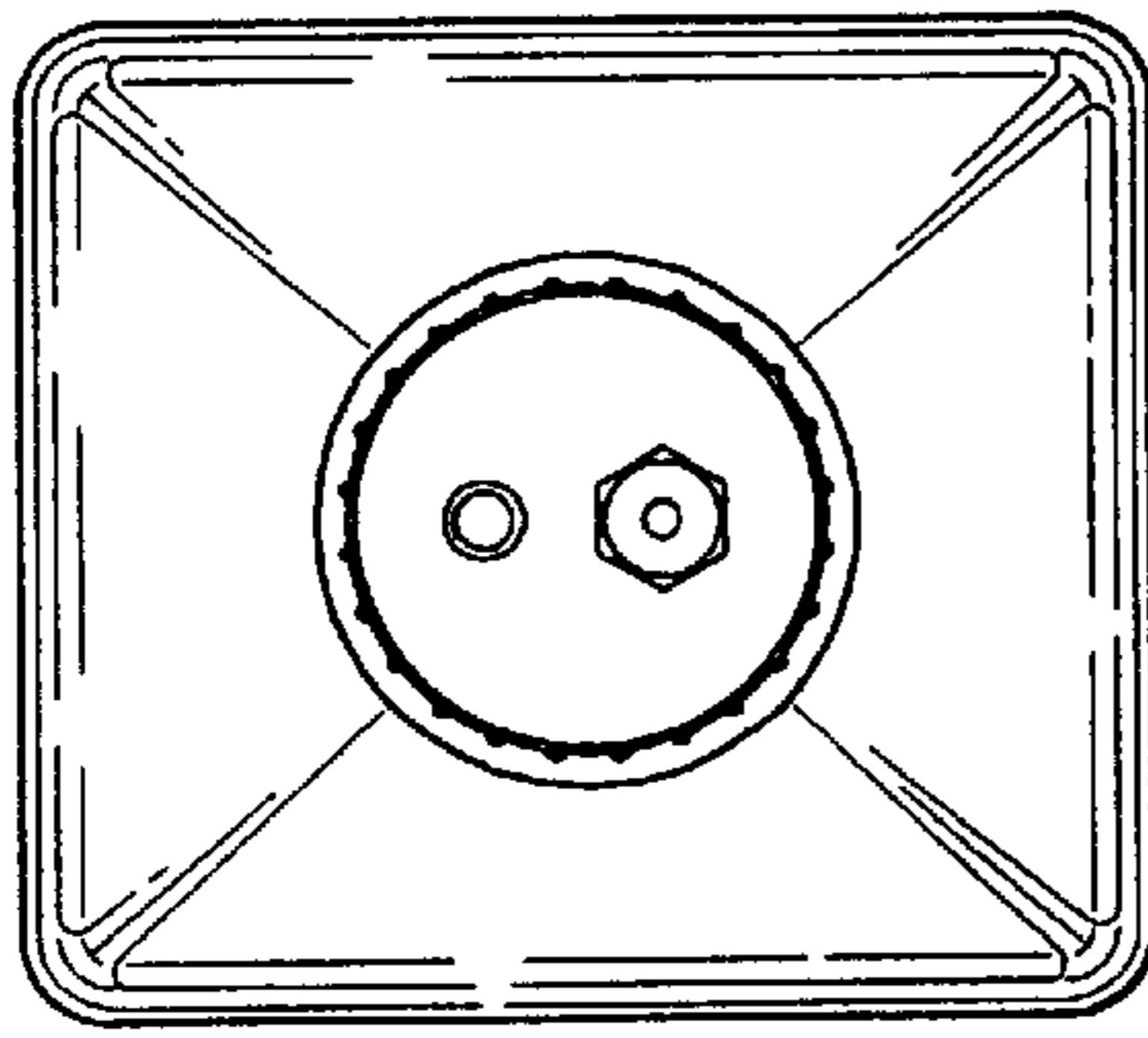

FIG. 5

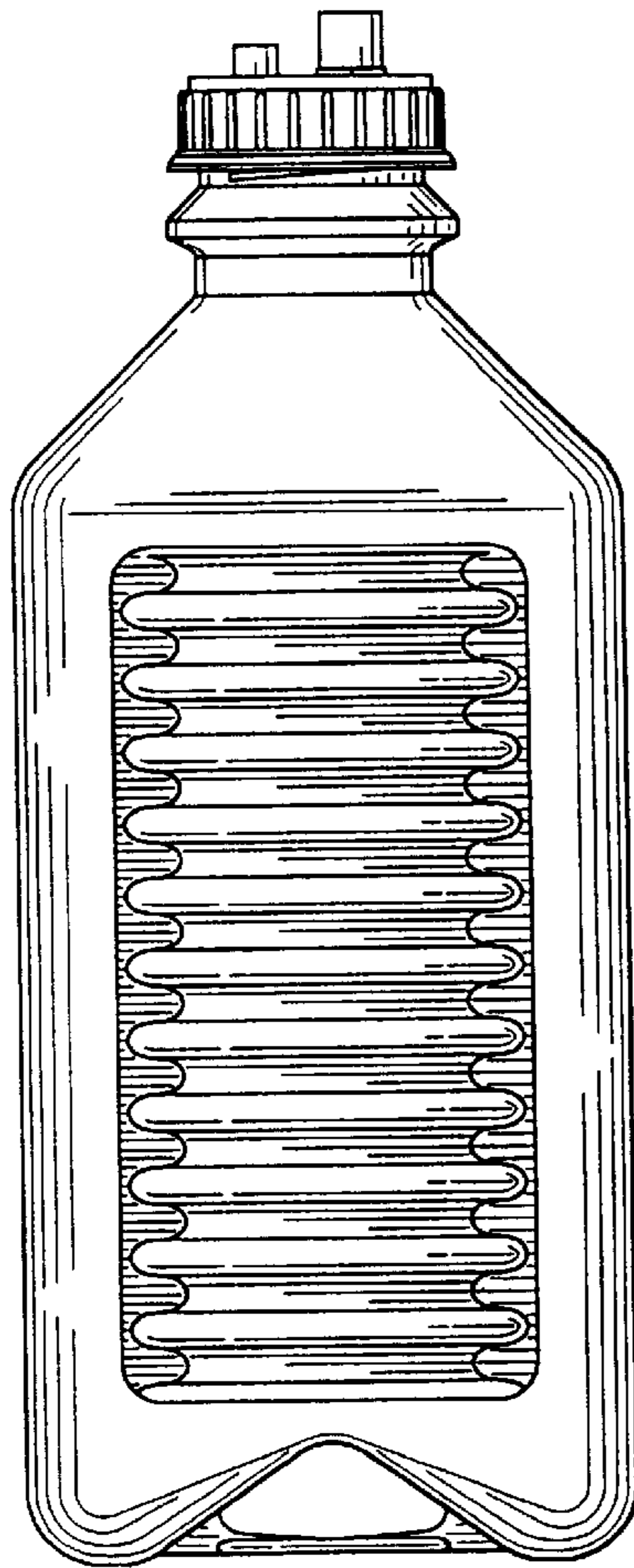

FIG. 3

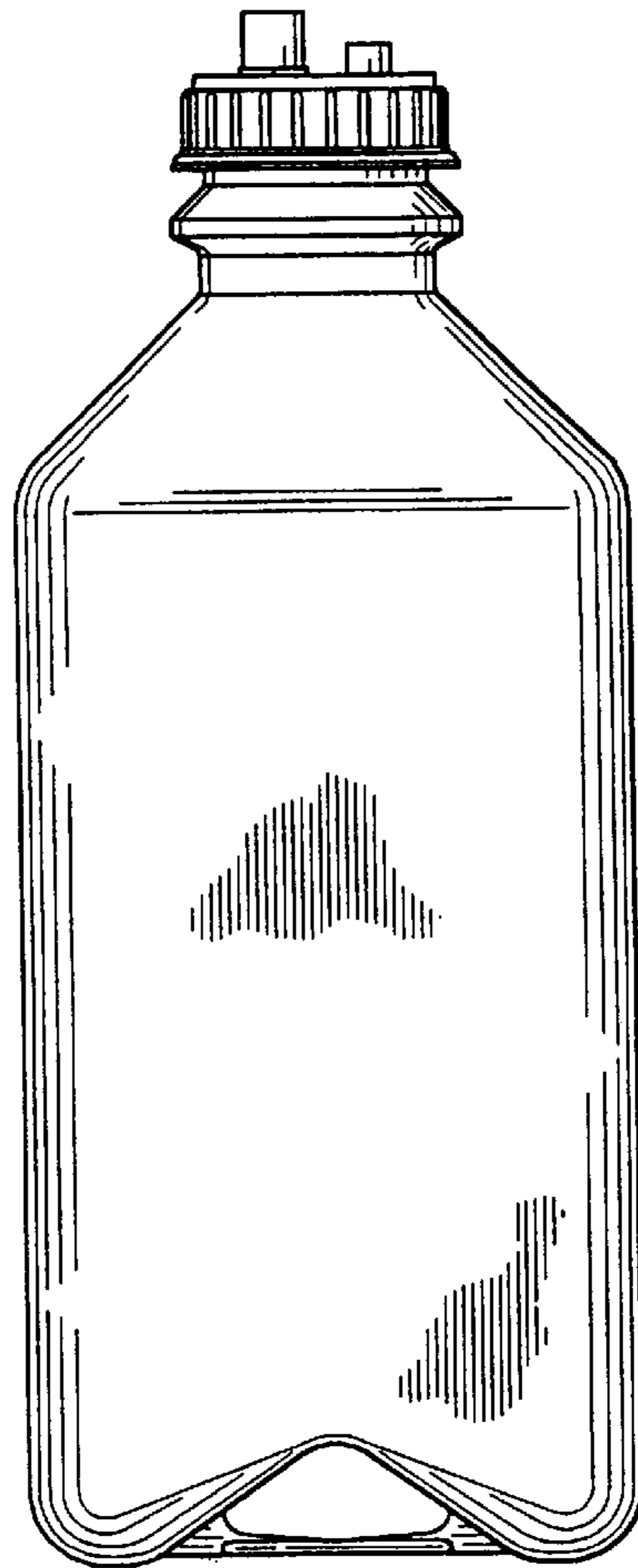

FIG. 4

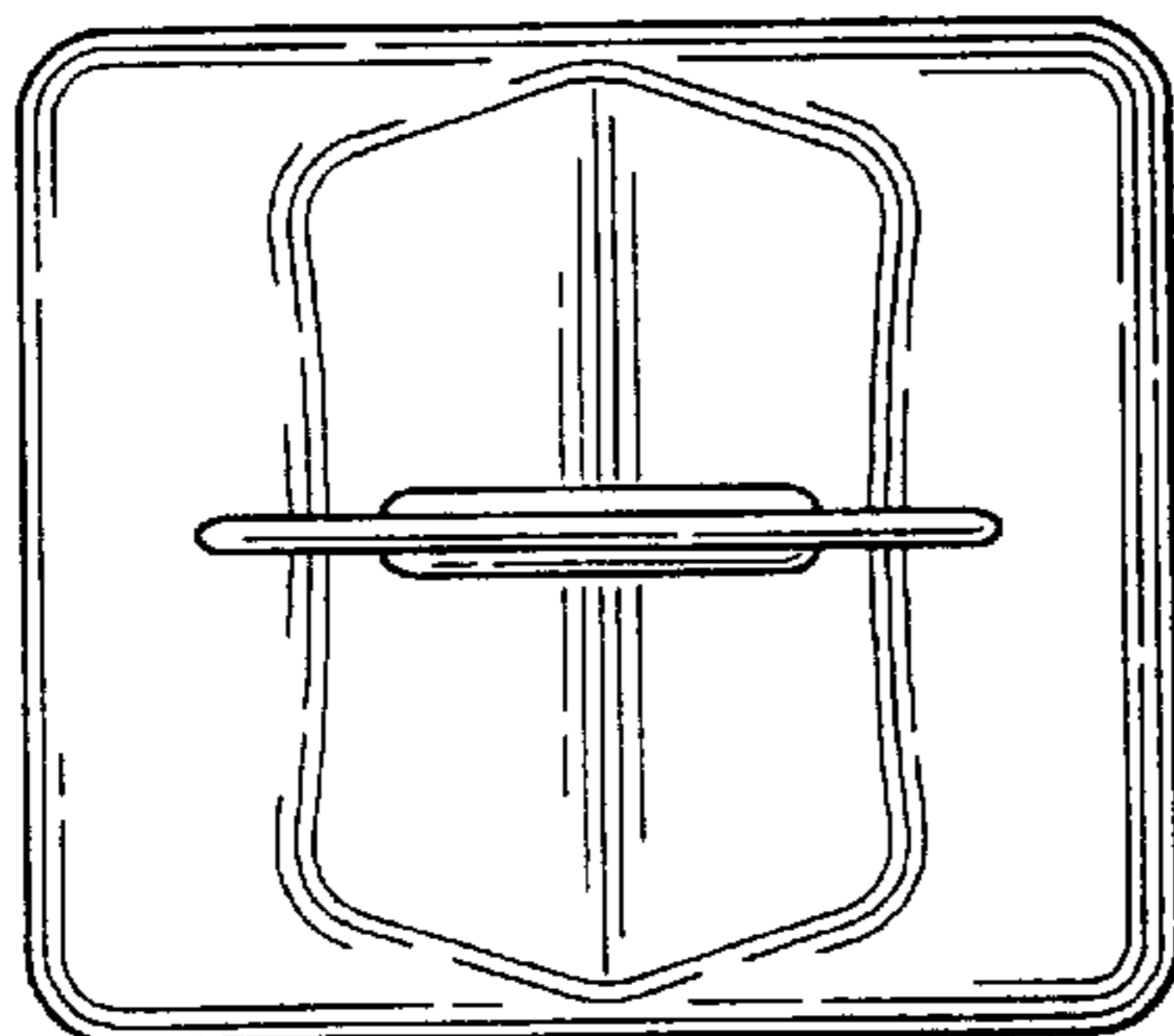

FIG. 6

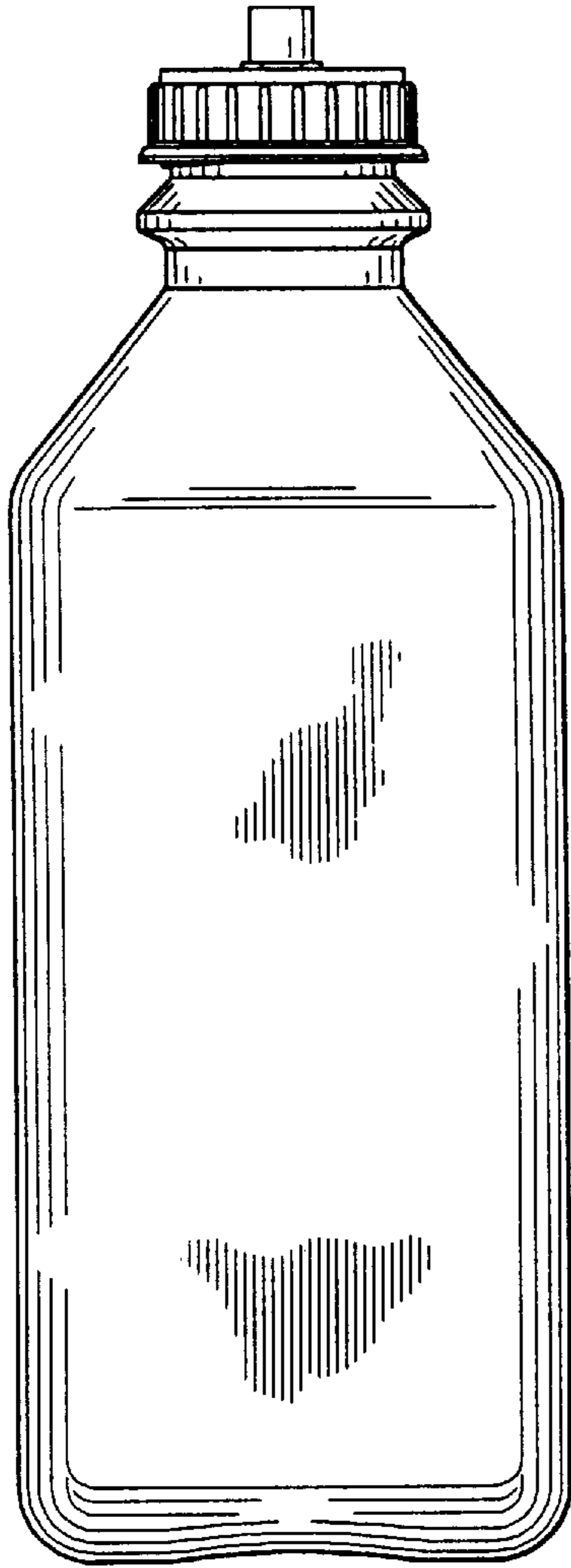

FIG. 7

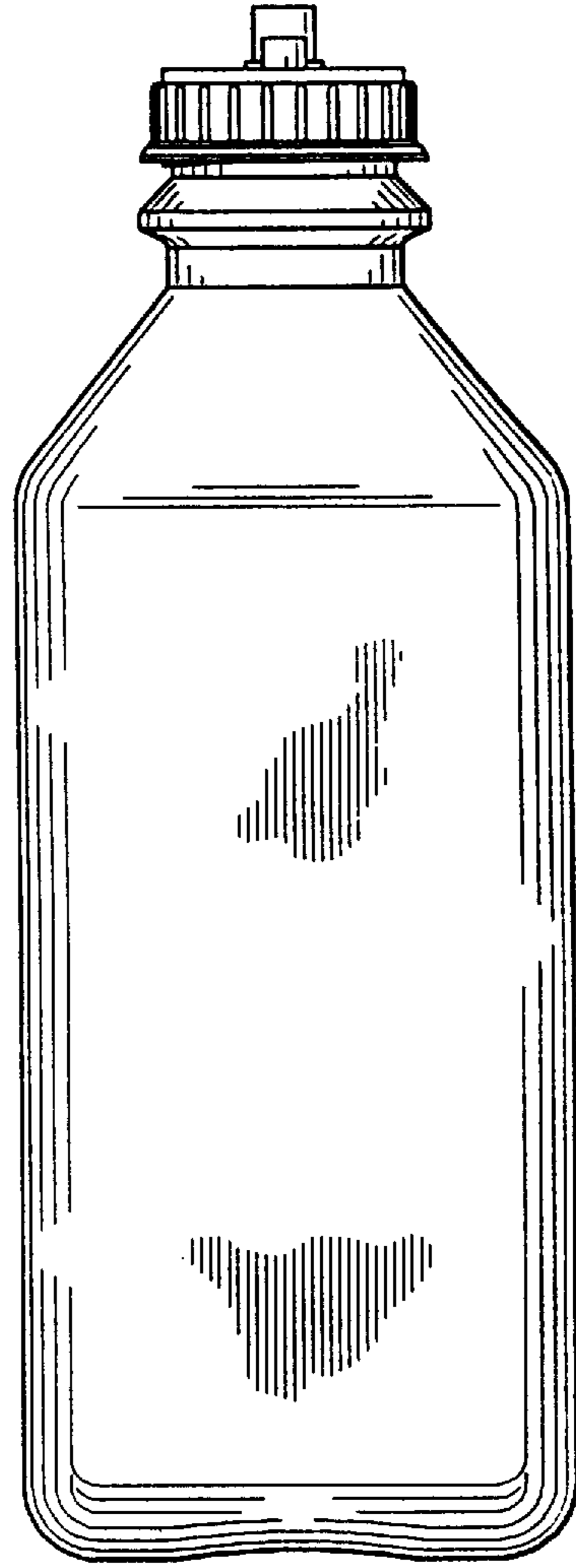

FIG. 8

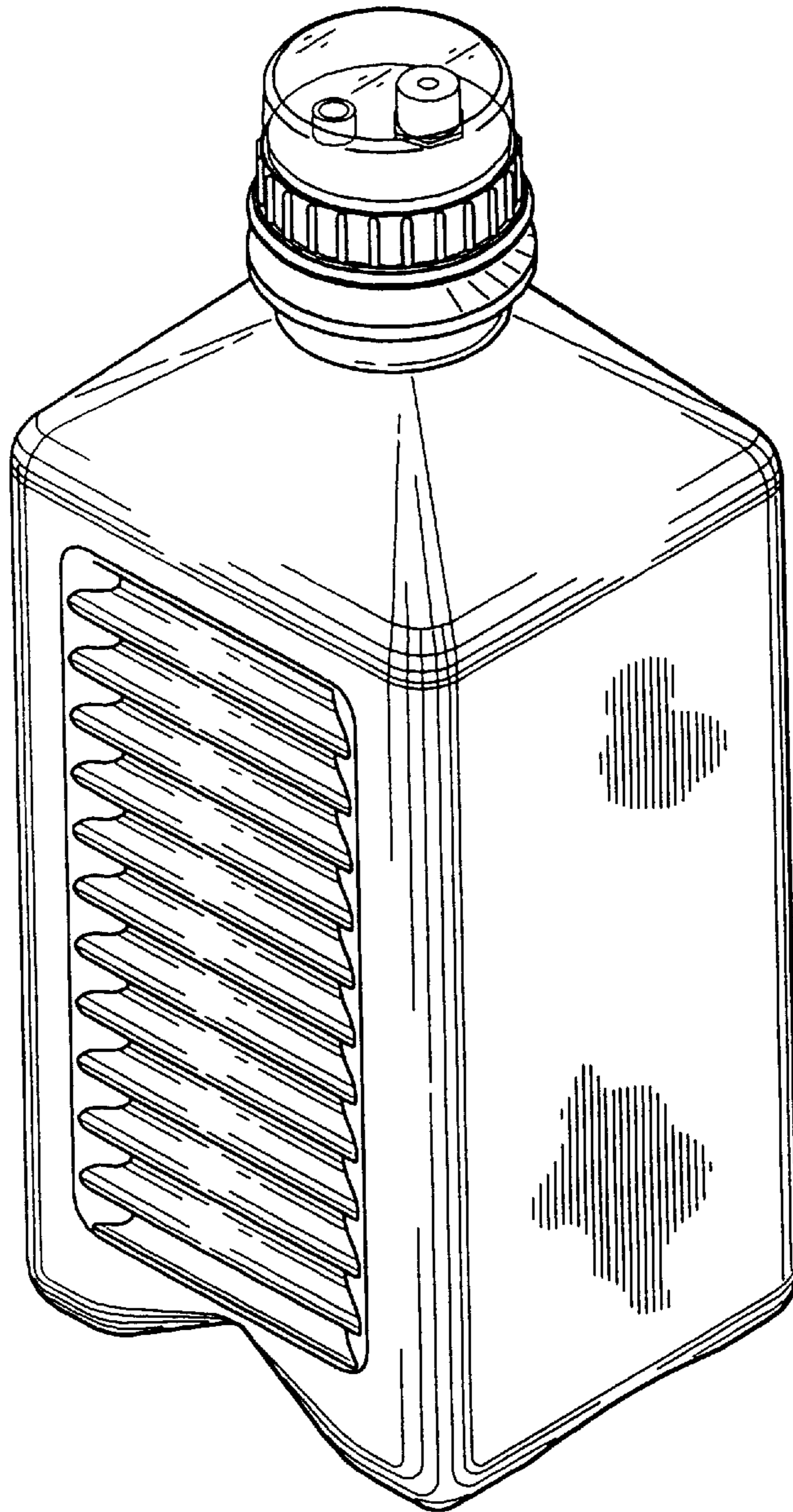

FIG. 9

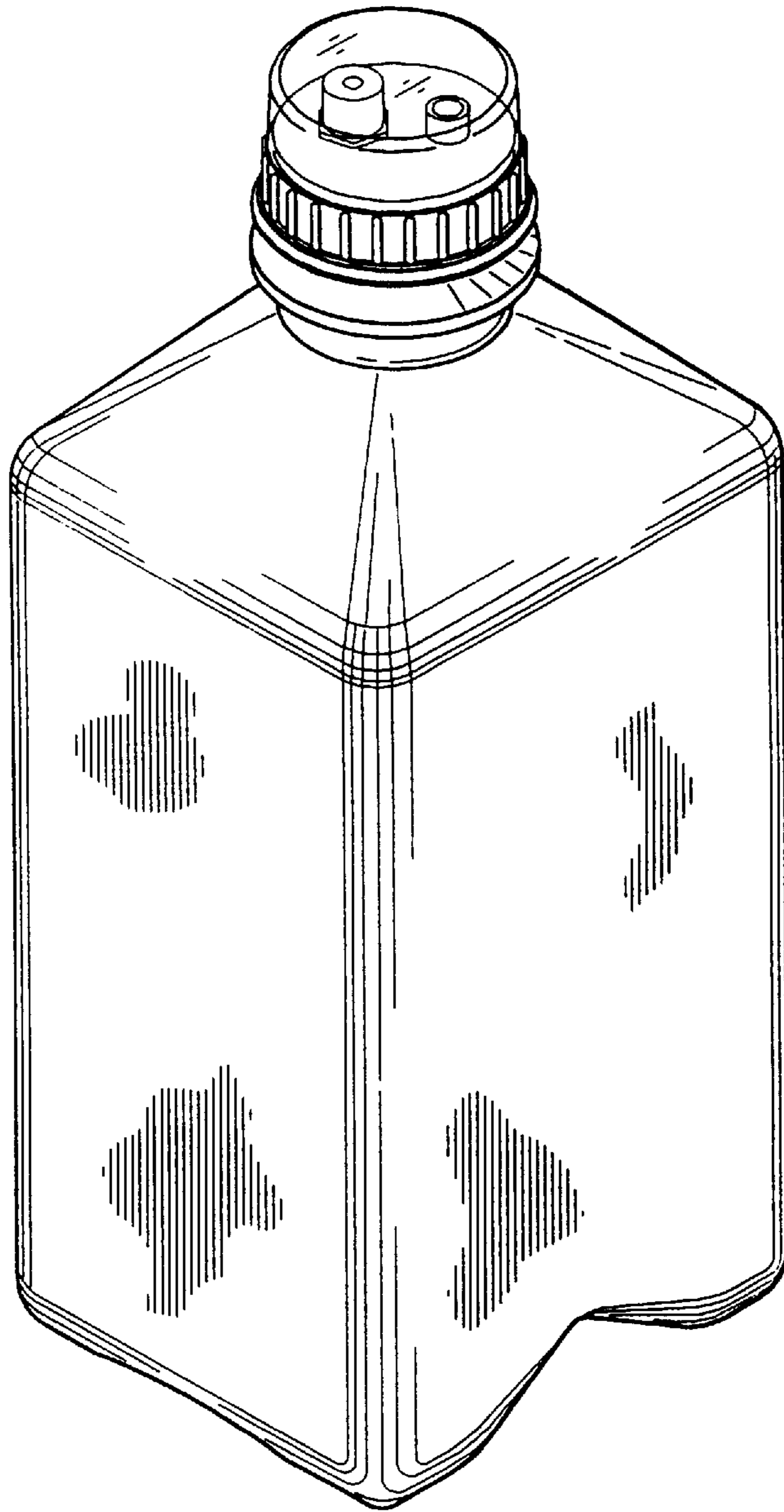

FIG. 10

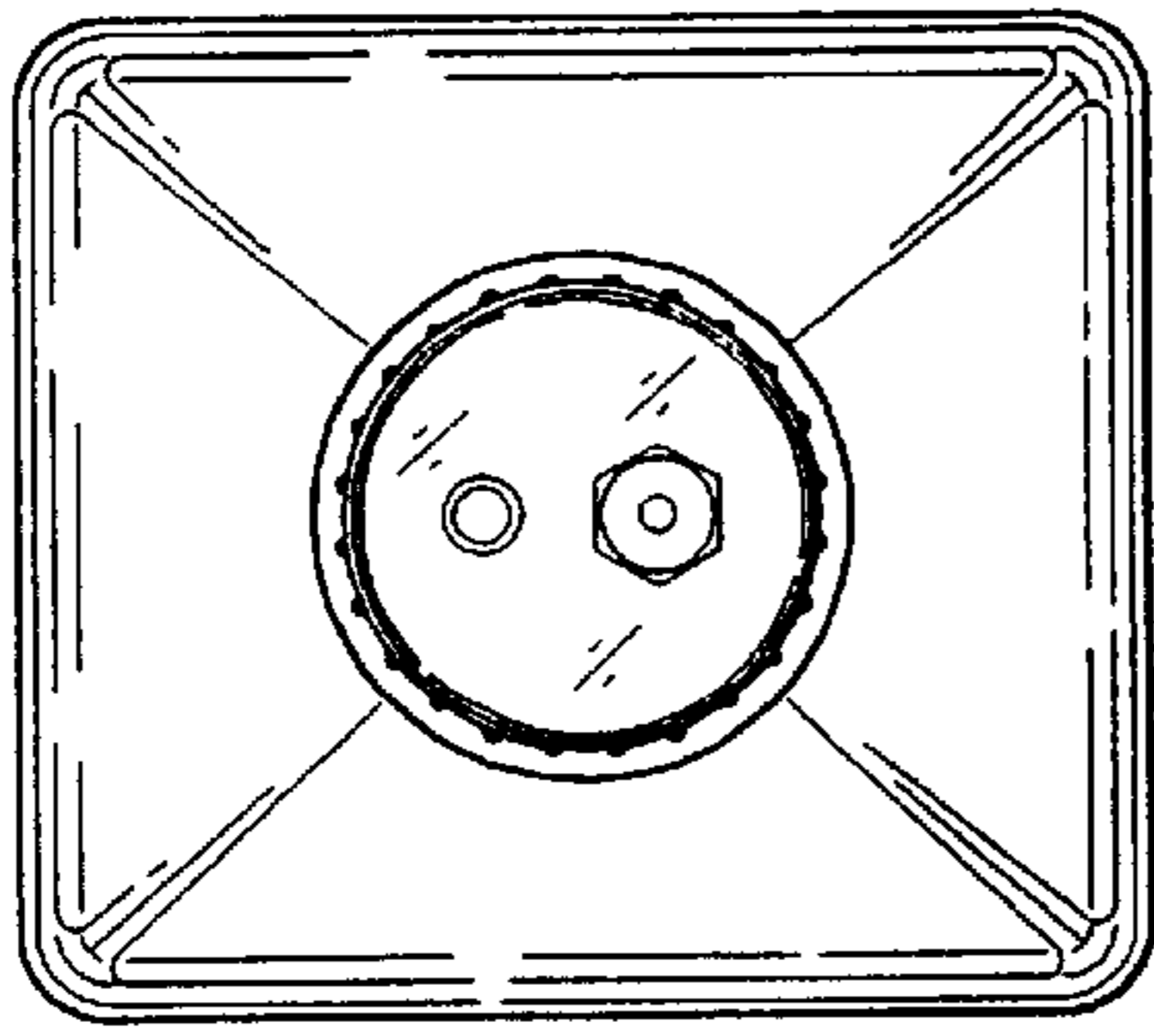

FIG. 13

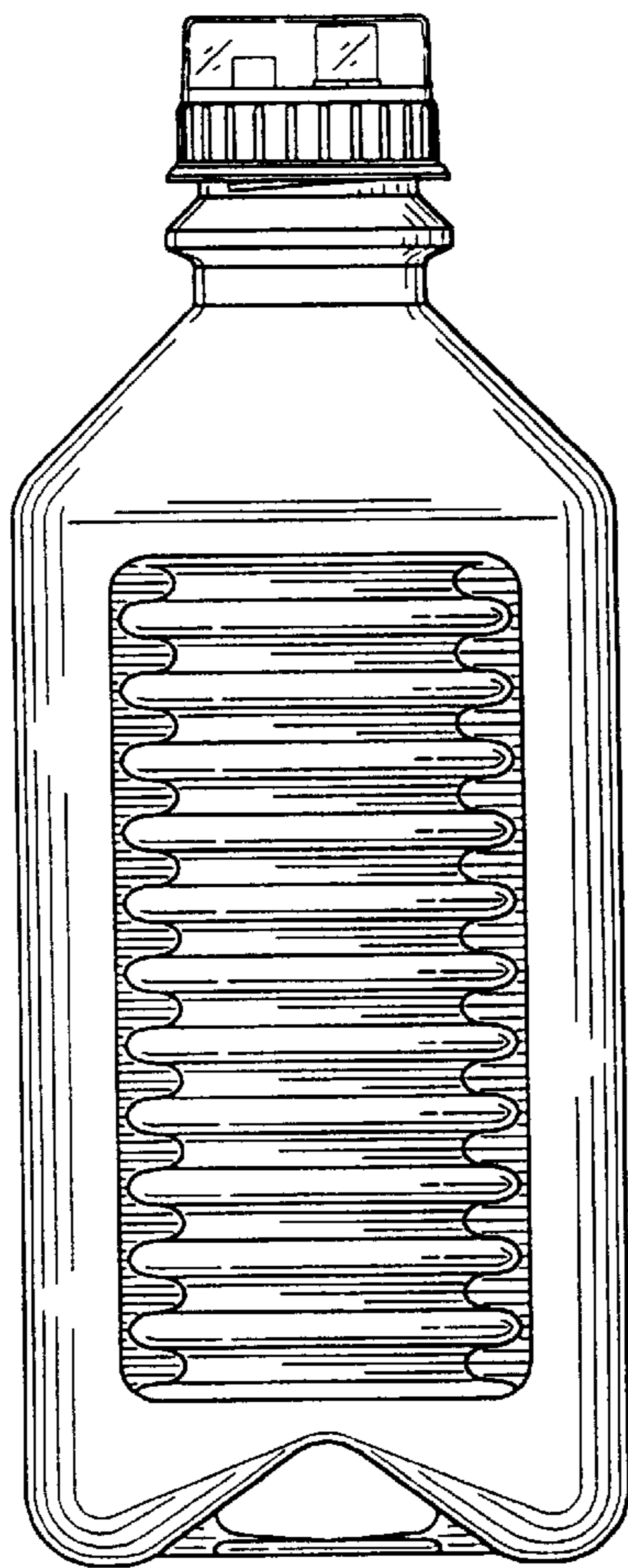

FIG. 11

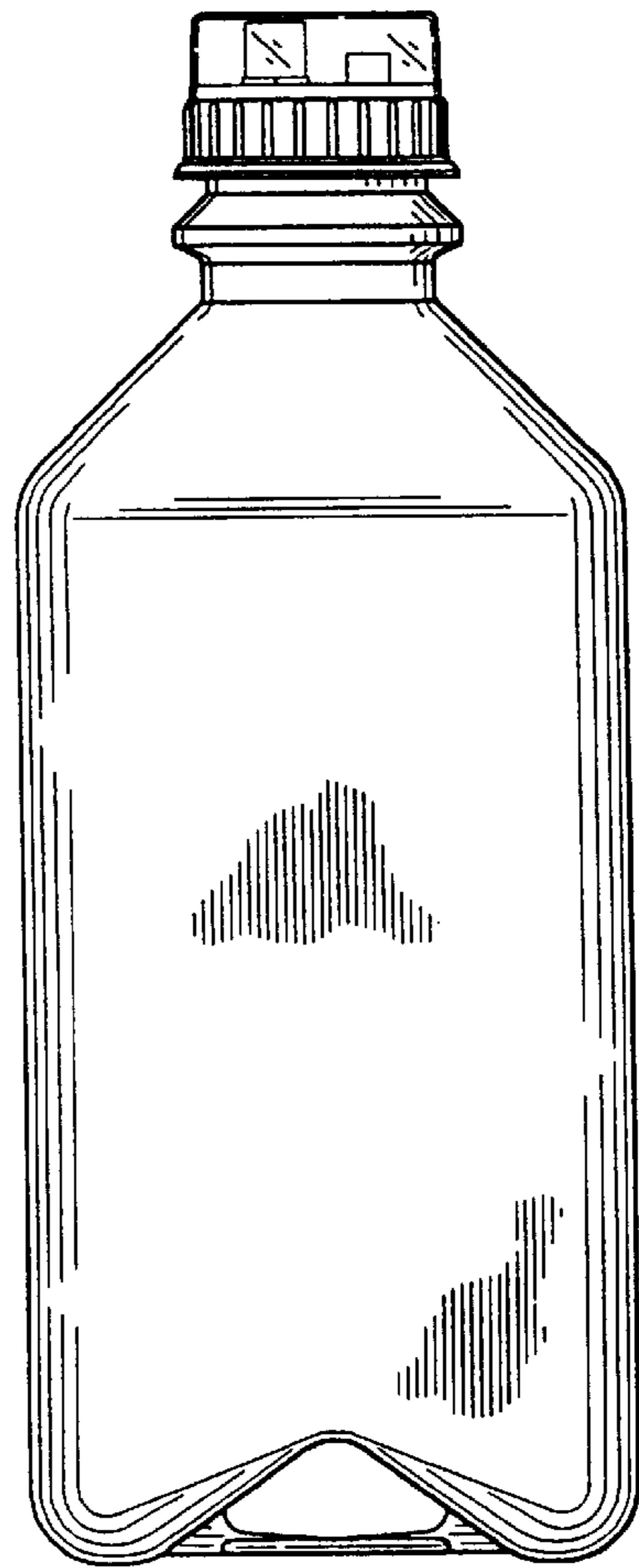

FIG. 12

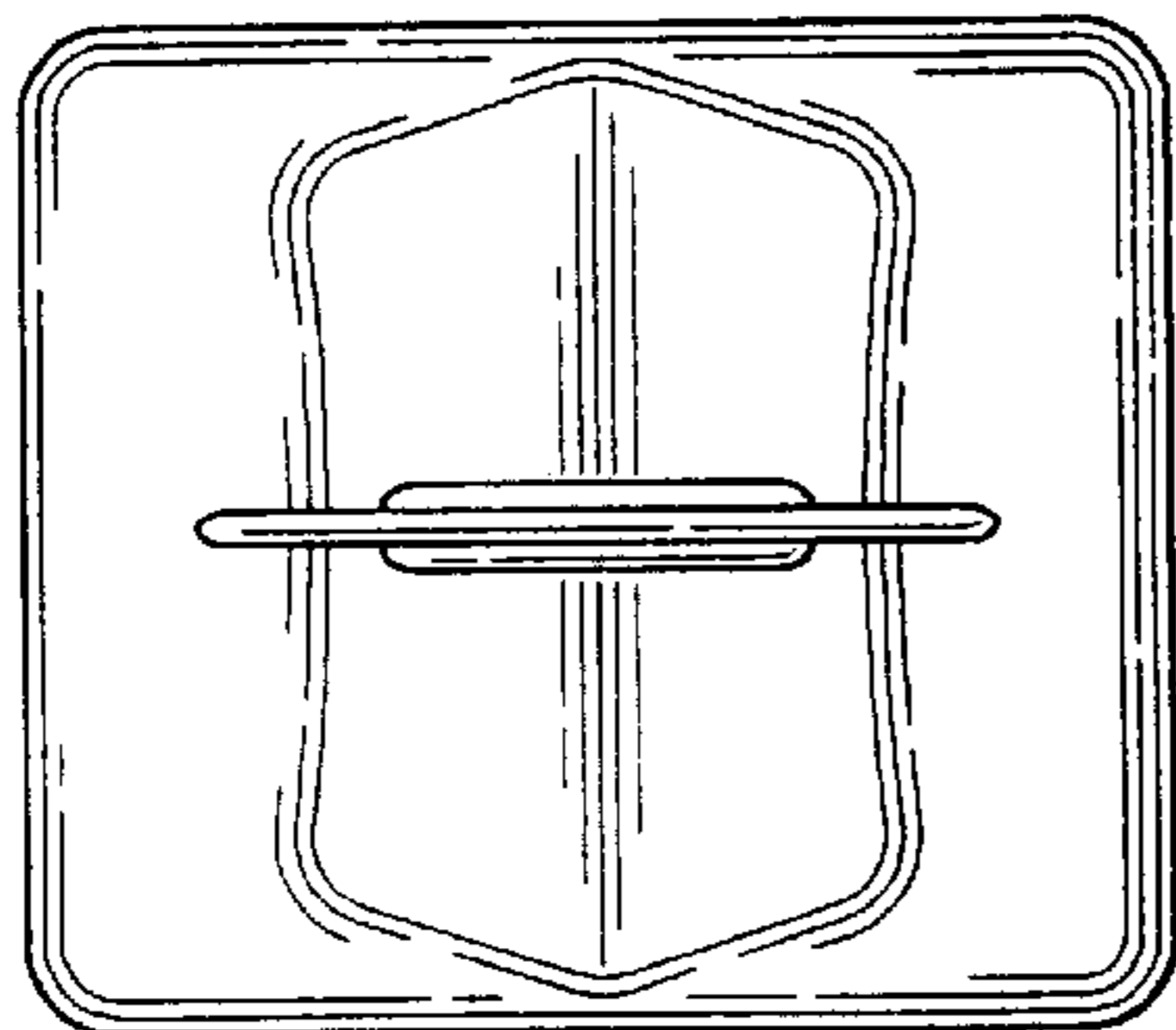

FIG. 14

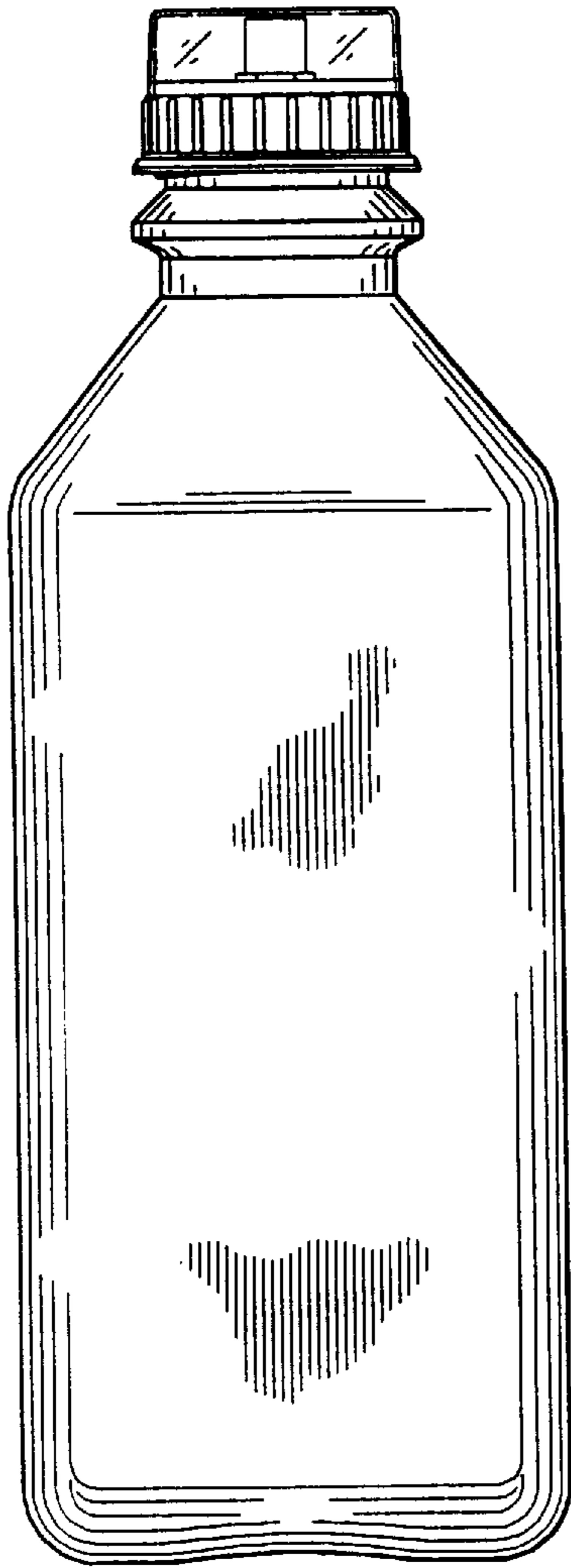

FIG. 15

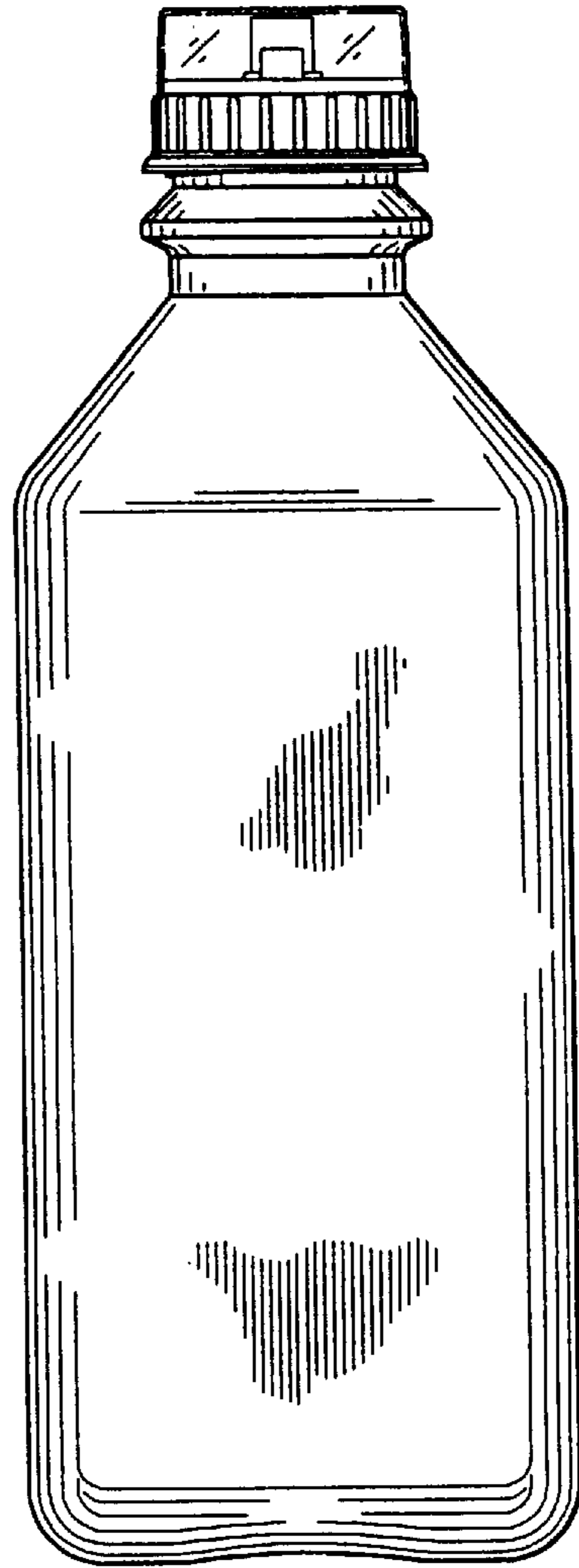

FIG. 16

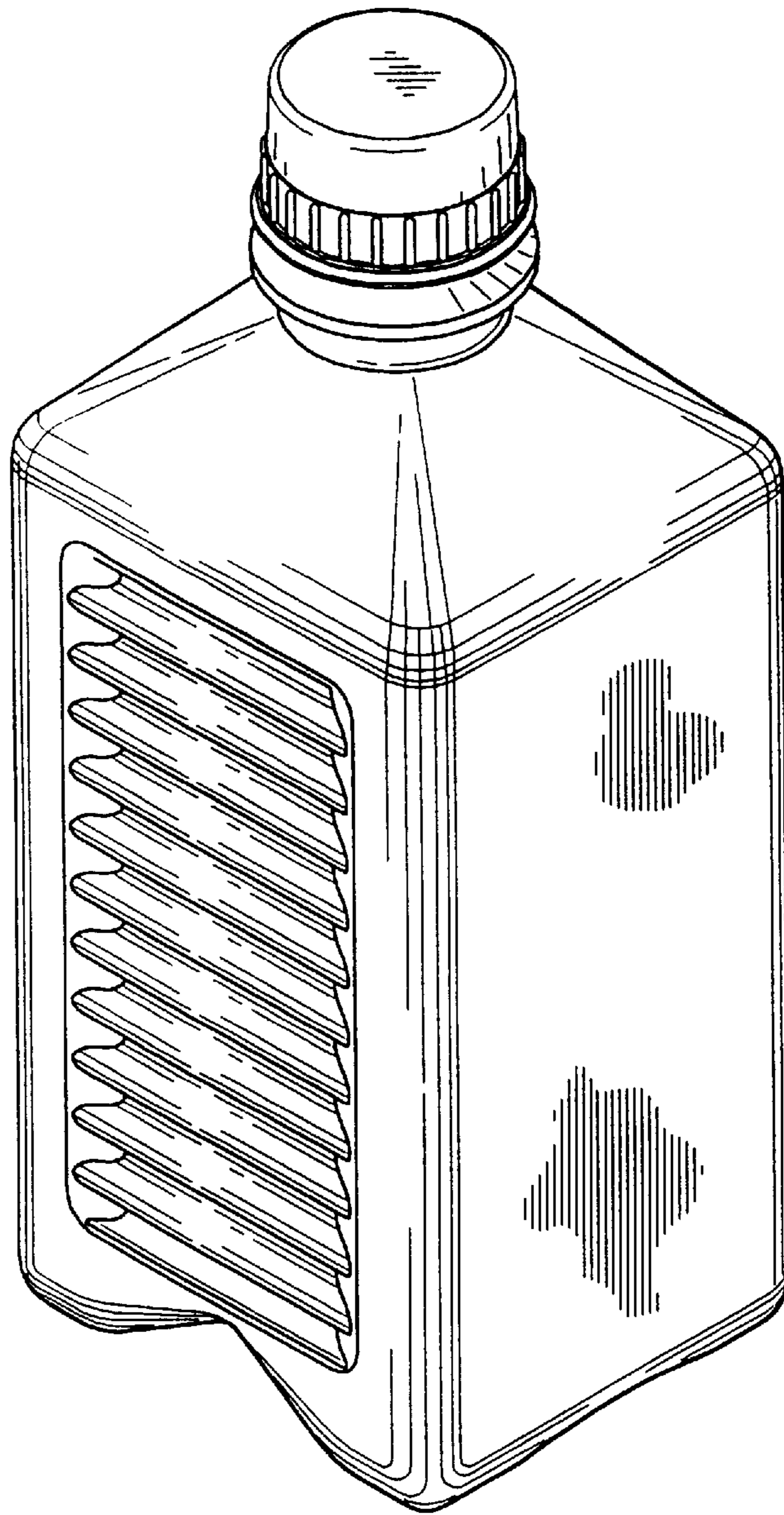

FIG. 17

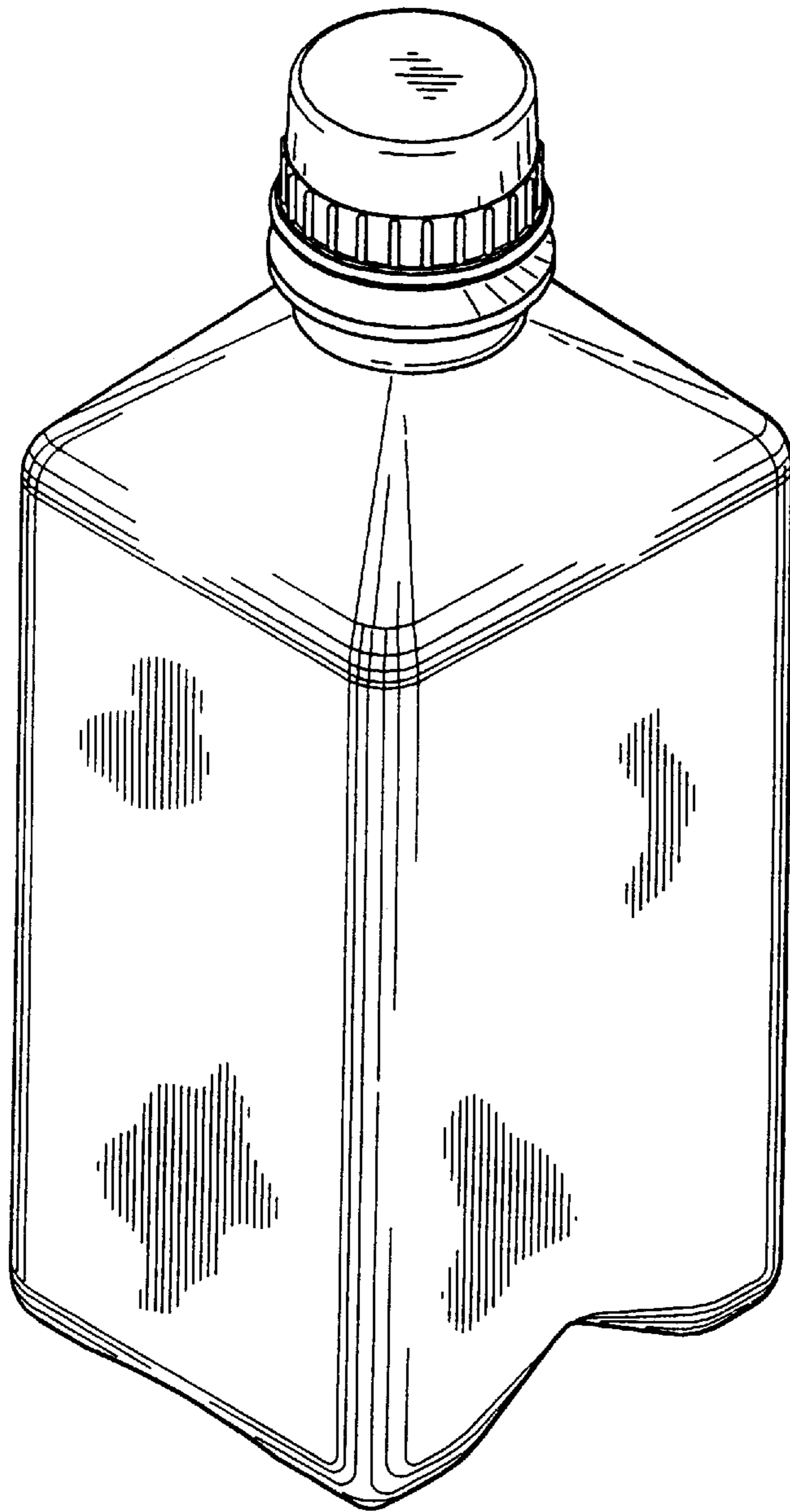

FIG. 18

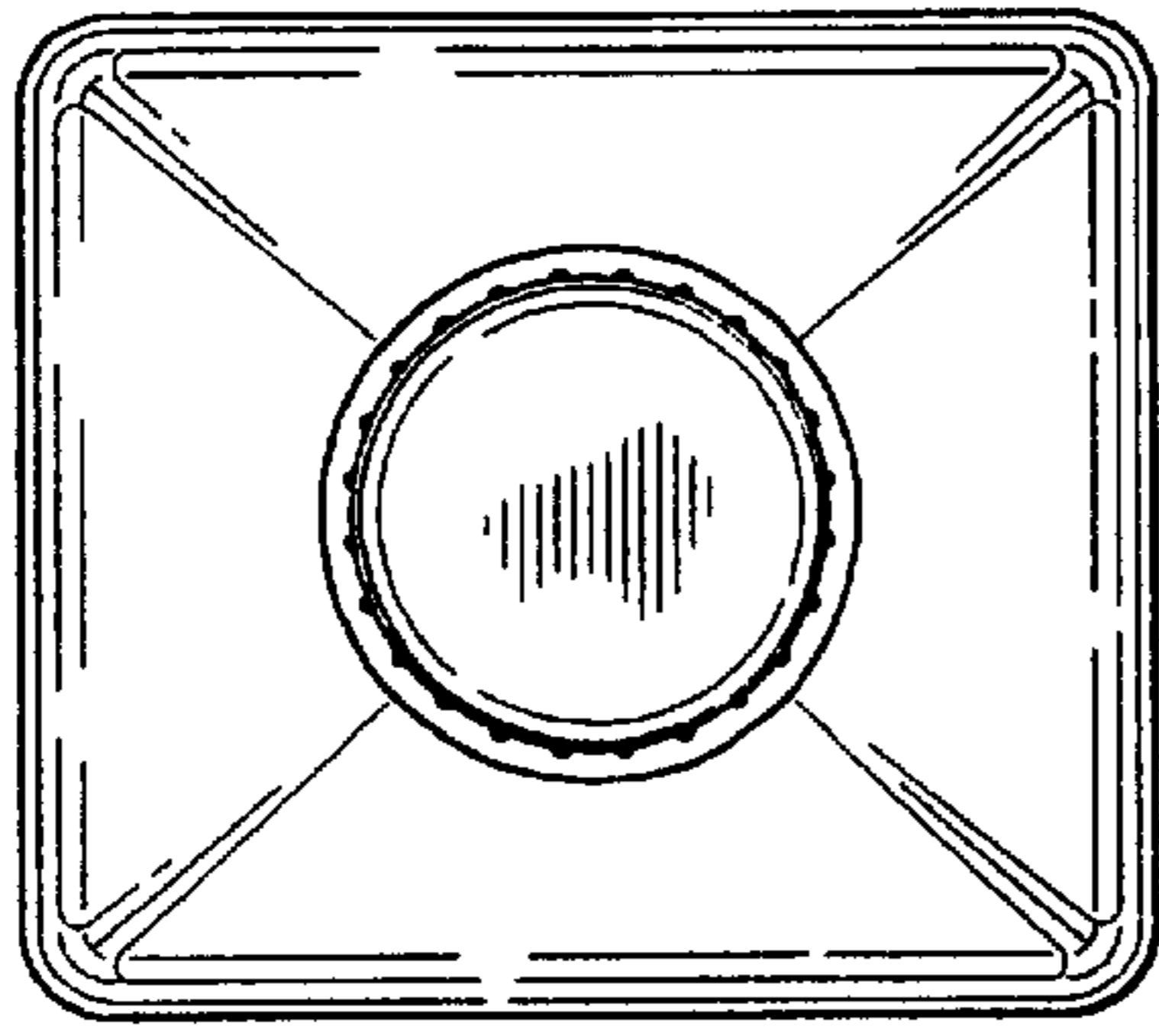

FIG. 21

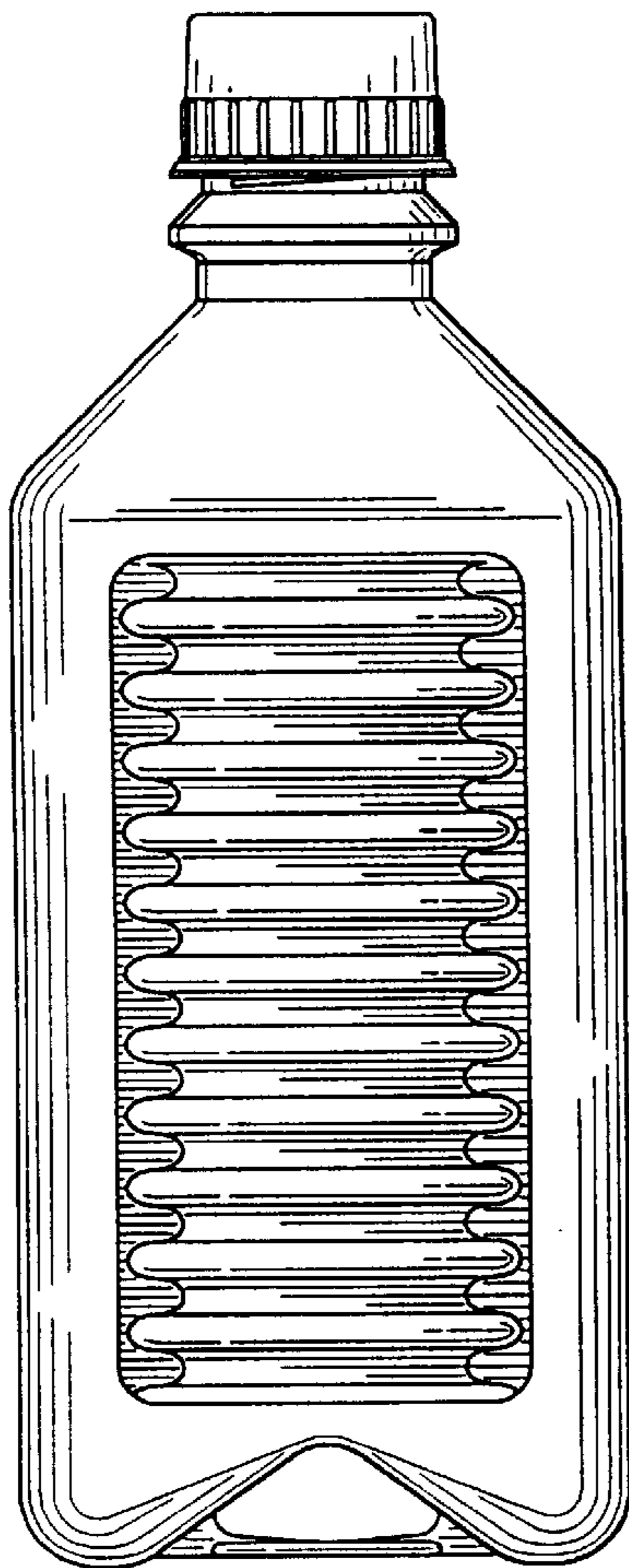

FIG. 19

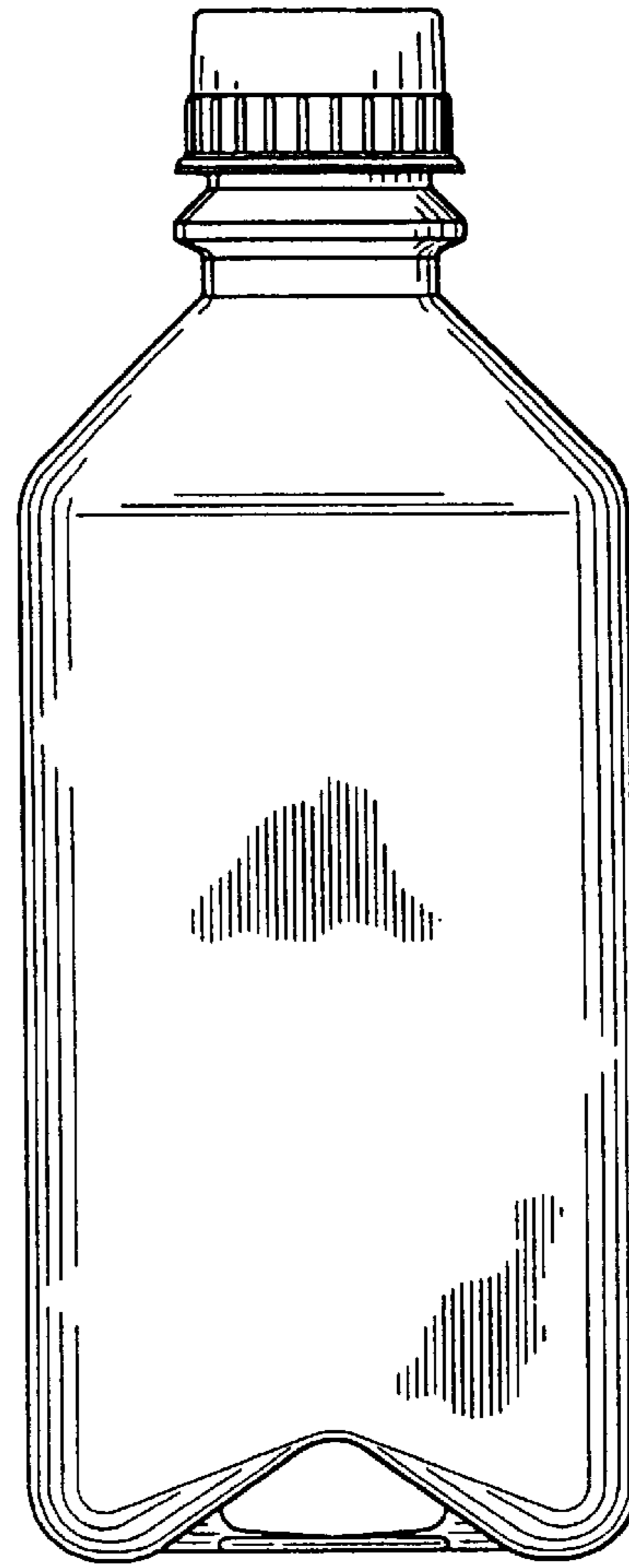

FIG. 20

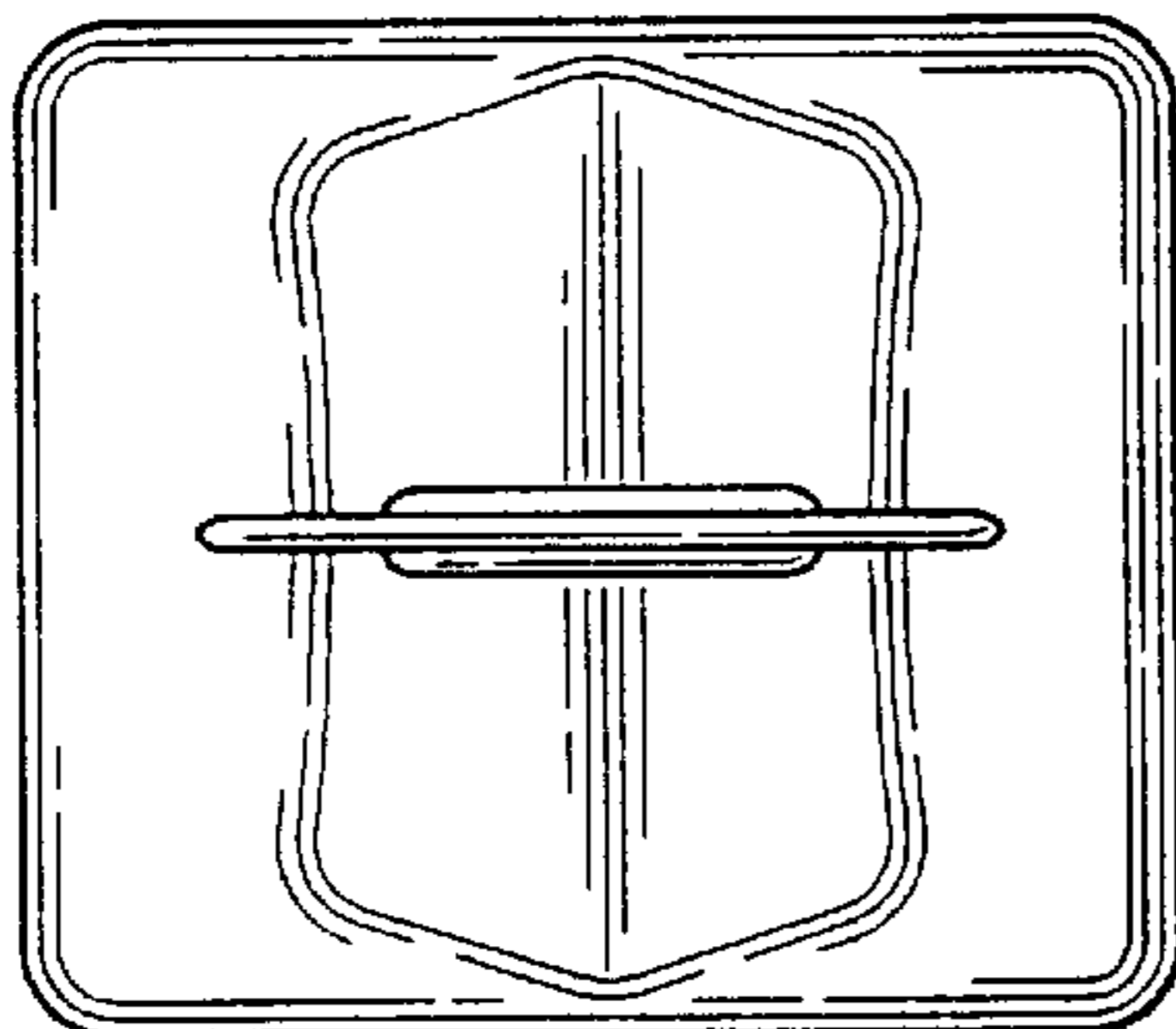

FIG. 22

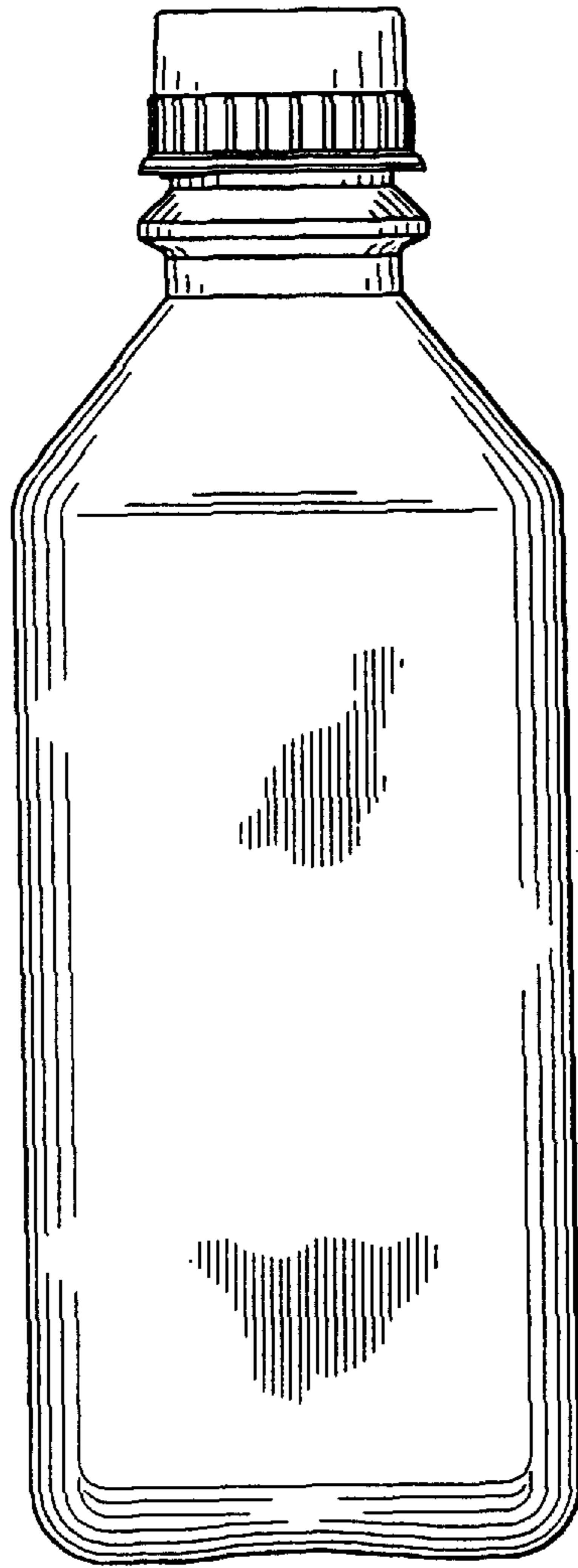

FIG. 23

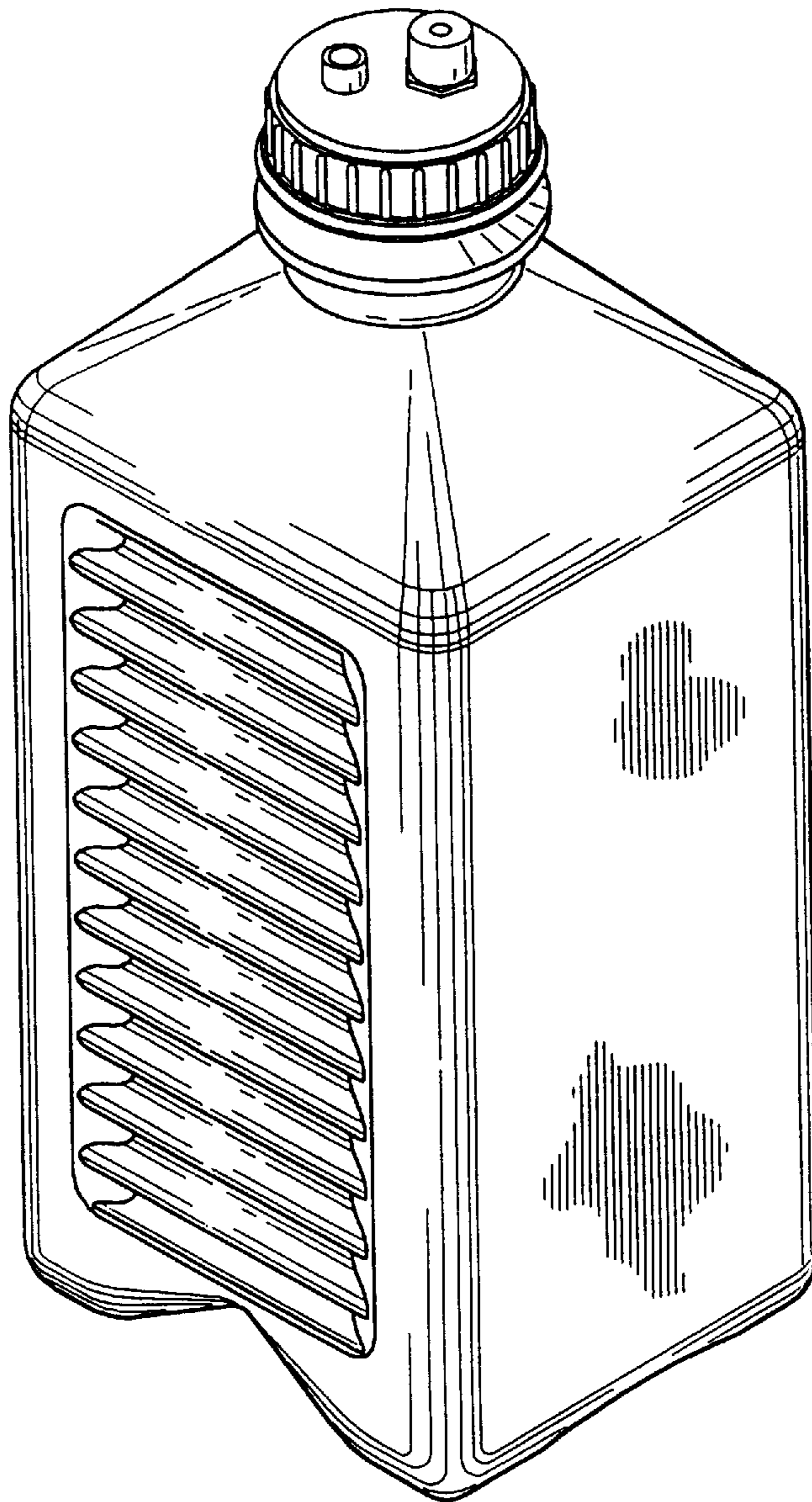

FIG. 24

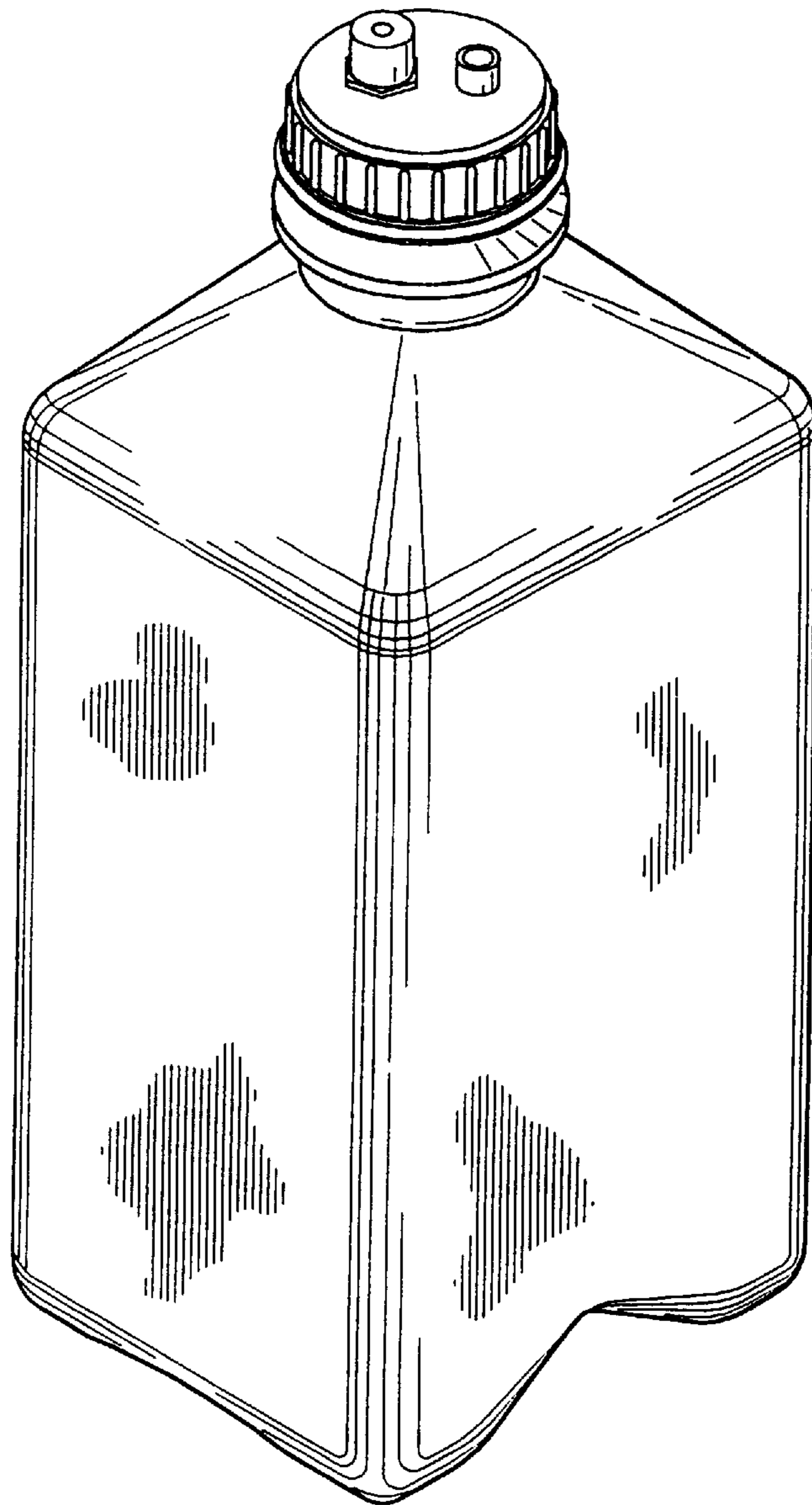

FIG. 25

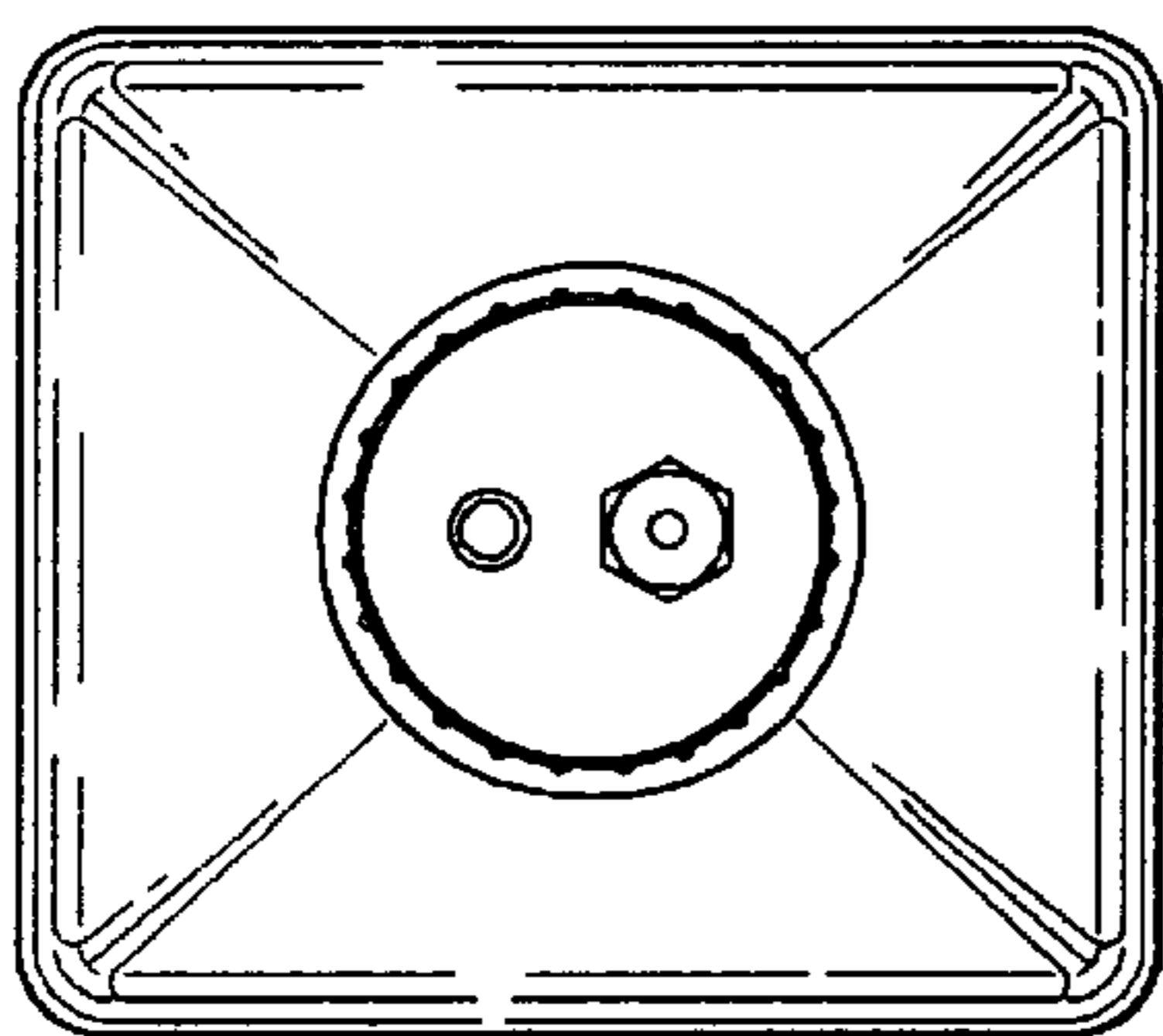

FIG. 28

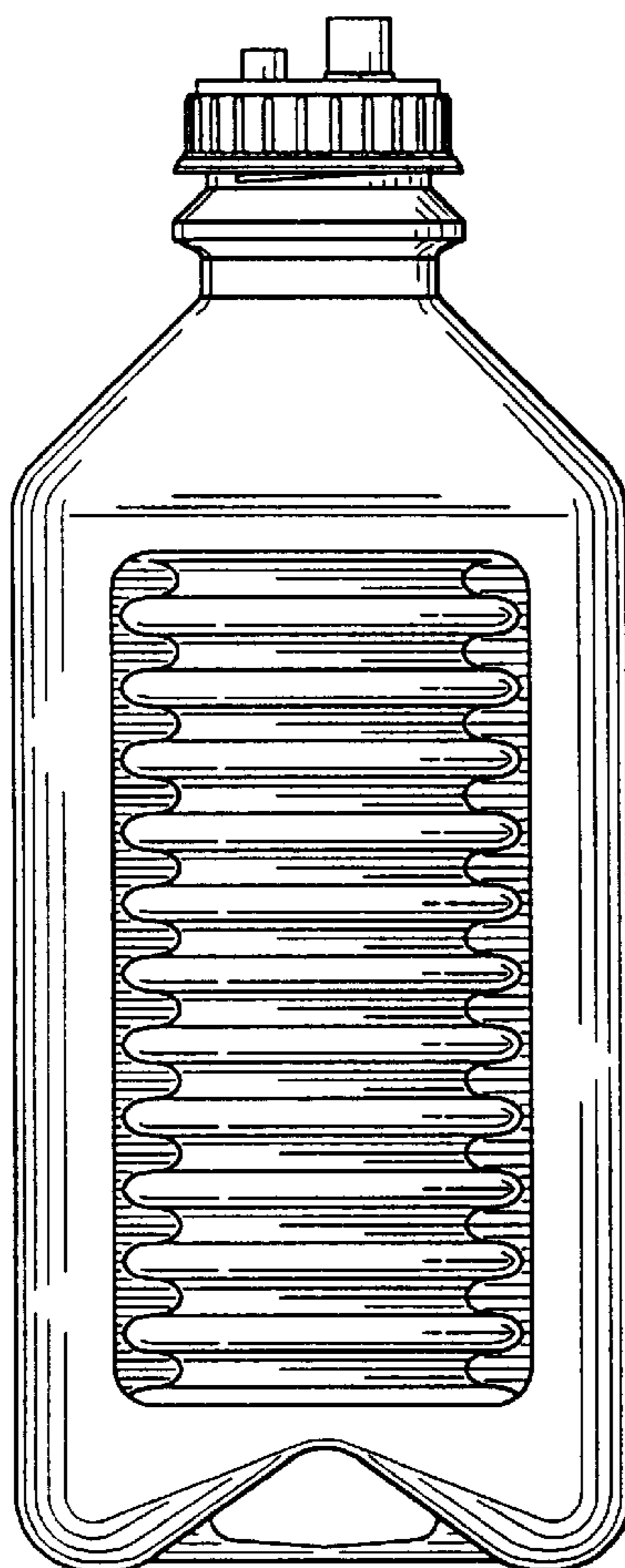

FIG. 26

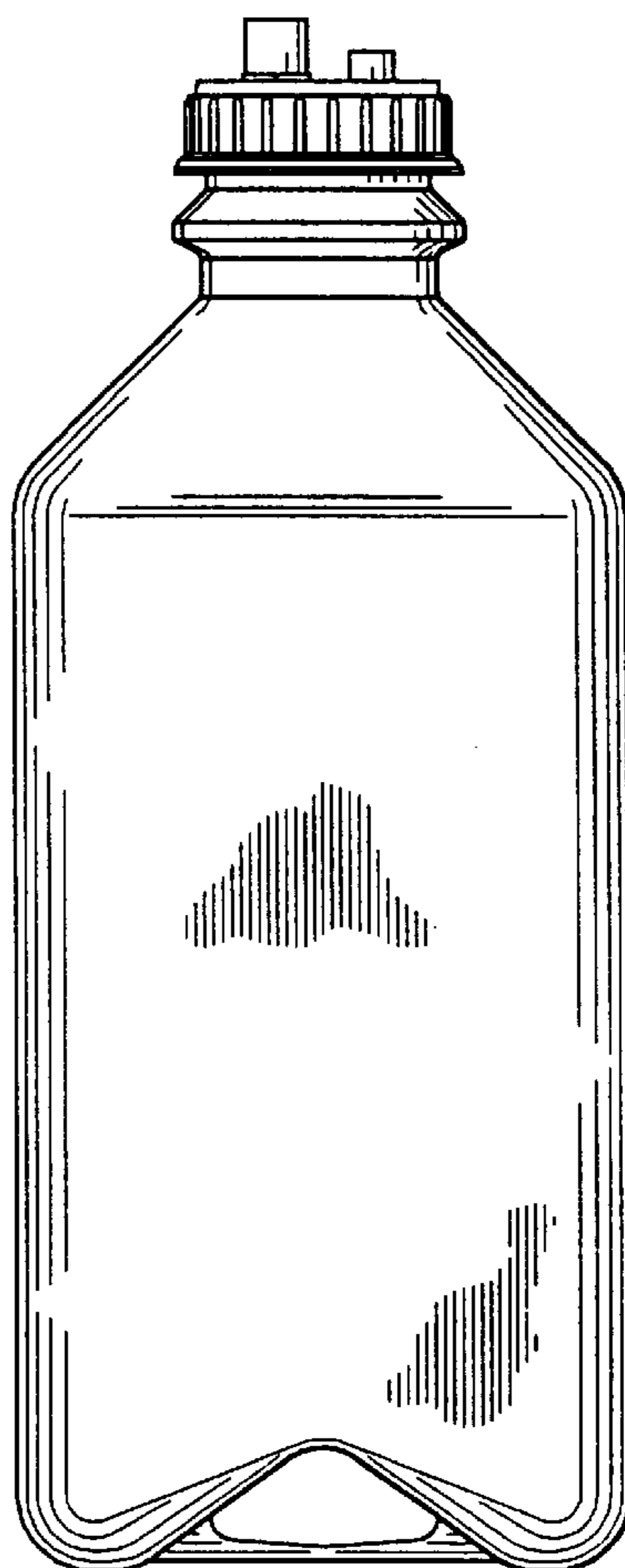

FIG. 27

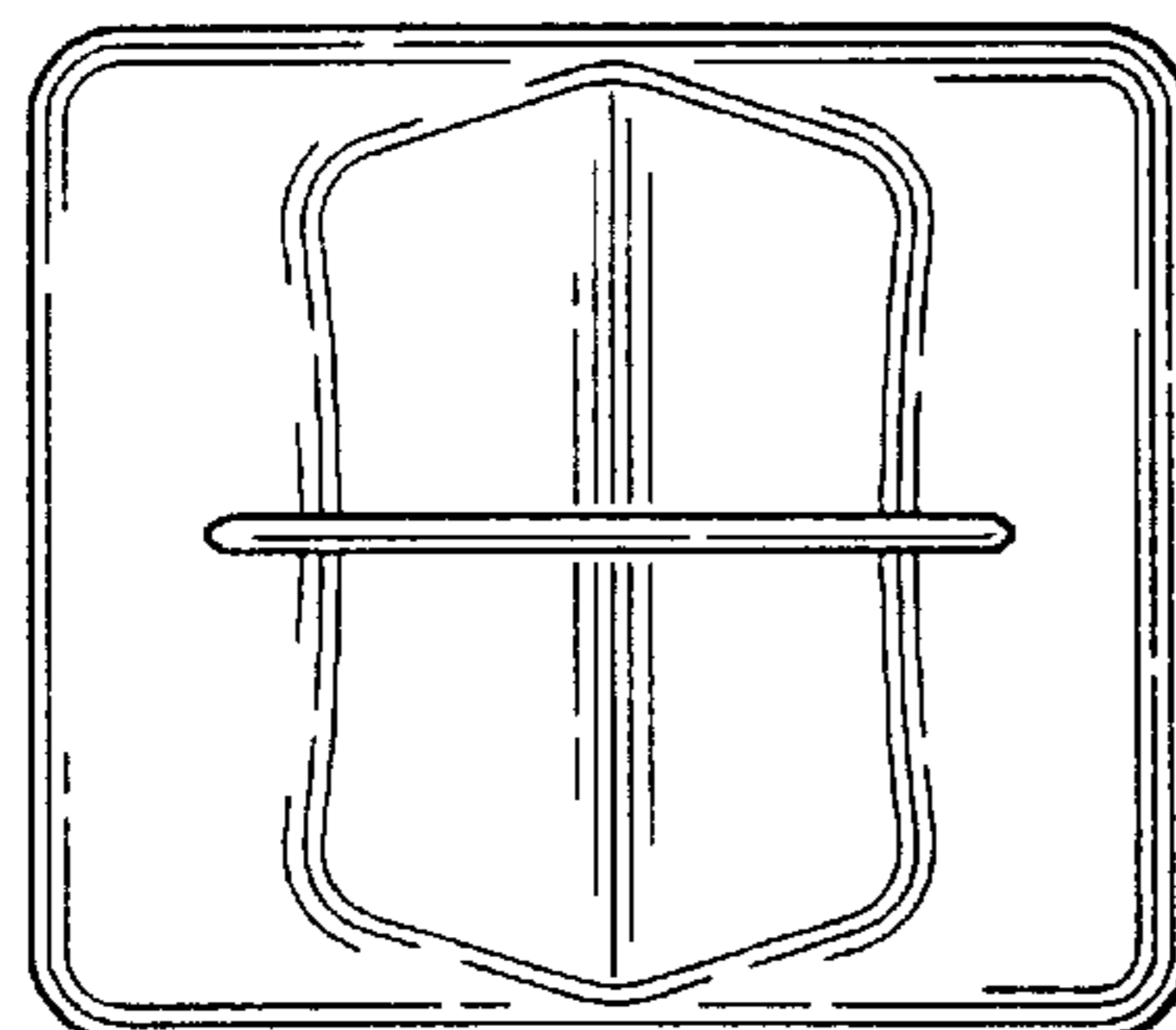

FIG. 29

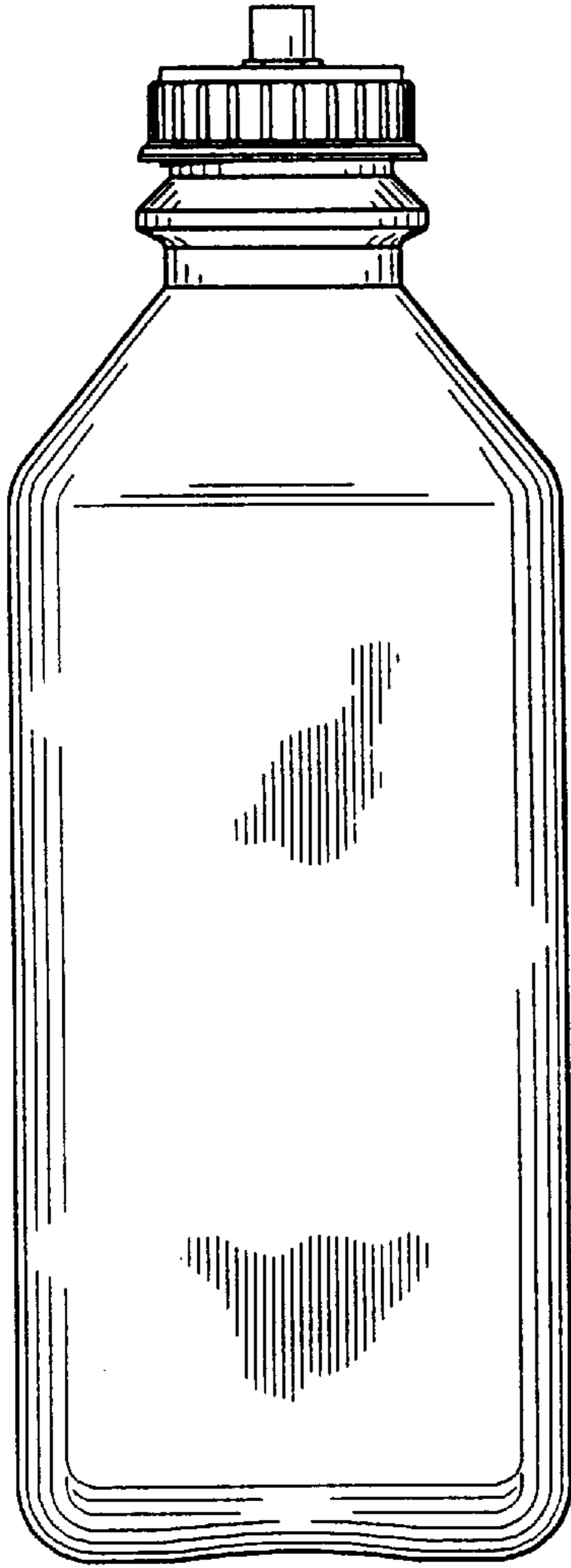

FIG. 30

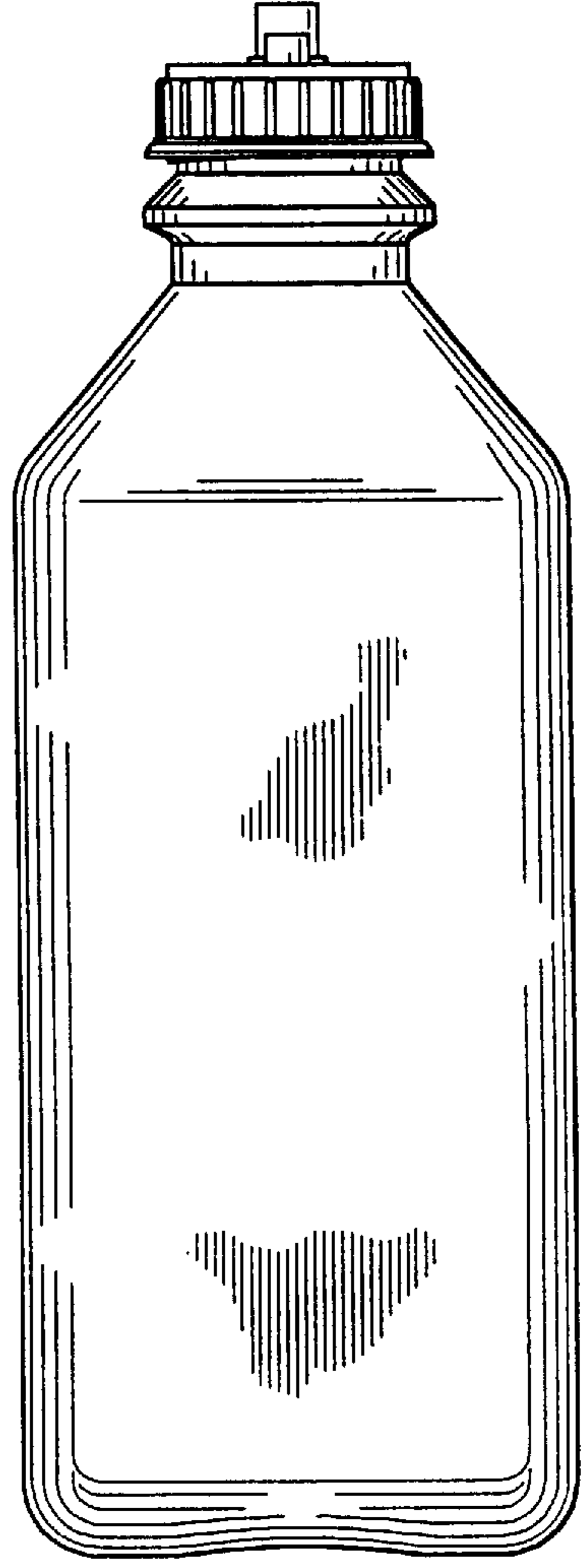

FIG. 31

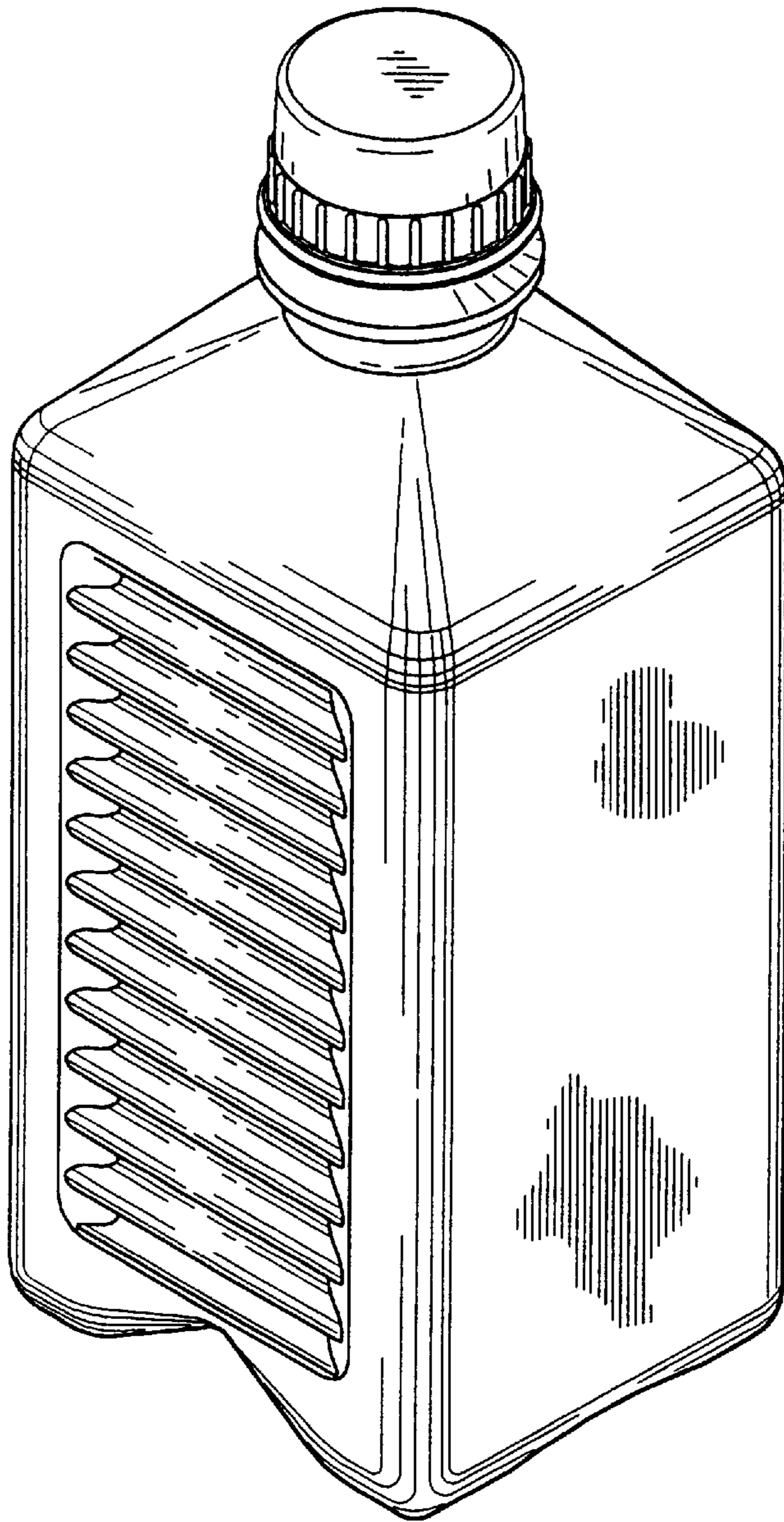

FIG. 32

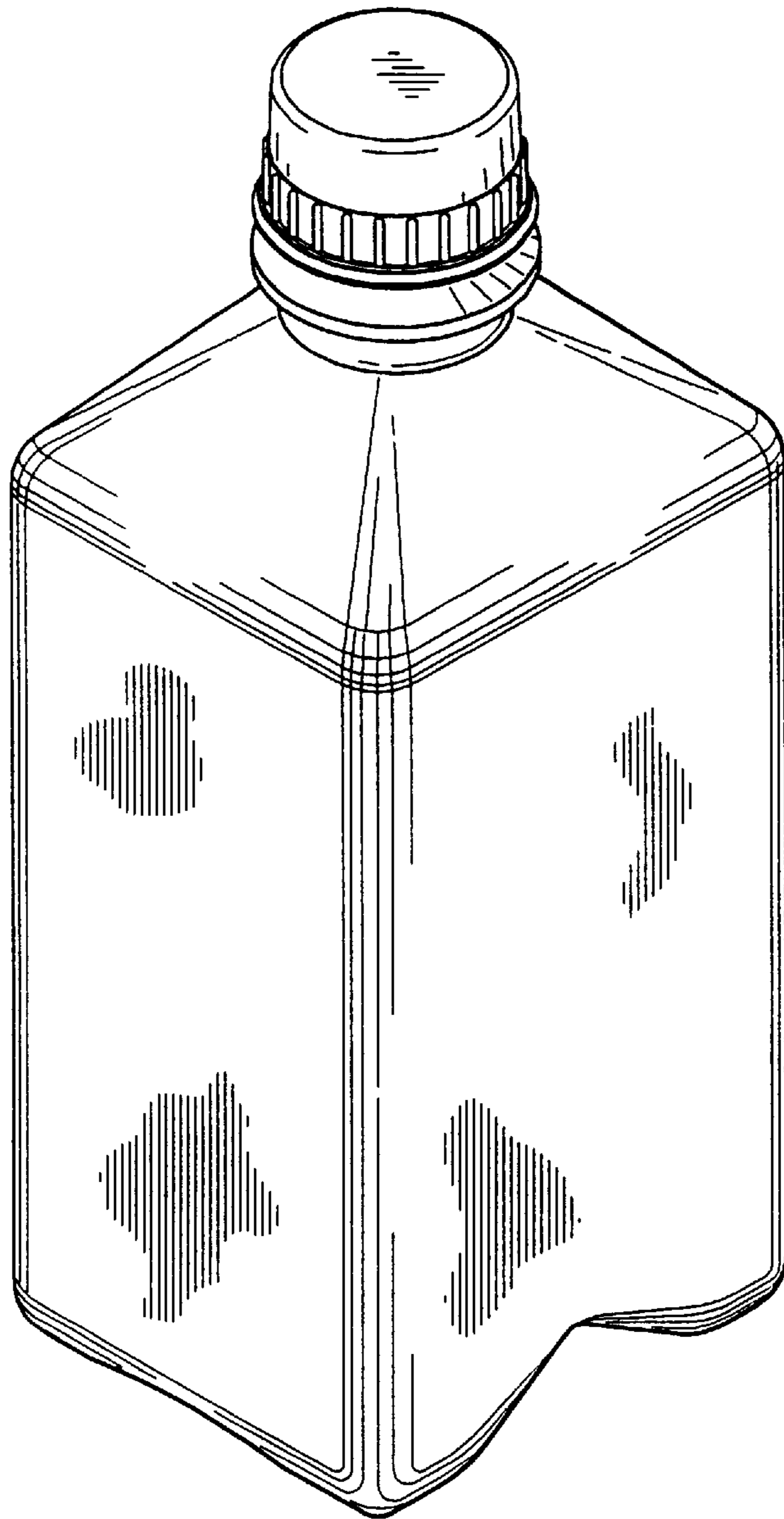

FIG. 33

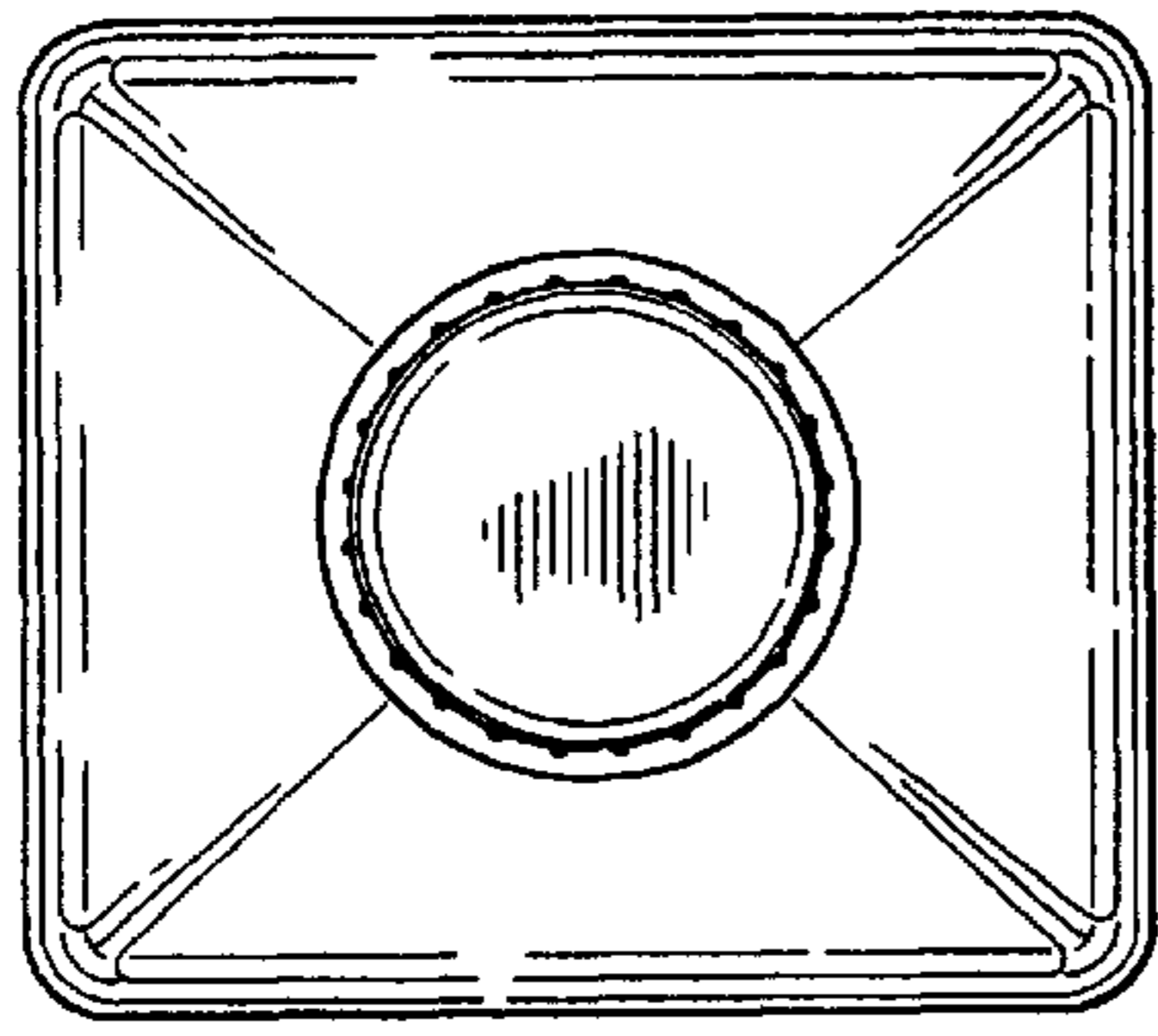

FIG. 36

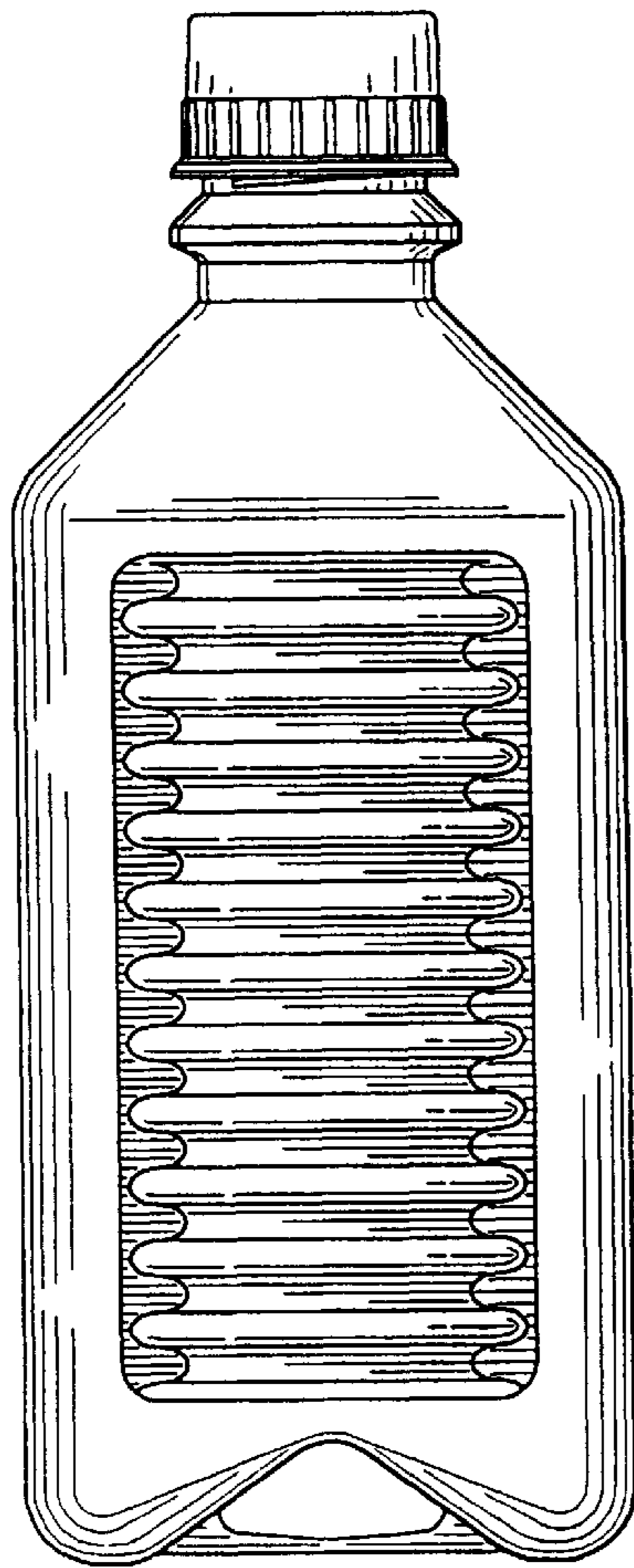

FIG. 34

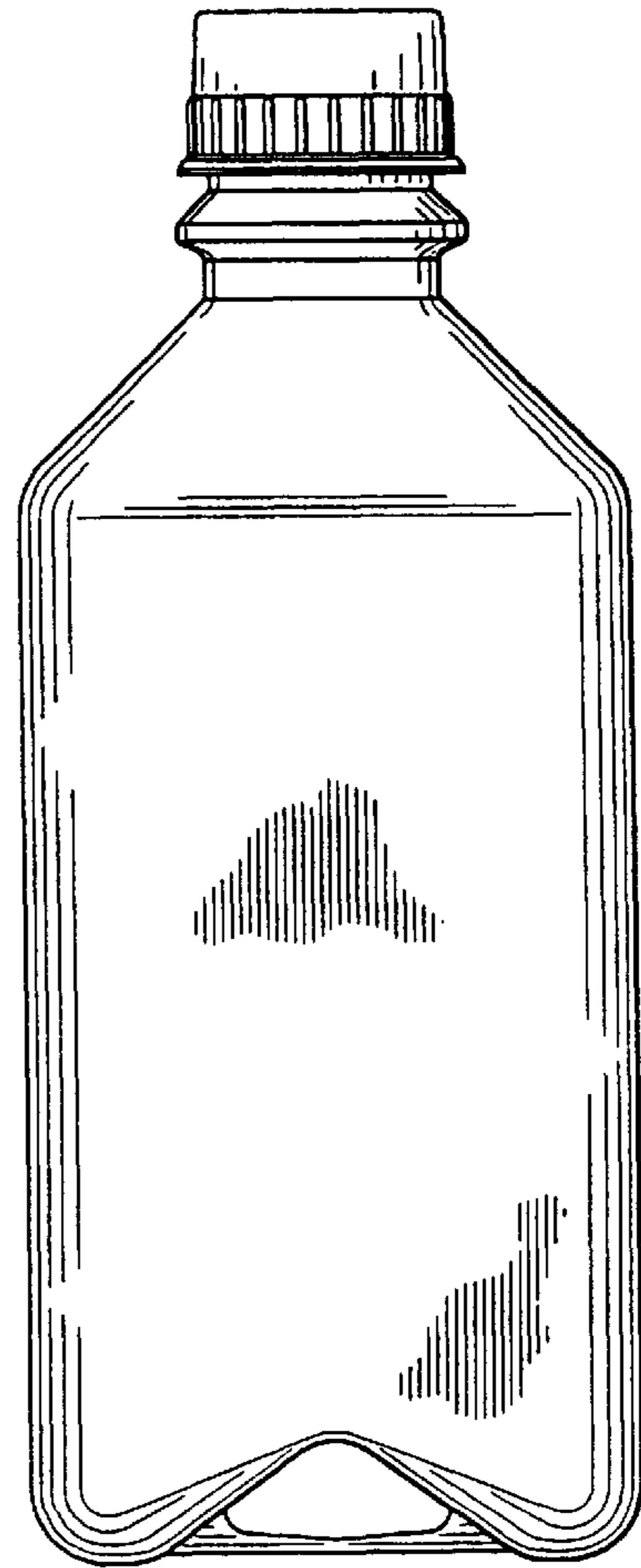

FIG. 35

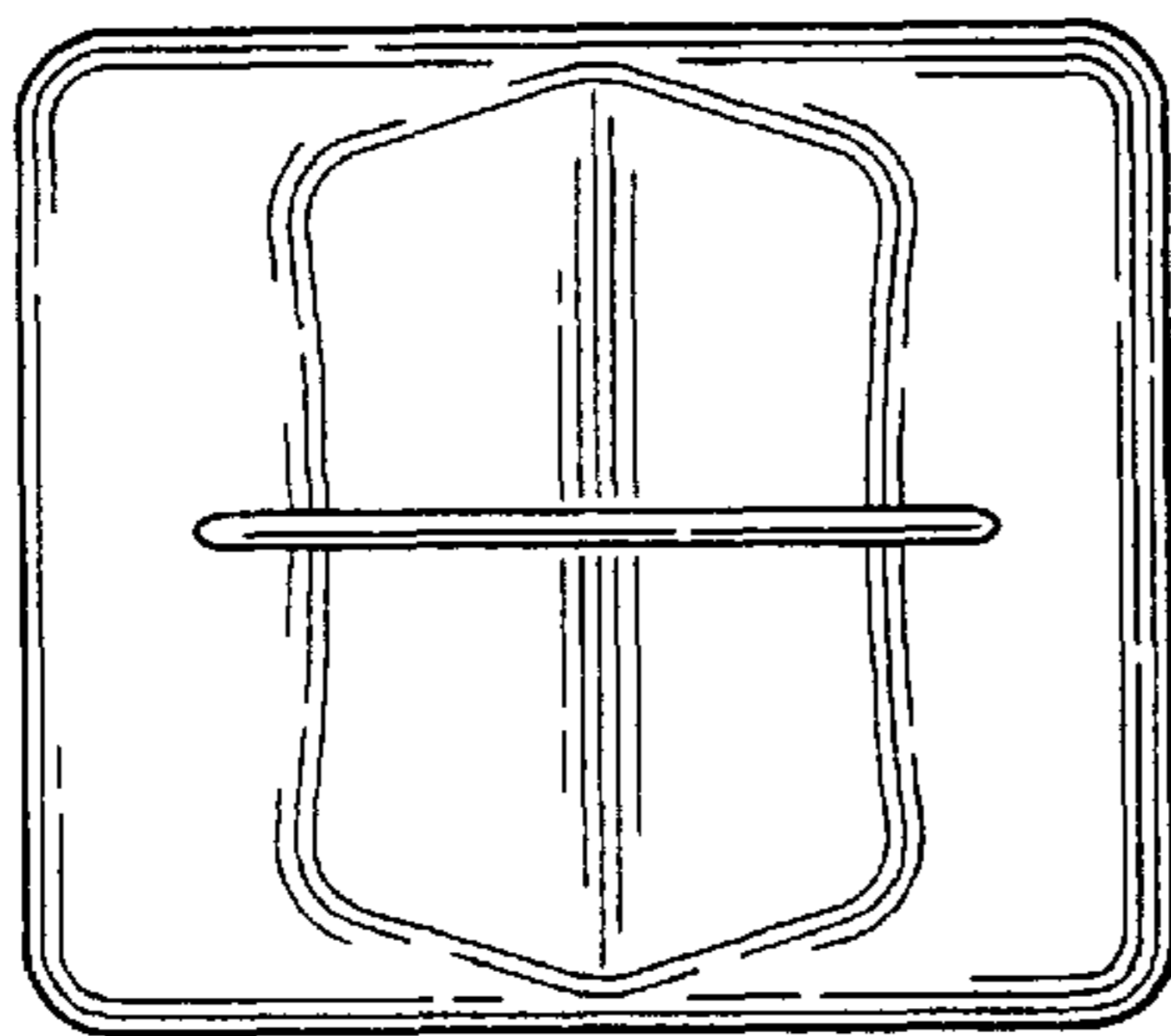

FIG. 37

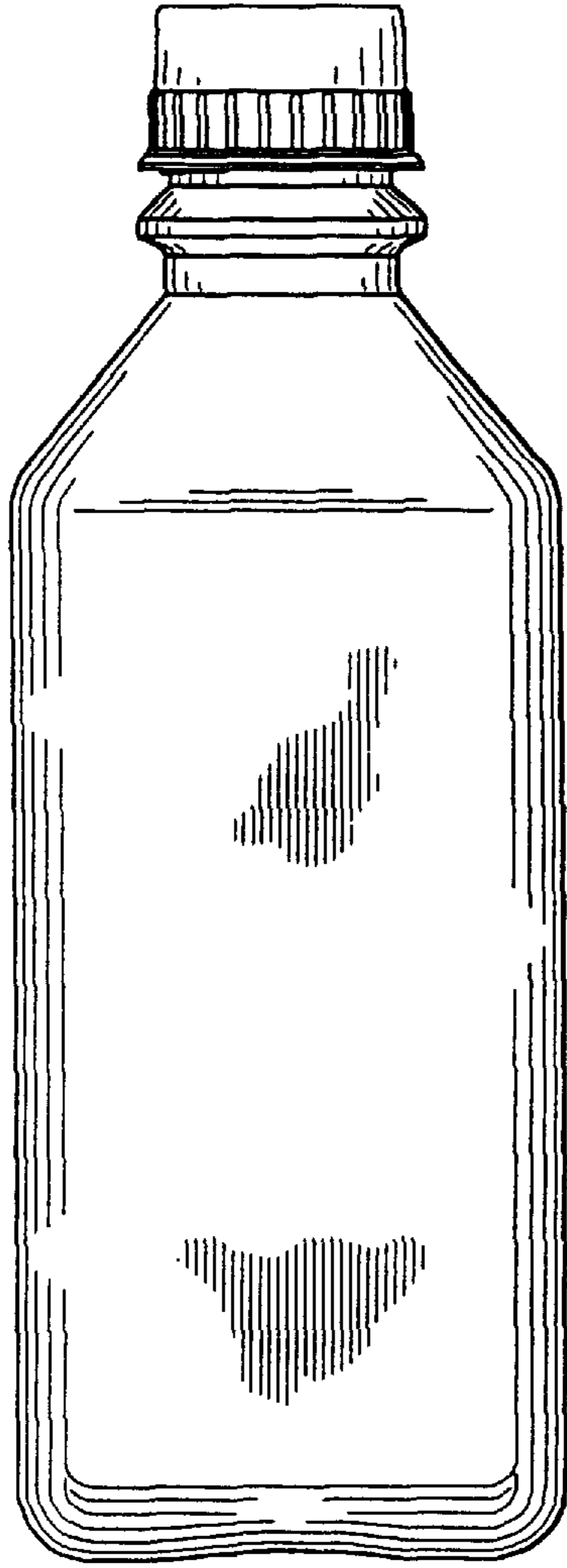

FIG. 38