



US00D407761S

United States Patent [19] Barr

[11] **Patent Number: Des. 407,761**
[45] **Date of Patent: **Apr. 6, 1999**

[54] **GAME MACHINE**

5,213,327 5/1993 Kitaue 463/46 X

[75] Inventor: **Lance Barr**, Carnation, Wash.

OTHER PUBLICATIONS

Nintendo 64/64 bit, Jun. 1996.

[73] Assignee: **Nintendo Co. Ltd.**, Japan

Primary Examiner—Prabhakar G. Deshmukh
Attorney, Agent, or Firm—Nixon & Vanderhye P.C.

[**] Term: **14 Years**

[21] Appl. No.: **82,994**

[57] CLAIM

The ornamental design for a “game machine”, as shown and described.

[22] Filed: **Feb. 3, 1998**

[30] Foreign Application Priority Data

Aug. 18, 1997 [JP] Japan 9-65026
Aug. 18, 1997 [JP] Japan 9-65027

DESCRIPTION

[51] **LOC (6) Cl.** **21-01**

[52] **U.S. Cl.** **D21/329**

[58] **Field of Search** D21/324, 329,
D21/330, 332; D14/124, 125; 273/148 B;
463/1, 30–35, 43–47

FIG. 1 is a top plan view of a game machine in accordance with my new design;
FIG. 2 is a front elevation view thereof;
FIG. 3 is a bottom plan view thereof;
FIG. 4 is a rear elevation view thereof;
FIG. 5 is a left side elevation view thereof;
FIG. 6 is a right side elevation view thereof;
FIG. 7 is a left front perspective view thereof;
FIG. 8 is a left rear perspective view thereof;
FIG. 9 is a top plan view of a game machine in accordance with a second embodiment of my new design; and
FIG. 10 is a front elevation view thereof;
FIG. 11 is a left side elevation view thereof;
FIG. 12 is a right side elevation view thereof;
FIG. 13 is a left front perspective view thereof; and,
FIG. 14 is a left rear perspective view thereof; the bottom plan and rear elevation views being identical to FIGS. 3 and 4, respectively.

[56] References Cited

U.S. PATENT DOCUMENTS

D. 264,356 5/1982 Nagel D21/329
D. 299,726 2/1989 Yukawa .
D. 324,548 3/1992 Ashida .
D. 332,948 2/1993 Barr .
D. 333,686 3/1993 Barr et al. .
D. 350,992 9/1994 Barr .
D. 369,352 4/1996 Iwakami D21/332 X
D. 382,914 8/1997 Ho et al. D21/331
5,178,389 1/1993 Beatley et al. 463/31 X
5,212,368 5/1993 Hara 463/46 X

1 Claim, 9 Drawing Sheets

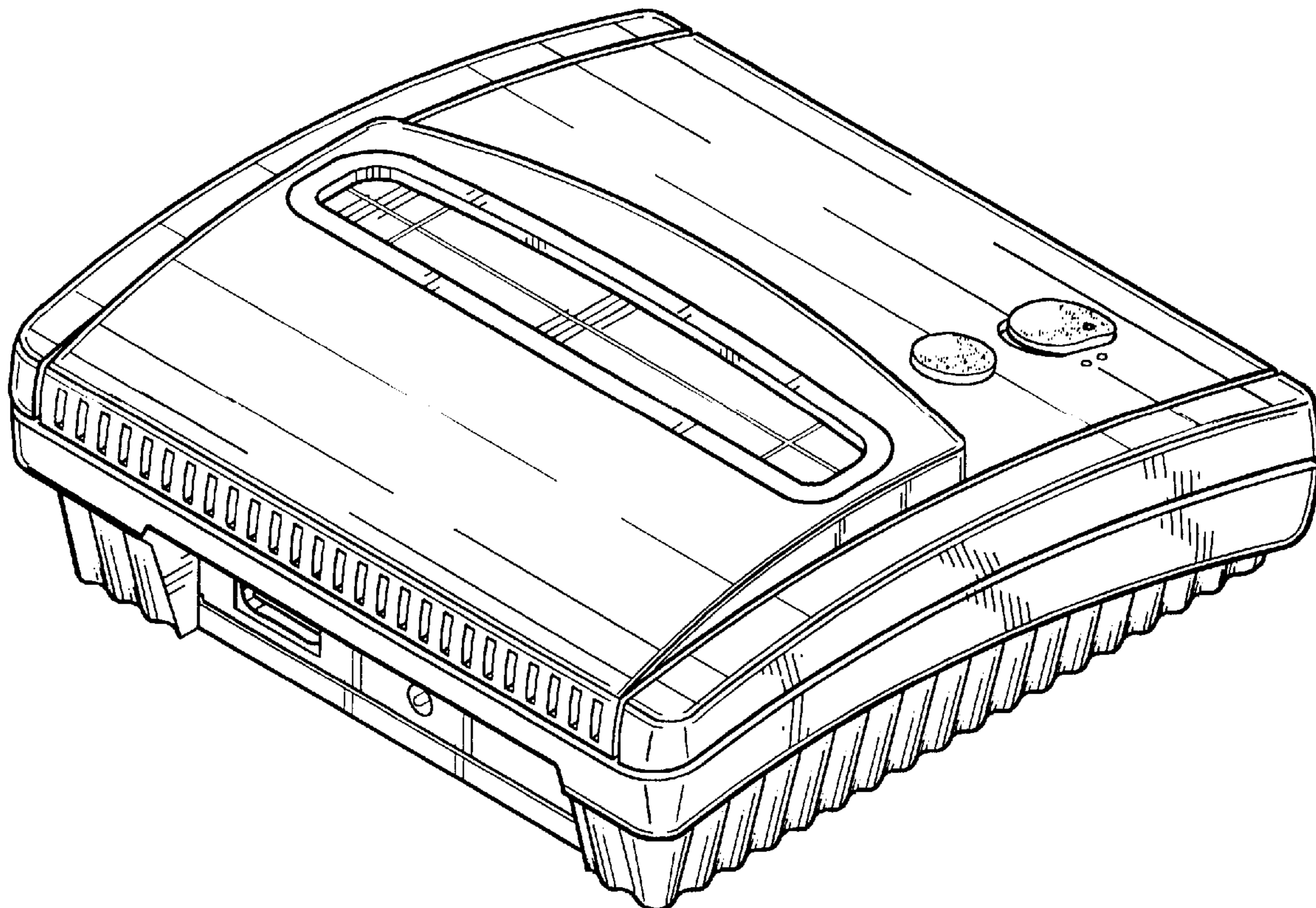

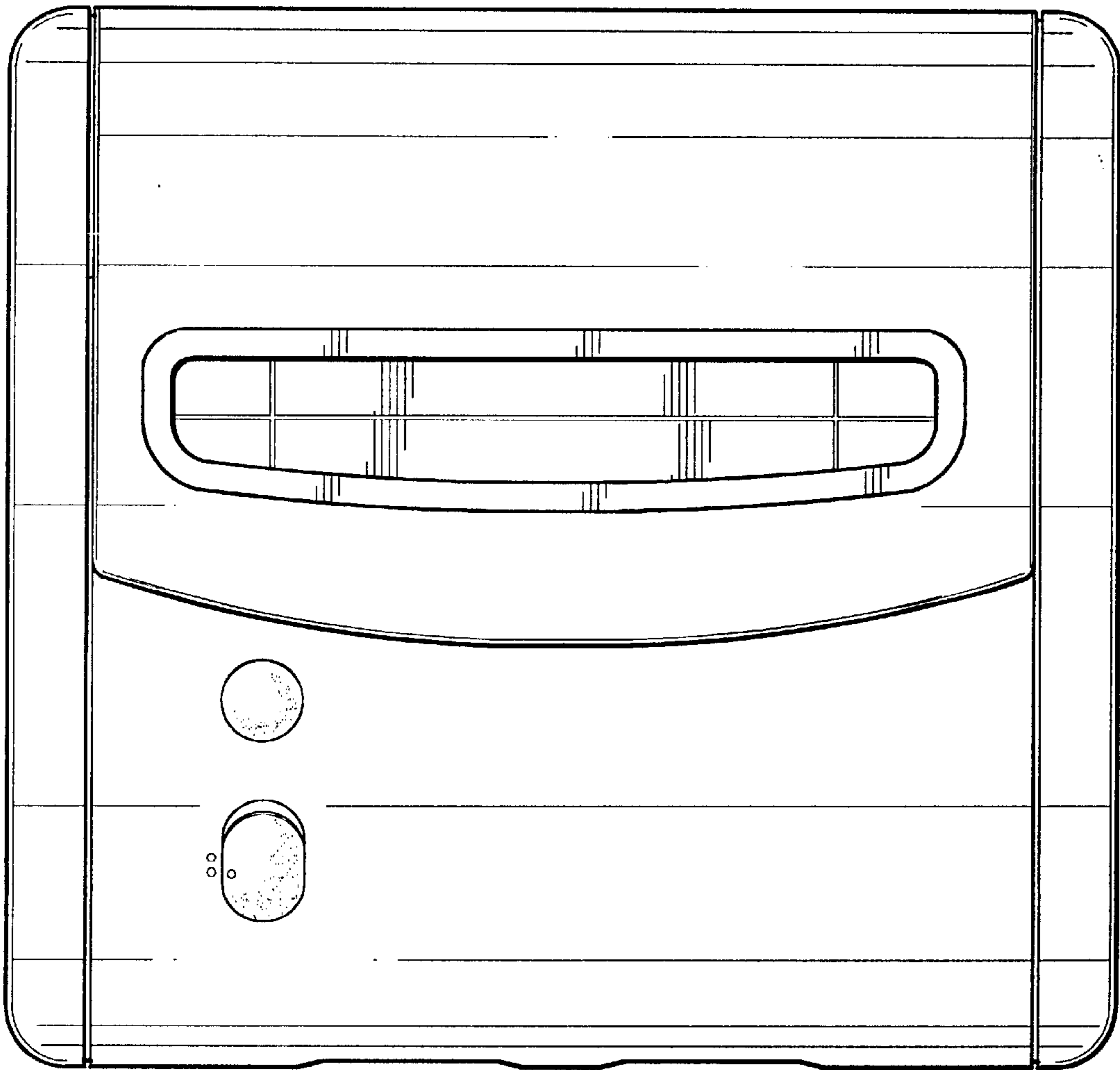

Fig. 1

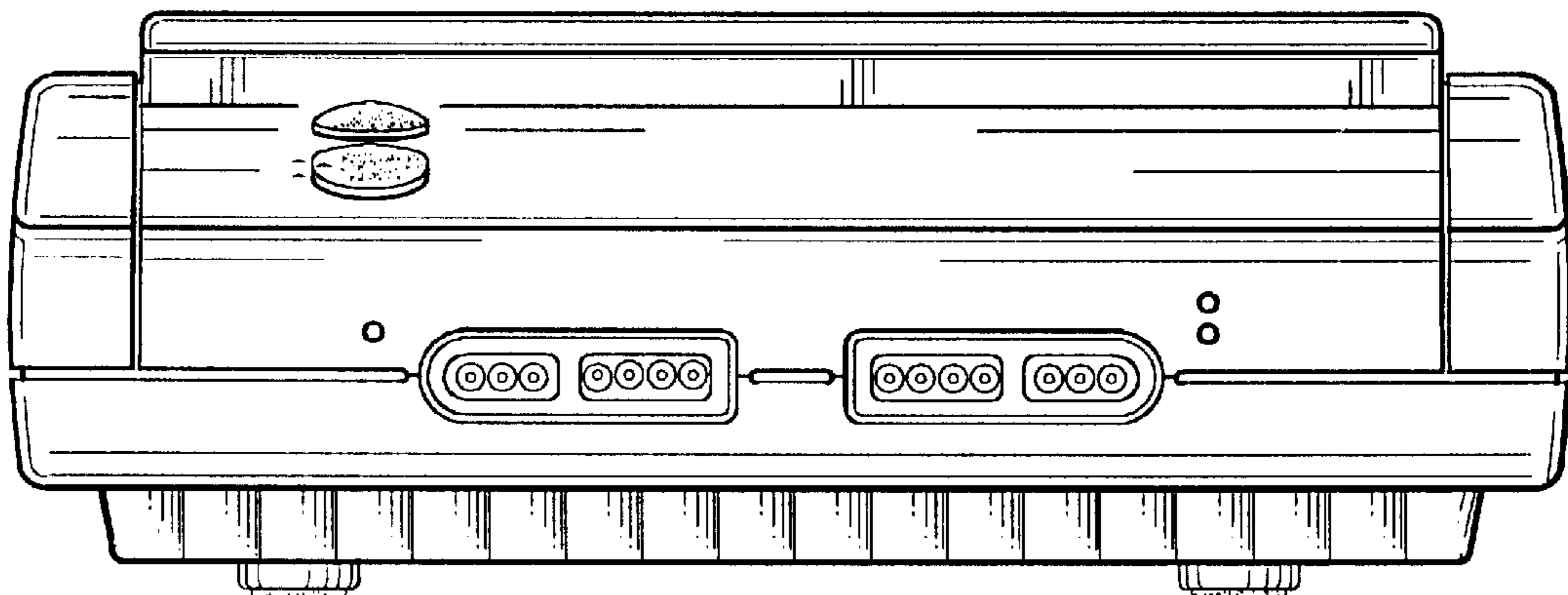

Fig. 2

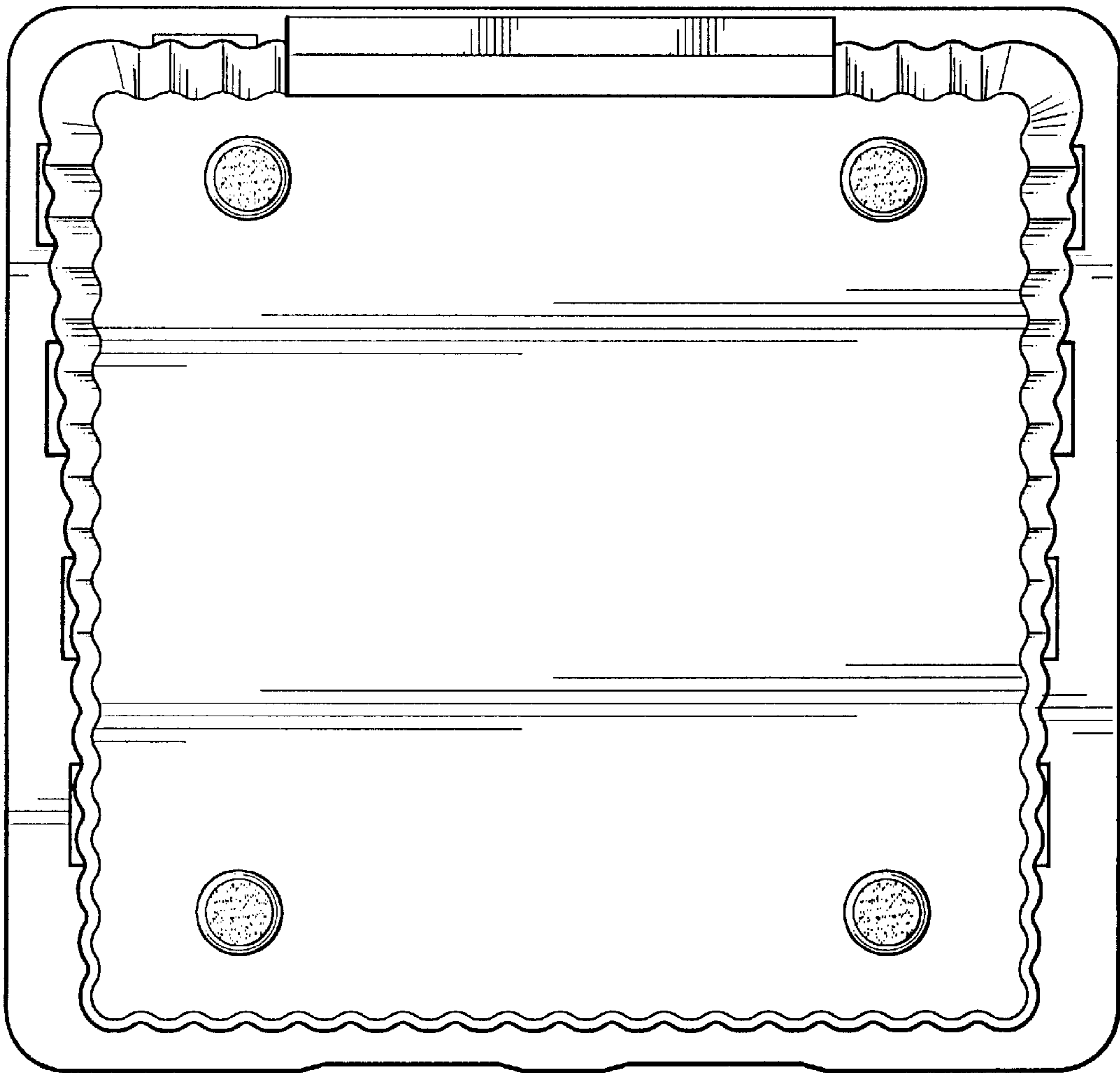

Fig. 3

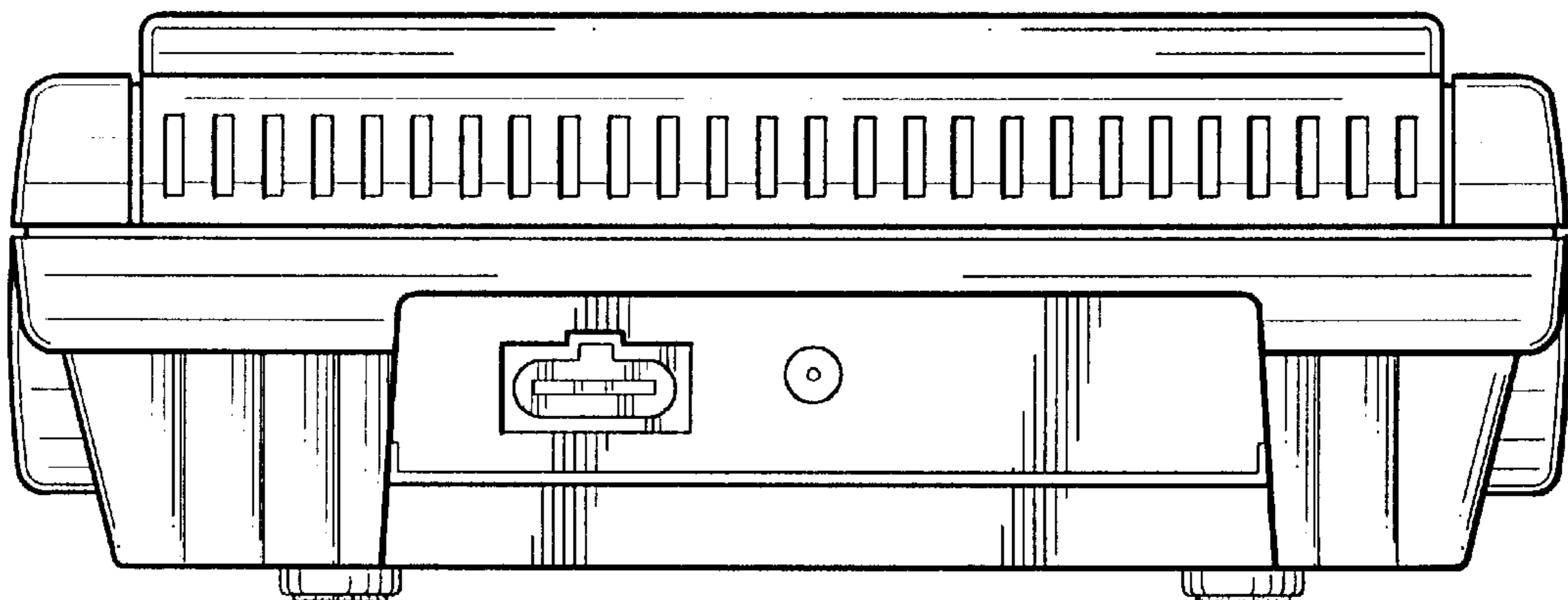

Fig. 4

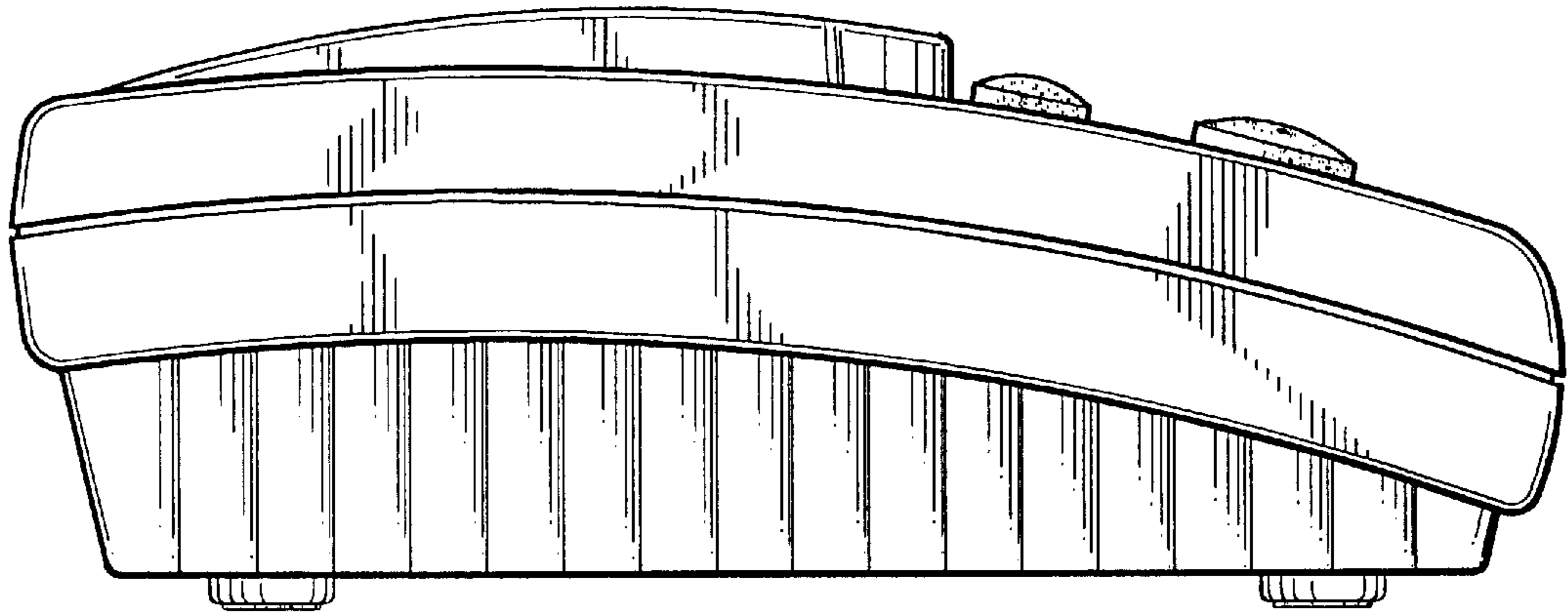

Fig. 5

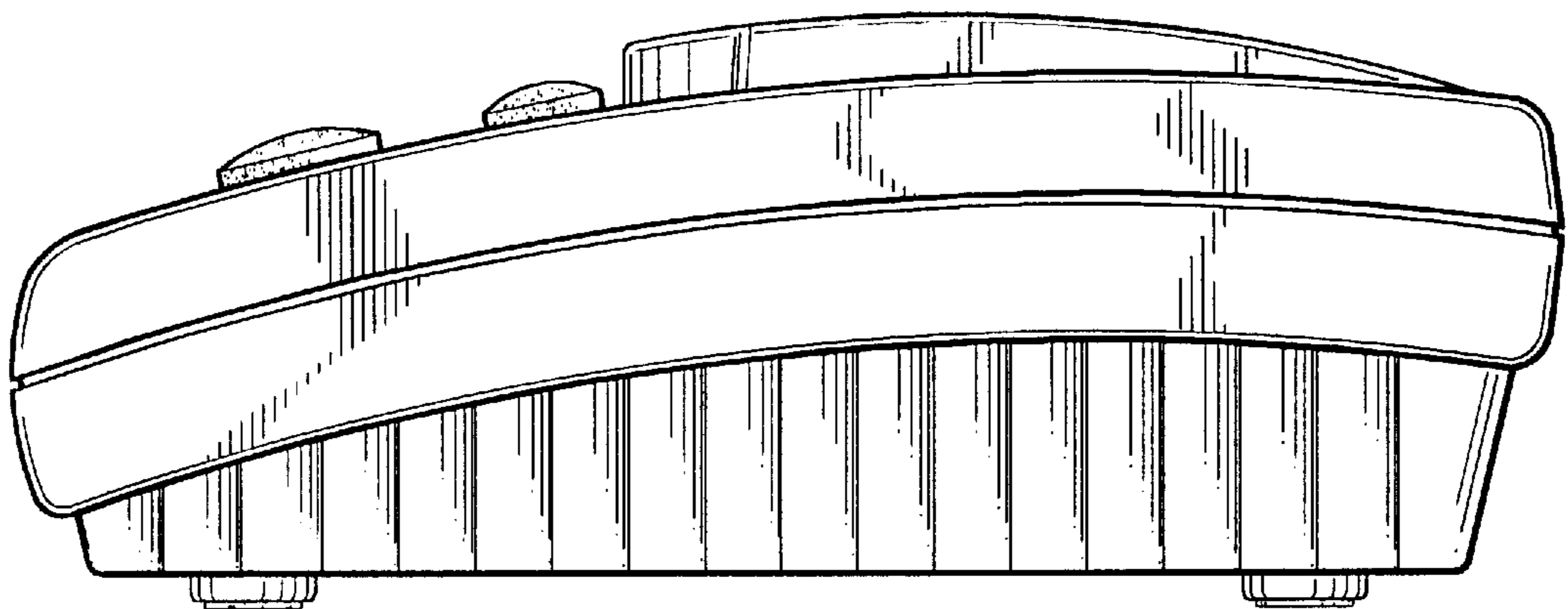

Fig. 6

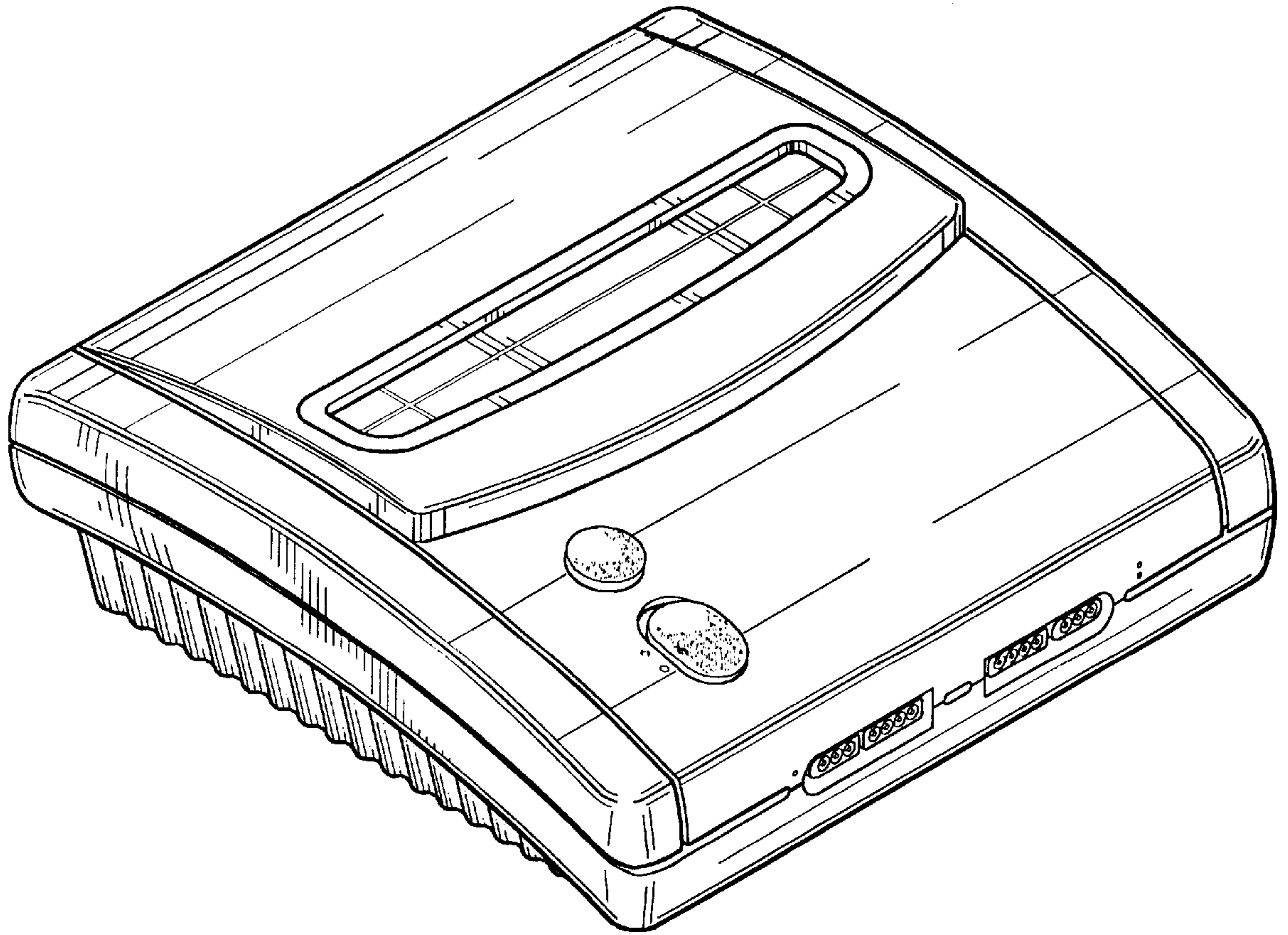

Fig. 7

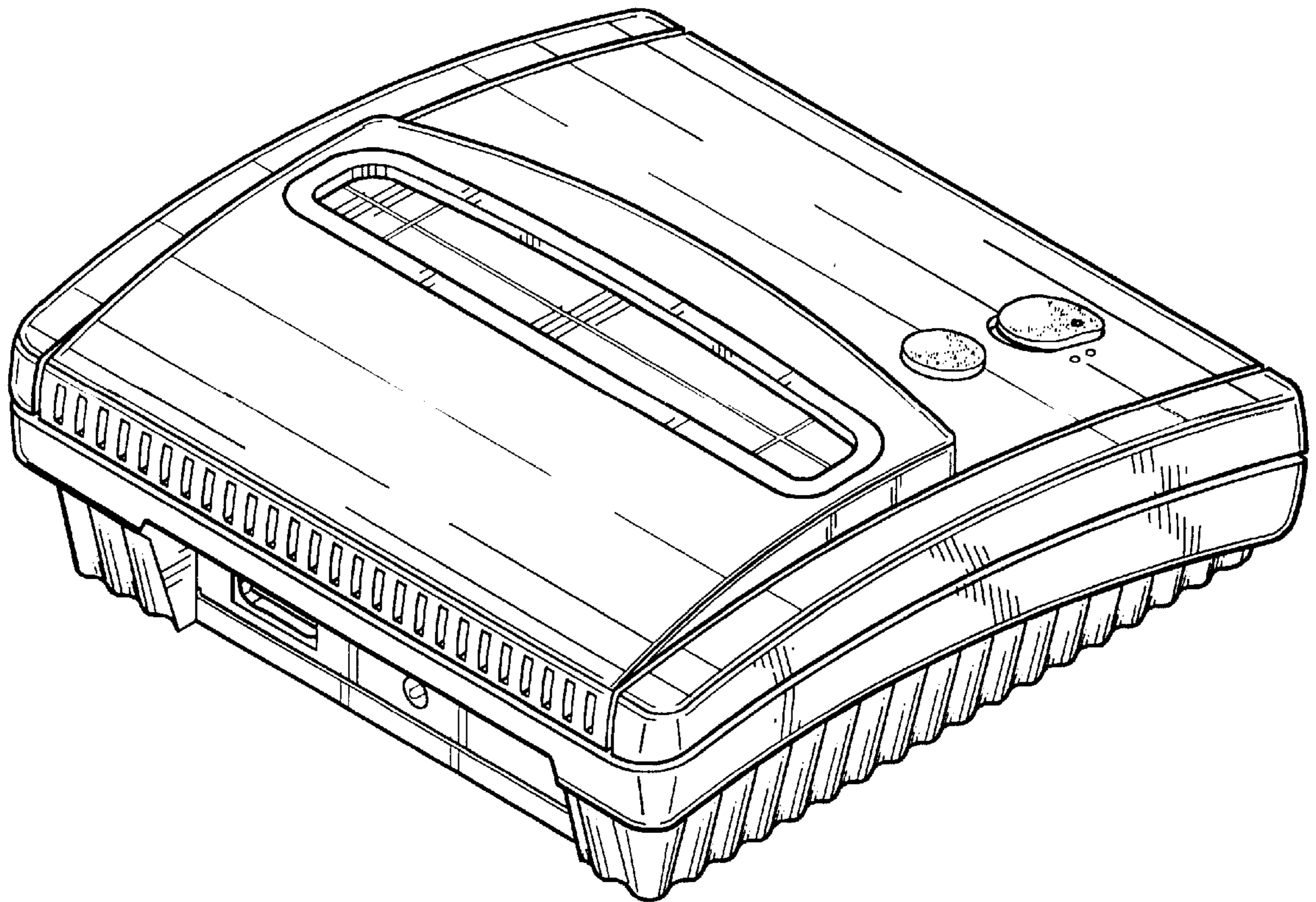

Fig. 8

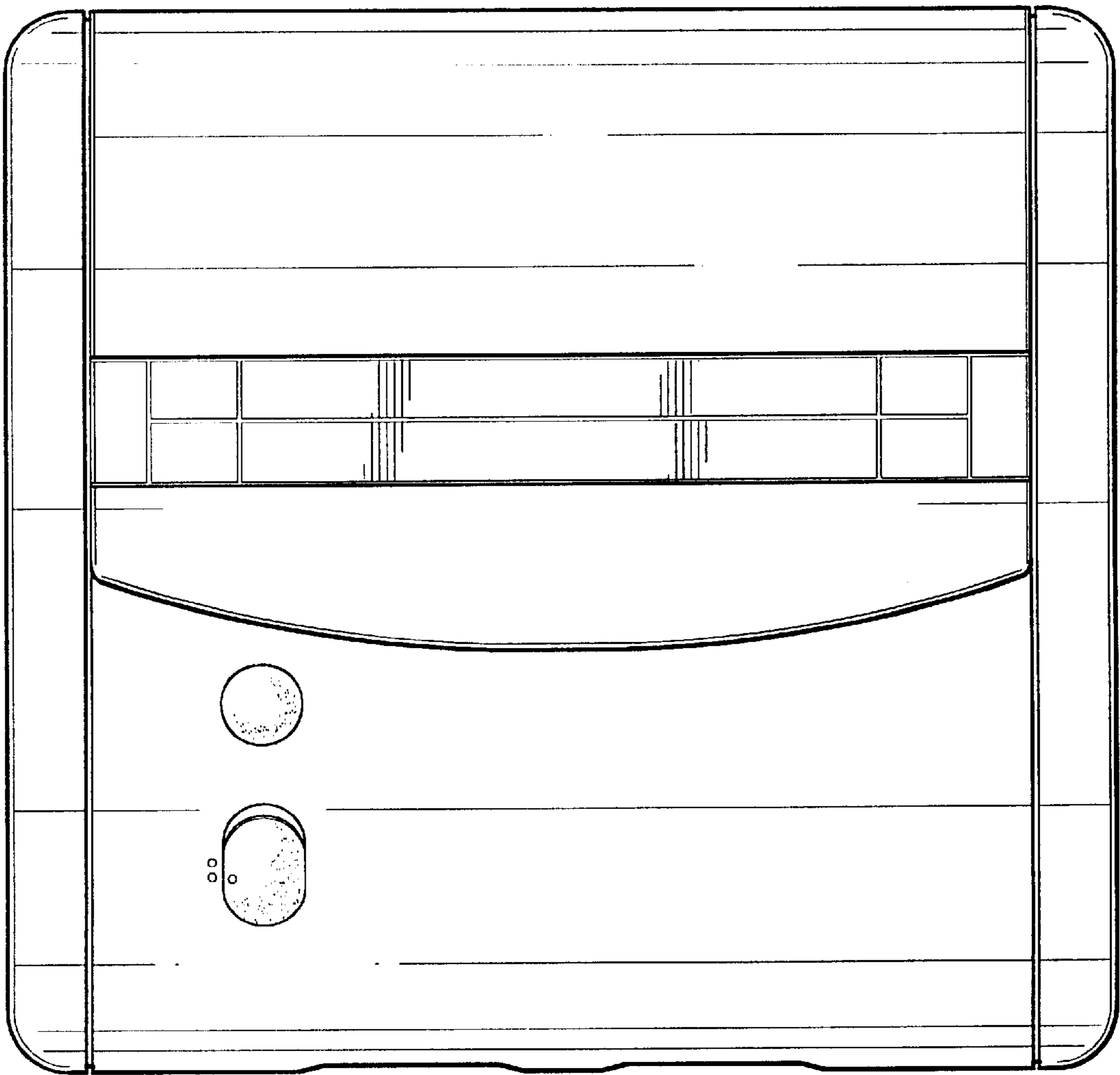

Fig. 9

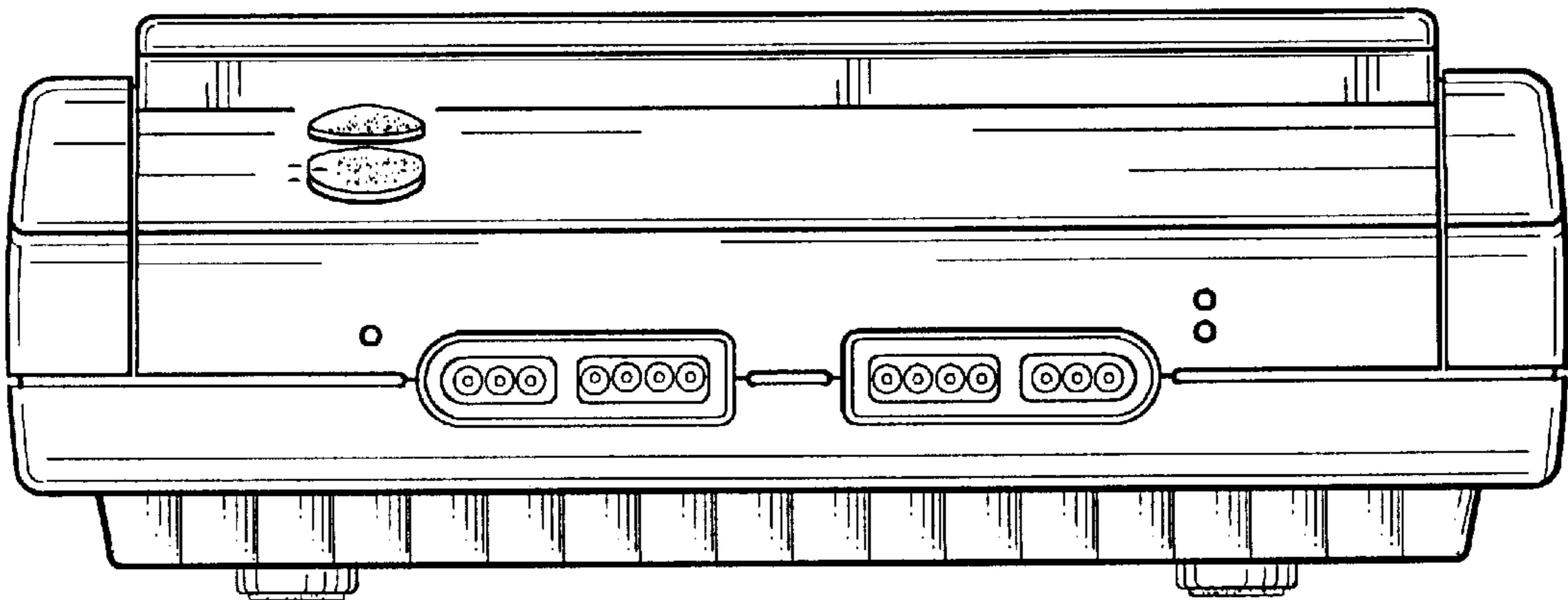

Fig. 10

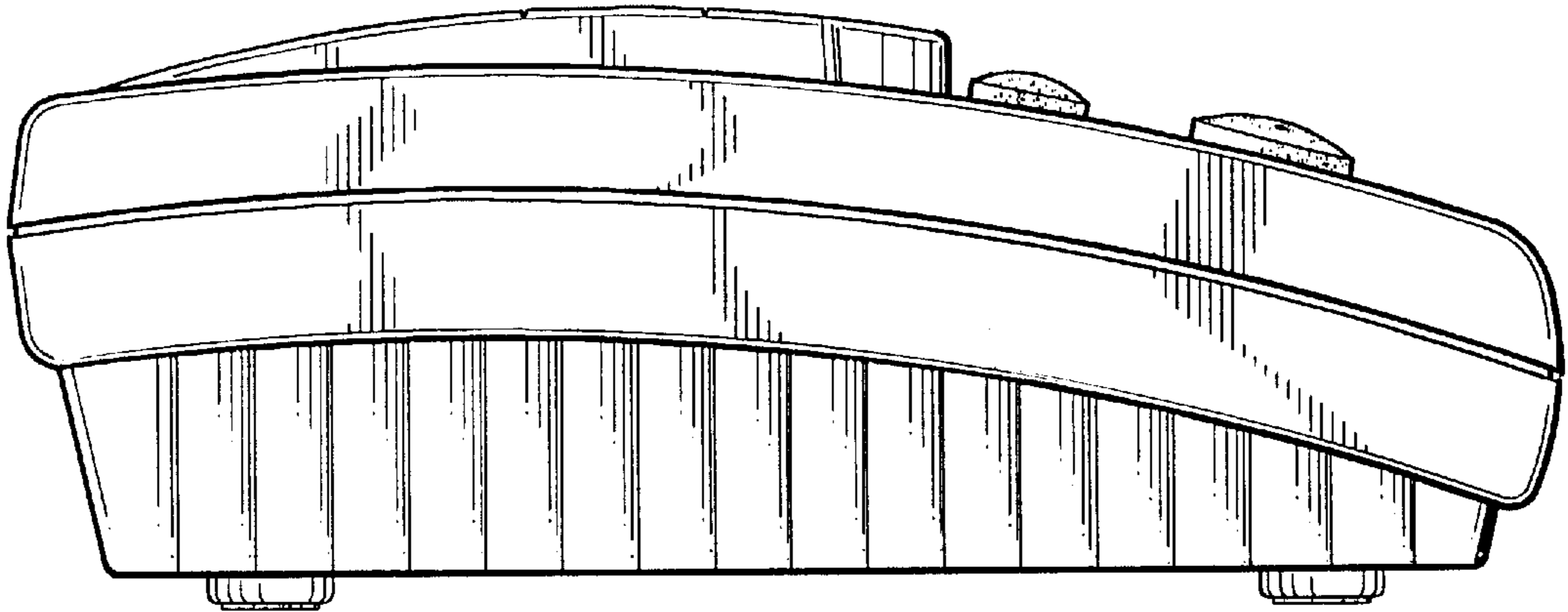

Fig. 11

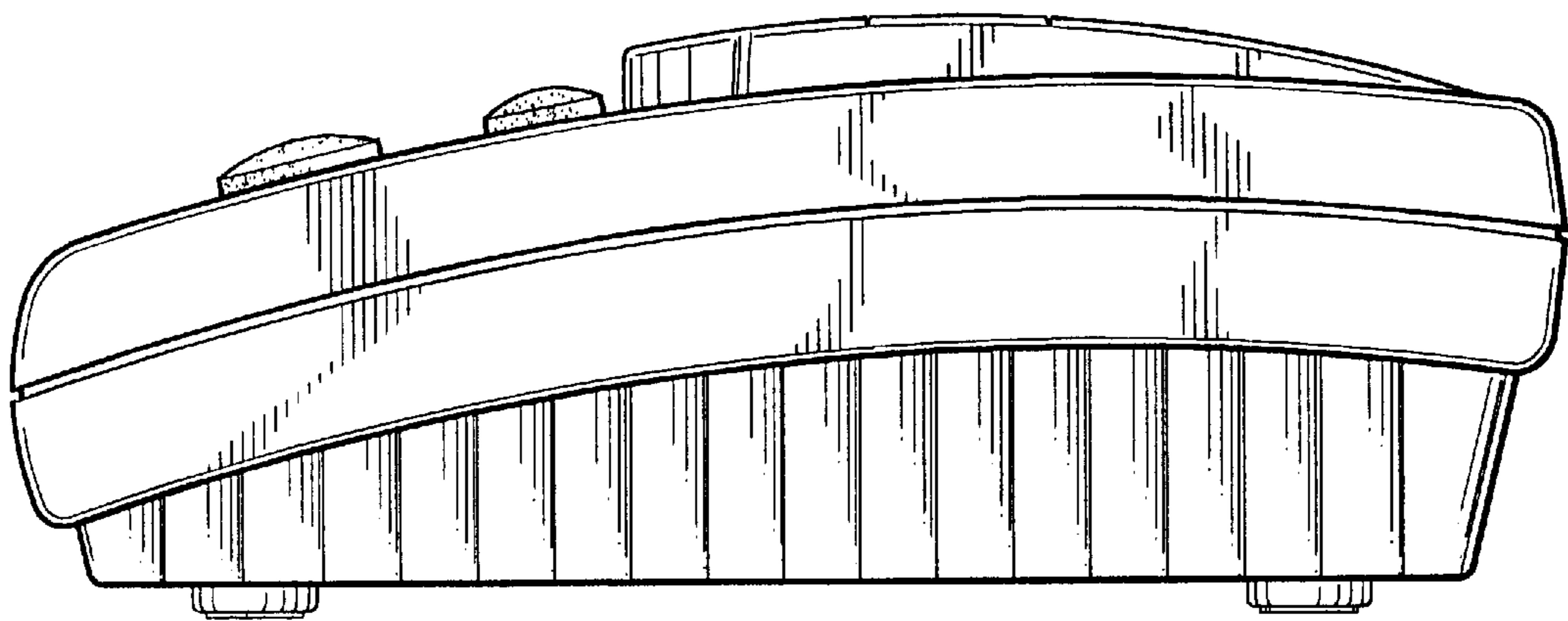

Fig. 12

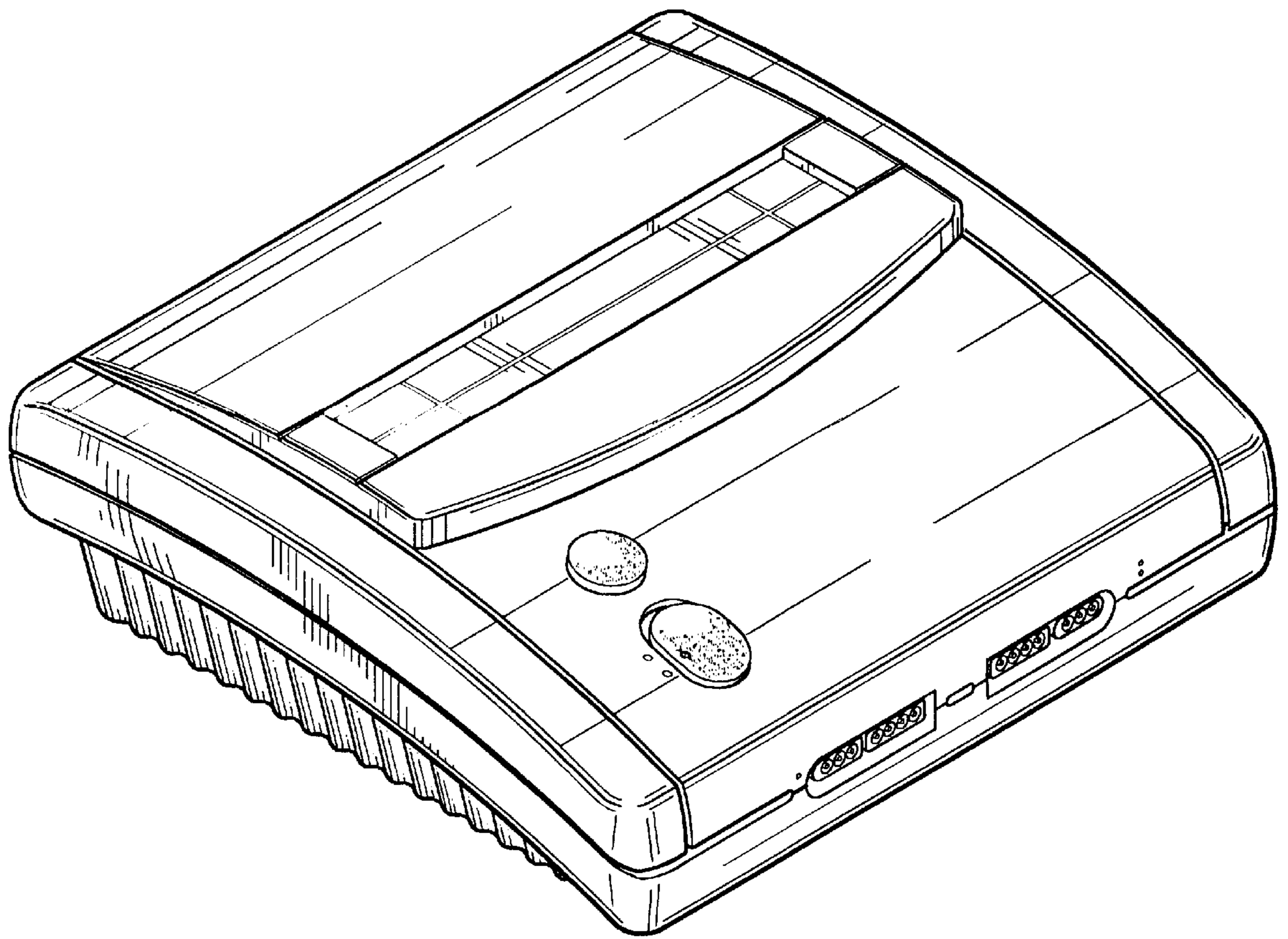

Fig. 13

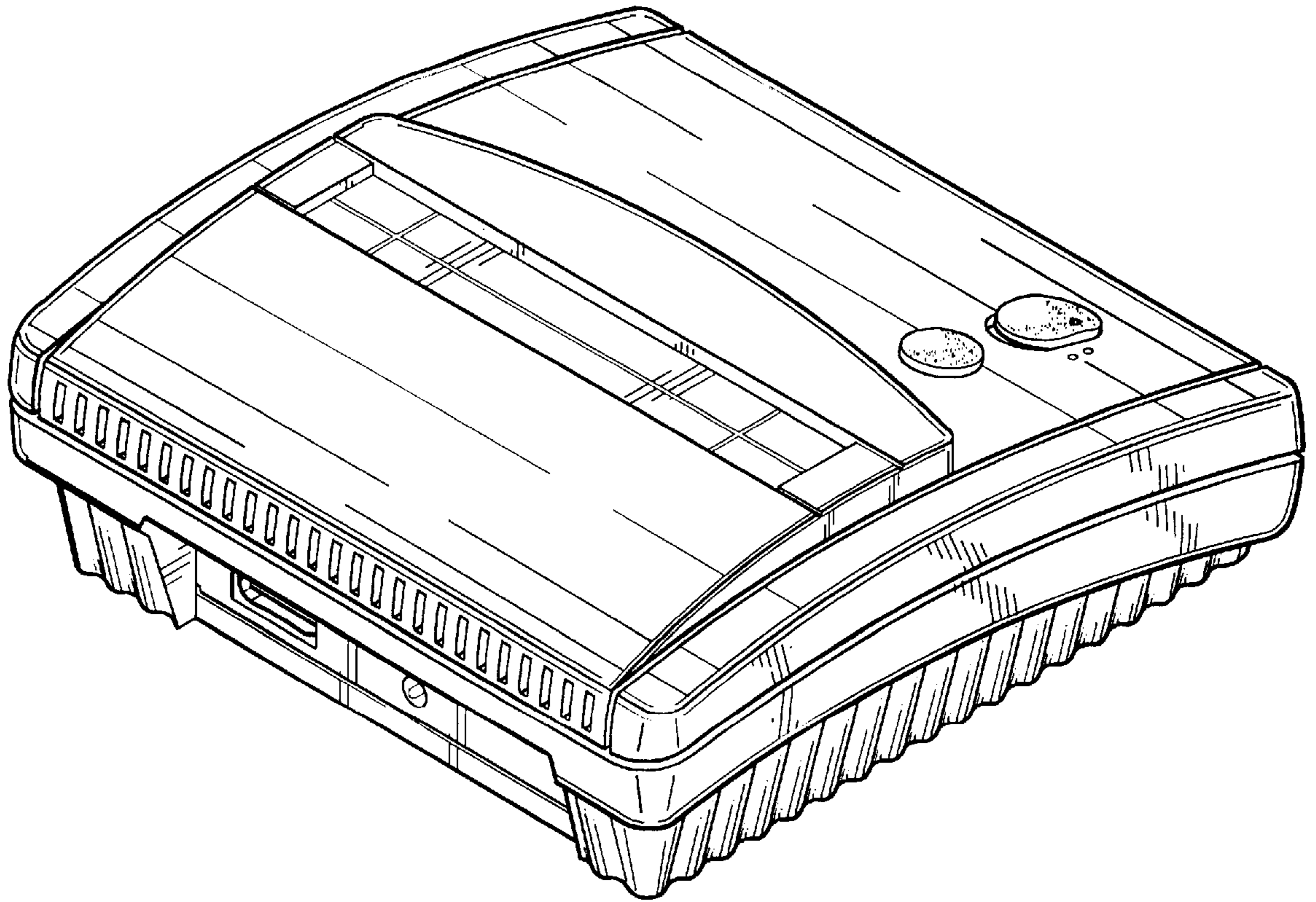

Fig. 14