



US00D407705S

United States Patent [19]
Bryant

[11] **Patent Number: Des. 407,705**

[45] **Date of Patent: **Apr. 6, 1999**

[54] **CAR RADIO INCORPORATING AUDIO PORTIONS OF TELEVISION PROGRAMS**

D. 356,093 3/1995 McCauley et al. D14/157 X
D. 356,316 3/1995 Culbertson D14/257

[76] Inventor: **Viola M. Bryant**, 17545 Meadowood Ave., Lathrup Village, Mich. 48076

Primary Examiner—Ted Shooman
Assistant Examiner—Nanda Bondade

[**] Term: **14 Years**

[57] **CLAIM**

[21] Appl. No.: **77,949**

The ornamental design for a car radio incorporating audio portions of television programs, as shown and described.

[22] Filed: **Oct. 14, 1997**

DESCRIPTION

[51] **LOC (6) Cl.** **14-03**

[52] **U.S. Cl.** **D14/157**

[58] **Field of Search** D14/124, 137,
D14/157, 257, 258, 299; 455/73, 89-90,
128, 345-347

FIG. 1 is a perspective view of the car radio incorporating audio portions of television programs showing my new design;

FIG. 2 is an enlarged front elevational view thereof;

FIG. 3 is a rear elevational view thereof;

FIG. 4 is a right side elevational view thereof;

FIG. 5 is a left side elevational view thereof;

FIG. 6 is a top plan view thereof; and,

FIG. 7 is a bottom plan view thereof.

[56] **References Cited**

U.S. PATENT DOCUMENTS

D. 314,966 2/1991 Magic et al. D14/157 X
D. 350,964 9/1994 Fowler et al. D14/157 X

1 Claim, 4 Drawing Sheets

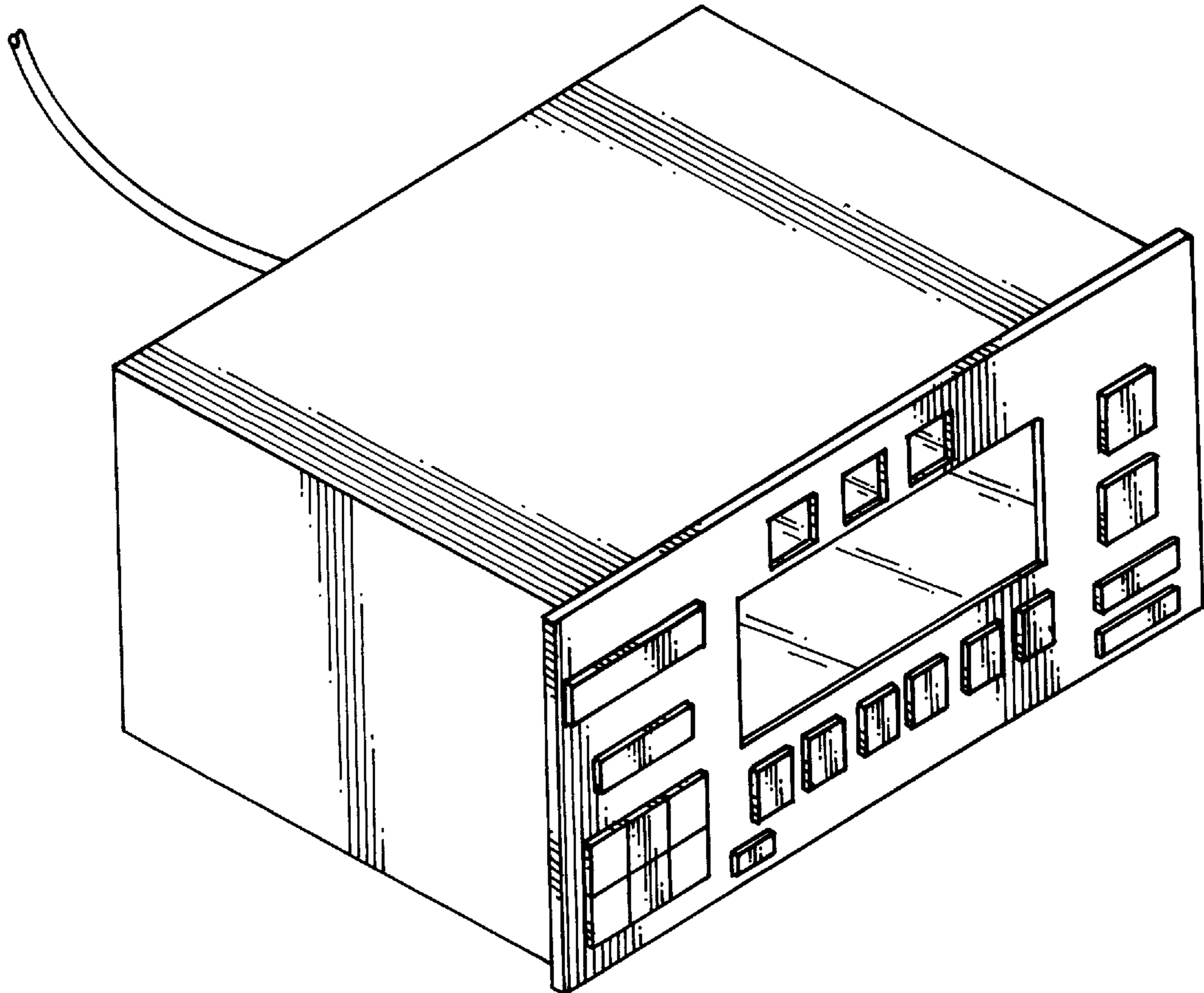

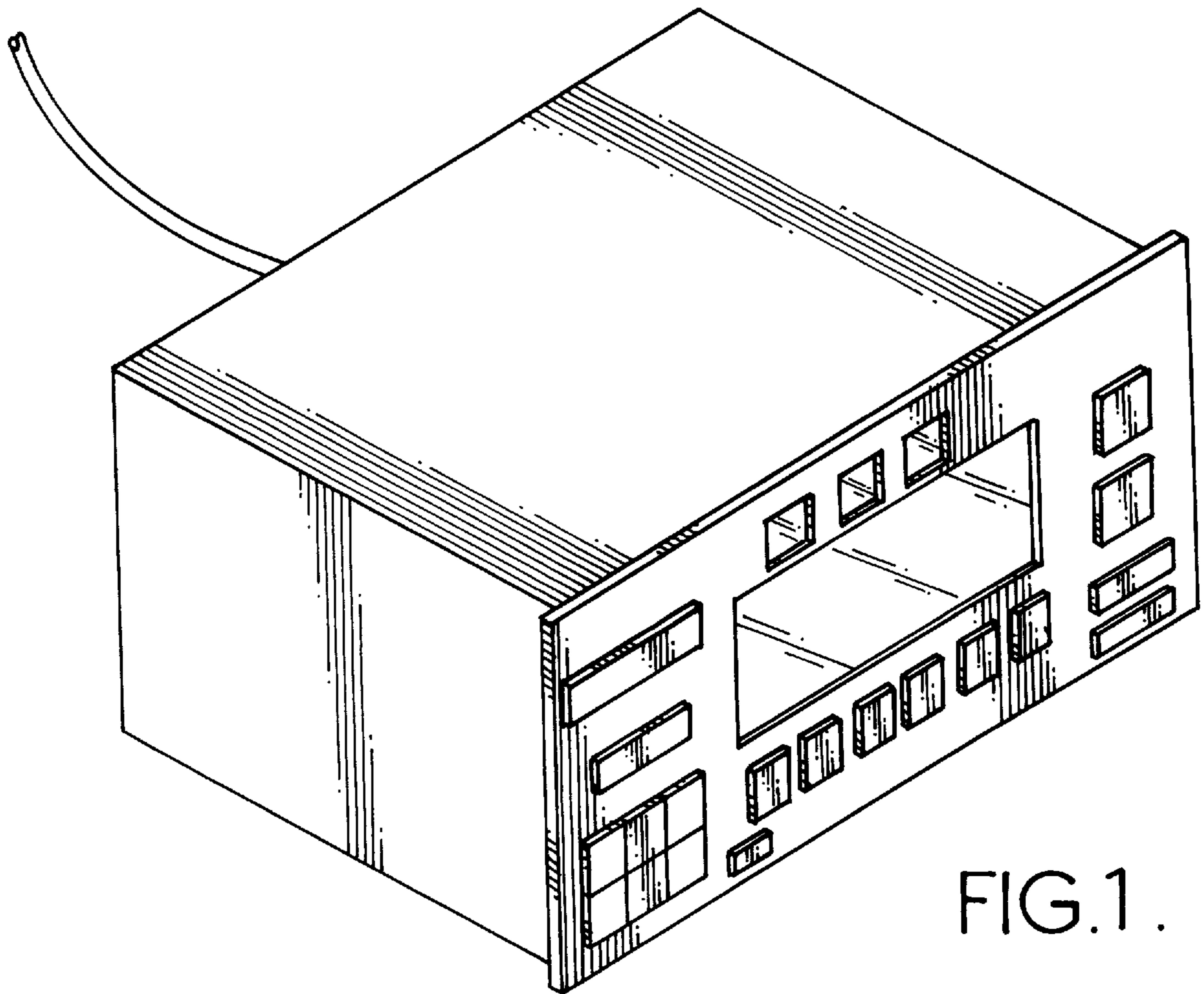

FIG.1.

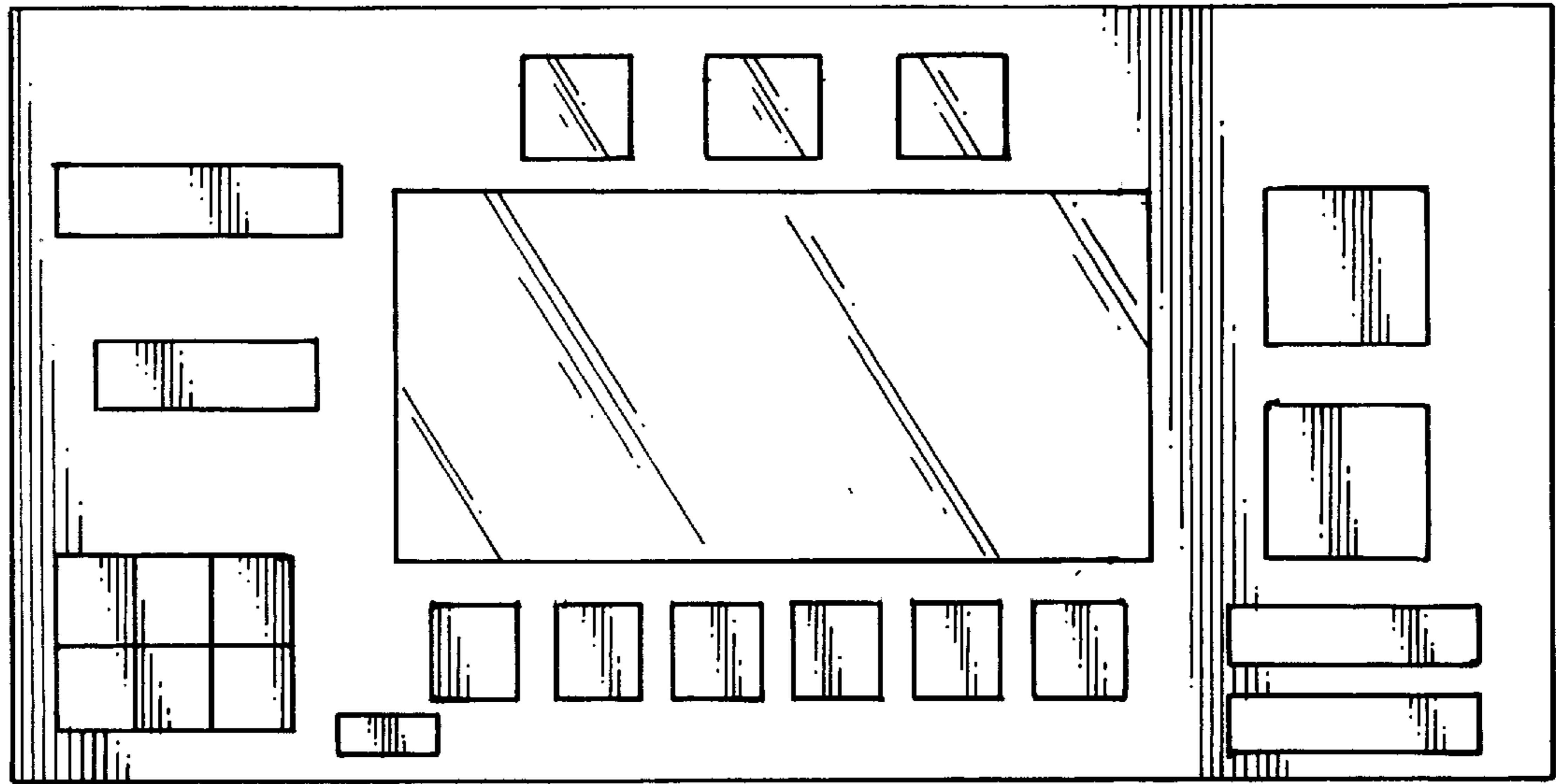

FIG. 2.

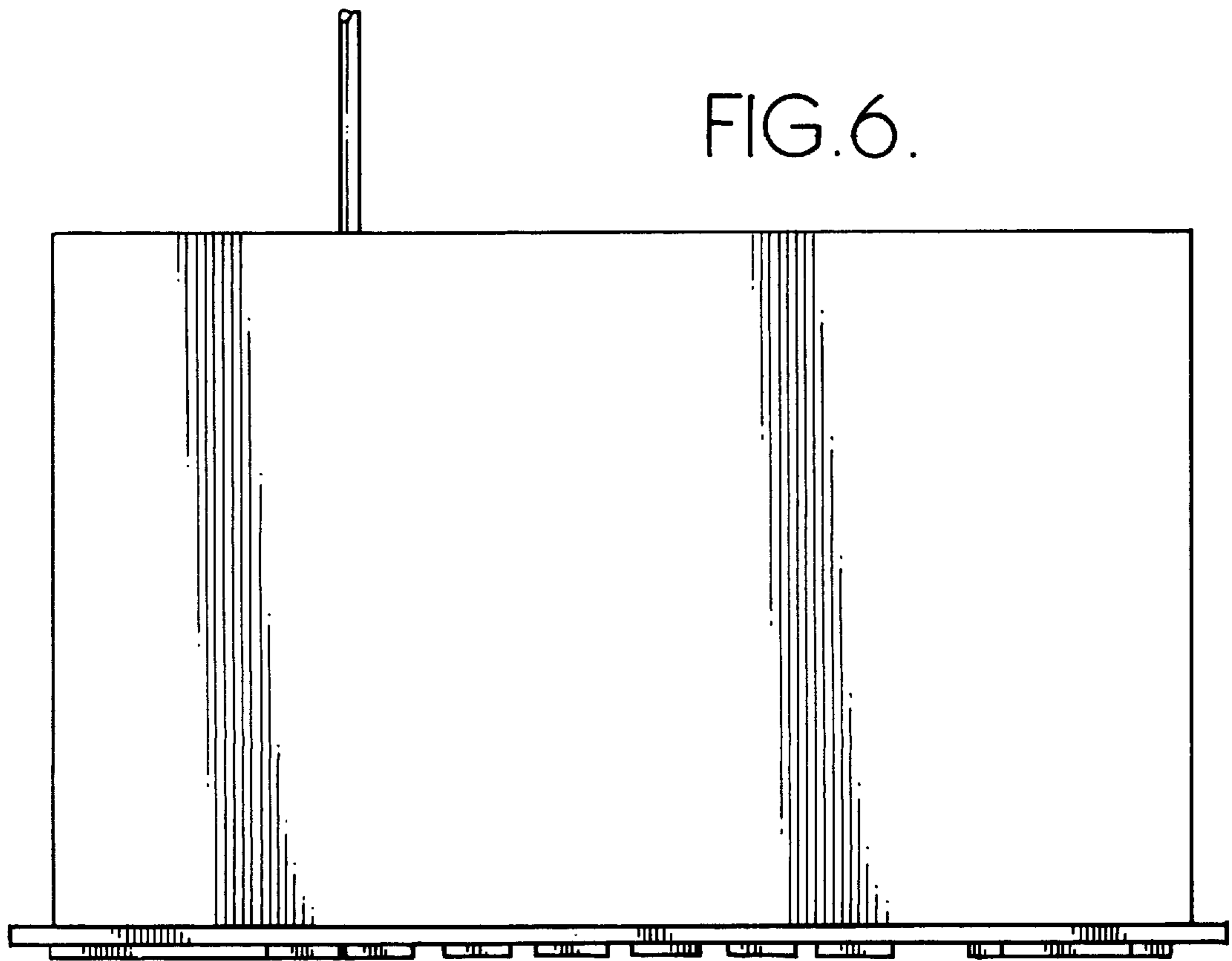

FIG. 6.

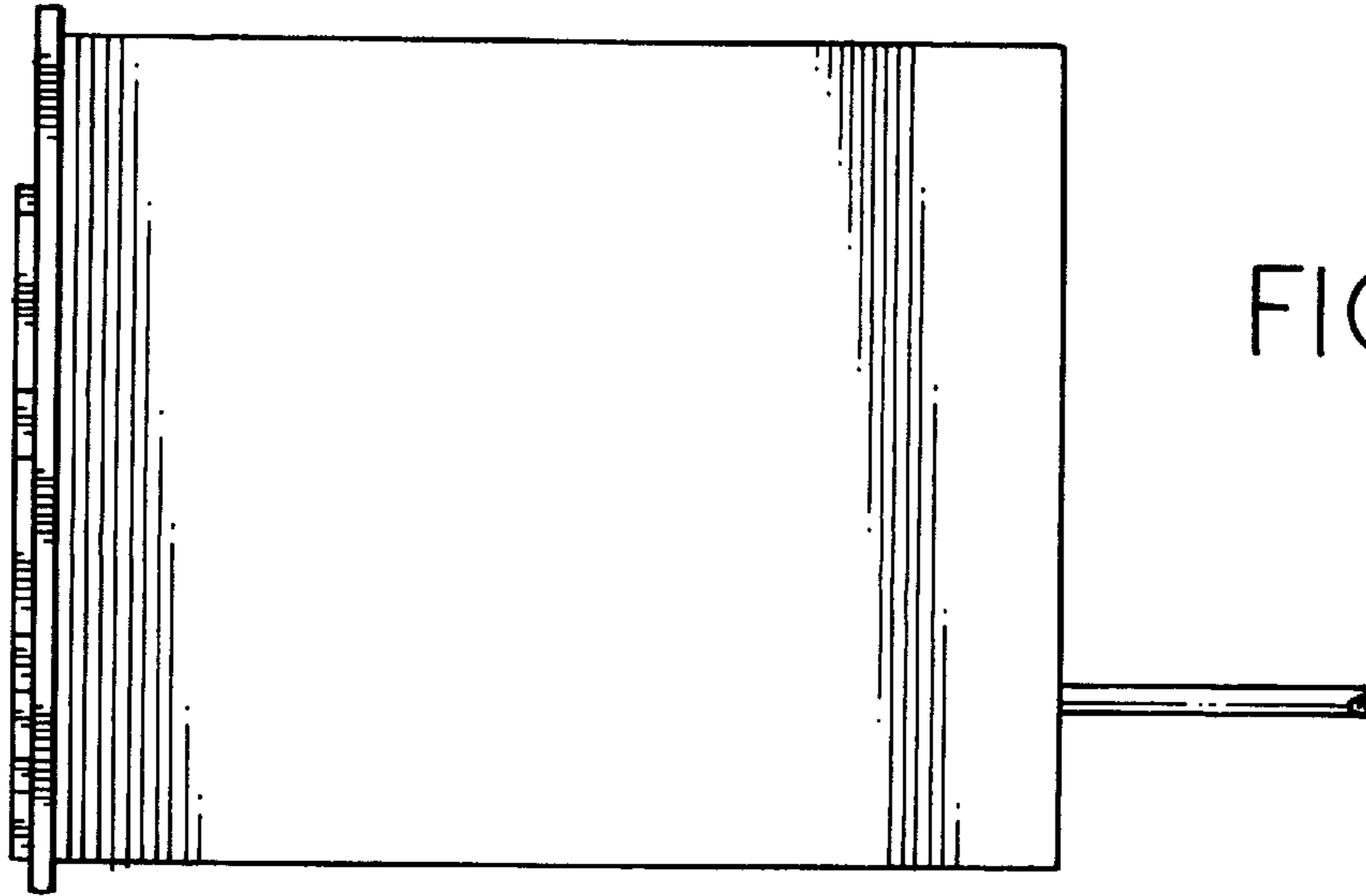

FIG. 4.

FIG. 3.

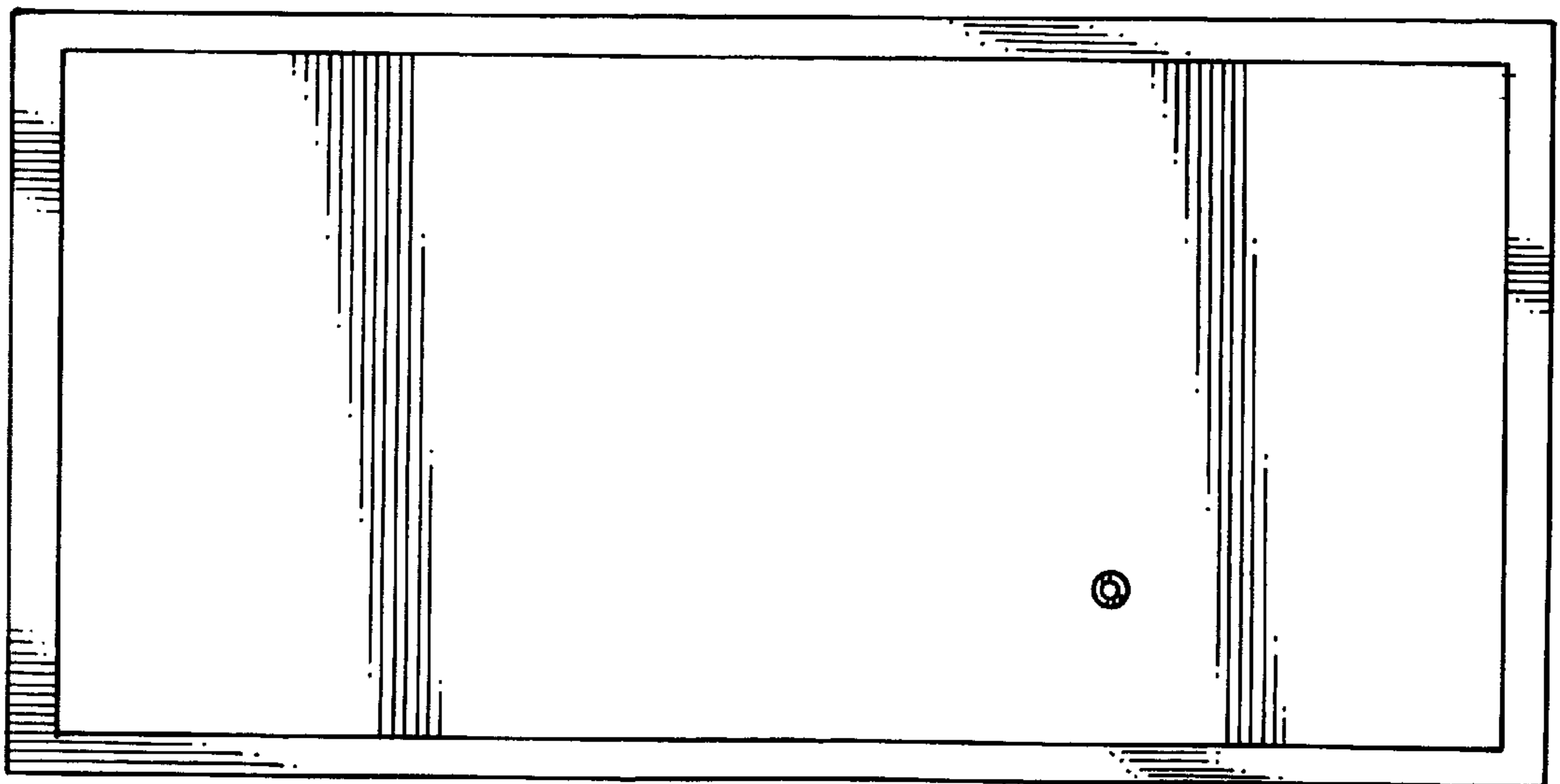

FIG. 5.

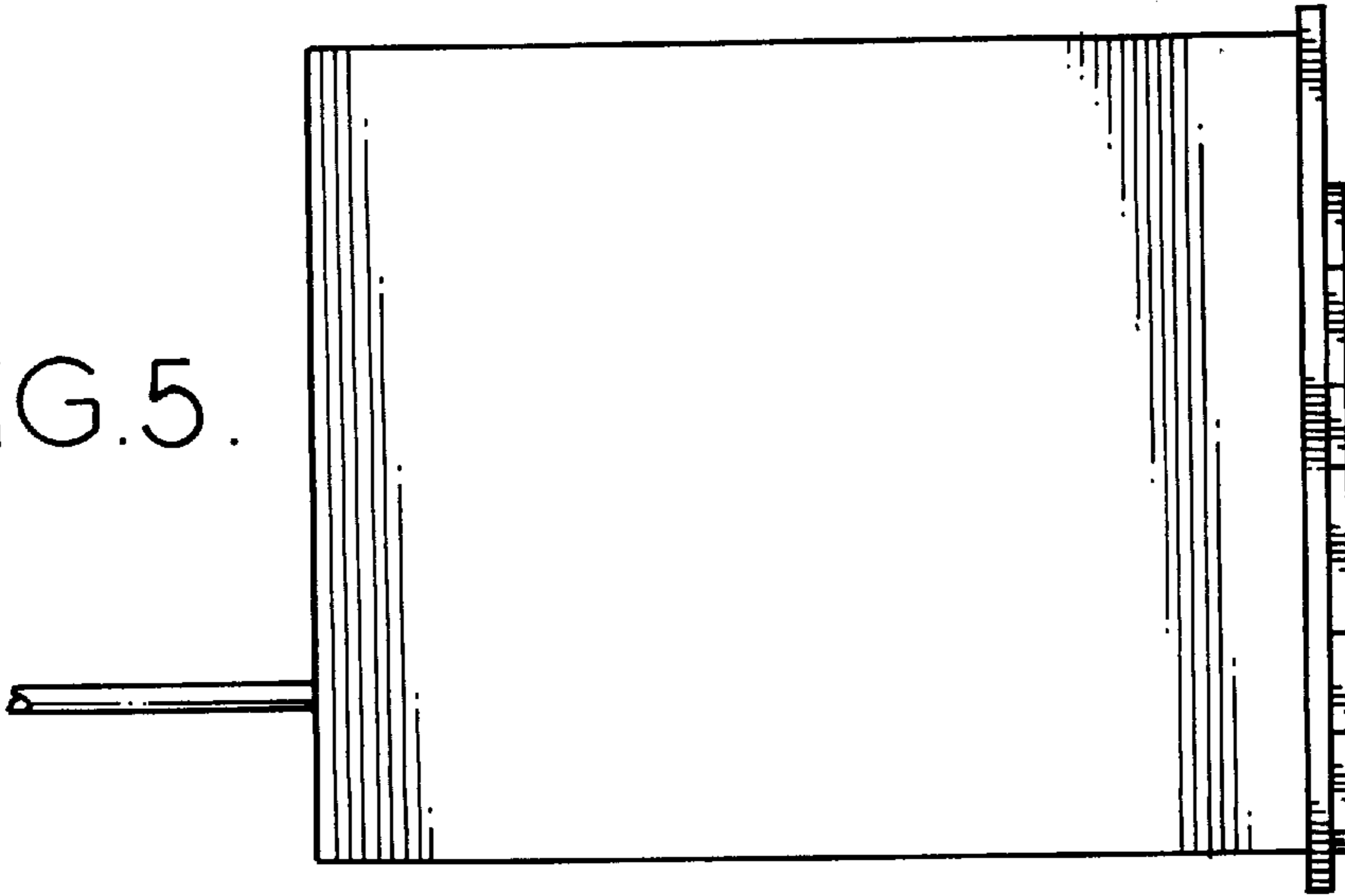

FIG. 7.

