



US00D407667S

**United States Patent** [19]  
**Homeier**

[11] **Patent Number: Des. 407,667**

[45] **Date of Patent: \*\*Apr. 6, 1999**

[54] **HOUSING FOR BUCKLE AND MOUNT**

[75] Inventor: **Ronald F. Homeier**, Plainfield, Ind.

[73] Assignee: **Indiana Mills & Manufacturing, Inc.**,  
Westfield, Ind.

[\*\*] Term: **14 Years**

[21] Appl. No.: **84,817**

[22] Filed: **Mar. 10, 1998**

[51] **LOC (6) Cl.** ..... **12-07**

[52] **U.S. Cl.** ..... **D11/216**

[58] **Field of Search** ..... D11/200, 216-220;  
D9/393; 24/265 R, 265 E; 297/468, 466,  
488, 475, 482; 280/801.1, 270

[56] **References Cited**

**U.S. PATENT DOCUMENTS**

D. 353,932	1/1995	New	.....	D11/216
3,287,063	11/1966	Nicholas	.....	297/475
3,572,832	3/1971	Graham	.....	297/482
4,611,854	9/1986	Pfeiffer	.....	297/488

*Primary Examiner*—Ralf Seifert  
*Attorney, Agent, or Firm*—Woodard, Emhardt, Naughton,  
Moriarty & McNett

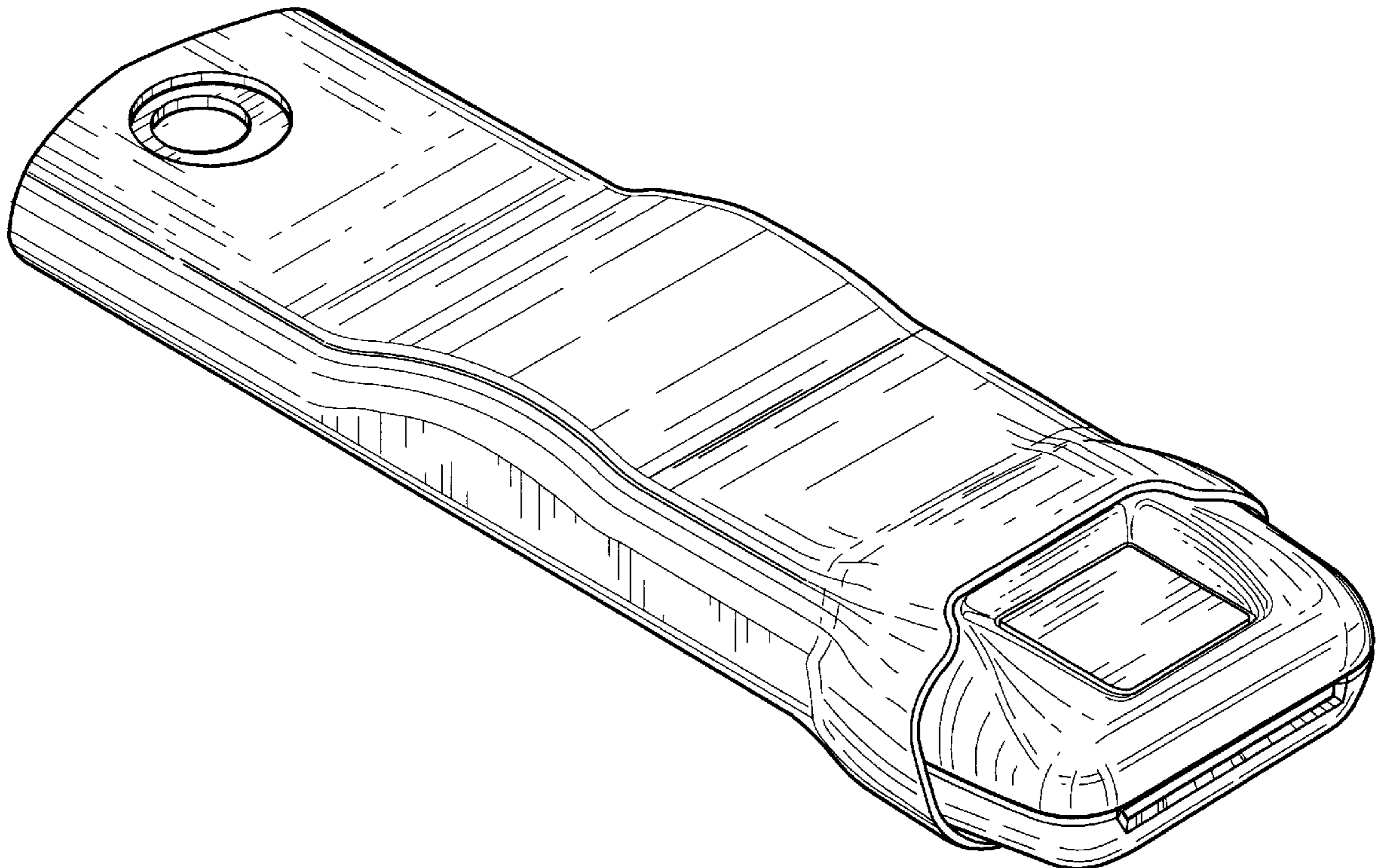
[57] **CLAIM**

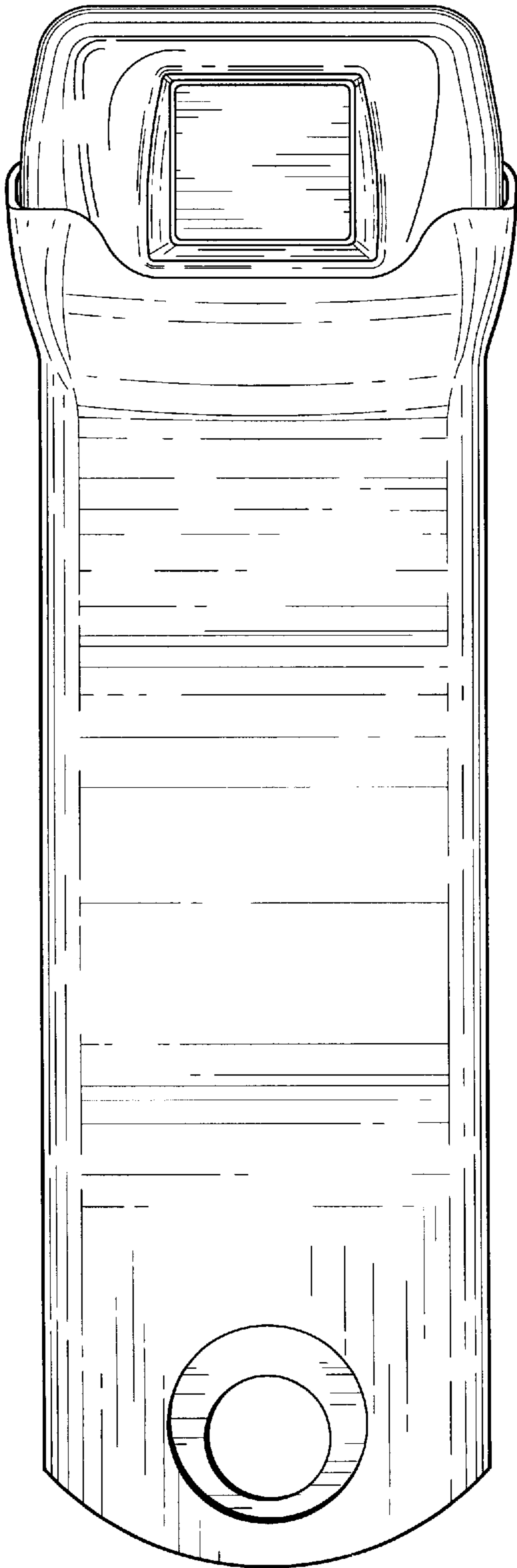
The ornamental design for a housing for buckle and mount,  
as shown and described.

**DESCRIPTION**

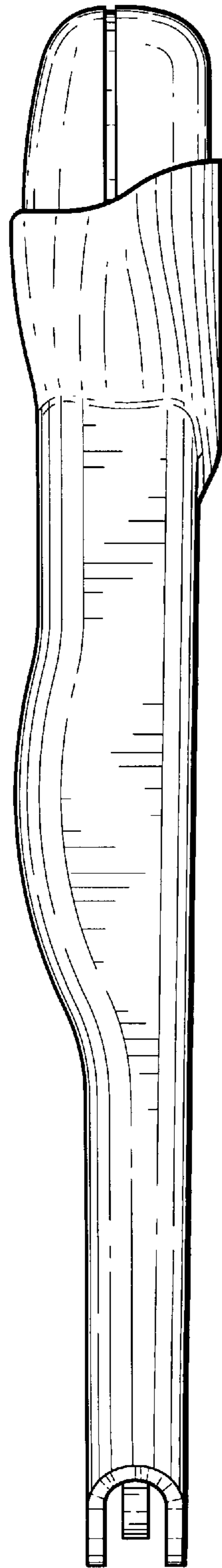
FIG. 1 is a side view of the preferred embodiment of the housing incorporating my new design with the opposite side view being a mirror image thereof;  
FIG. 2 is a top view;  
FIG. 3 is a bottom view;  
FIG. 4 is a right end view of the housing of FIG. 1;  
FIG. 5 is a left end view of the housing of FIG. 1;  
FIG. 6 is a perspective view;  
FIG. 7 is a perspective view of a first alternate embodiment;  
FIG. 8 is a side view of the housing of FIG. 7 with the opposite side view being a mirror image thereof;  
FIG. 9 is a top view of the housing of FIG. 7;  
FIG. 10 is a bottom view of the housing of FIG. 7;  
FIG. 11 is a left end view of the housing of FIG. 7;  
FIG. 12 is a right end view of the housing of FIG. 7;  
FIG. 13 is a perspective view of a second alternate embodiment;  
FIG. 14 is a side view of housing of FIG. 13 with the opposite side view being a mirror image thereof;  
FIG. 15 is a top view of the housing of FIG. 13;  
FIG. 16 is a bottom view of the housing of FIG. 13;  
FIG. 17 is a left end view of the housing of FIG. 13; and,  
FIG. 18 is a right end view of the housing of FIG. 13.

**1 Claim, 8 Drawing Sheets**

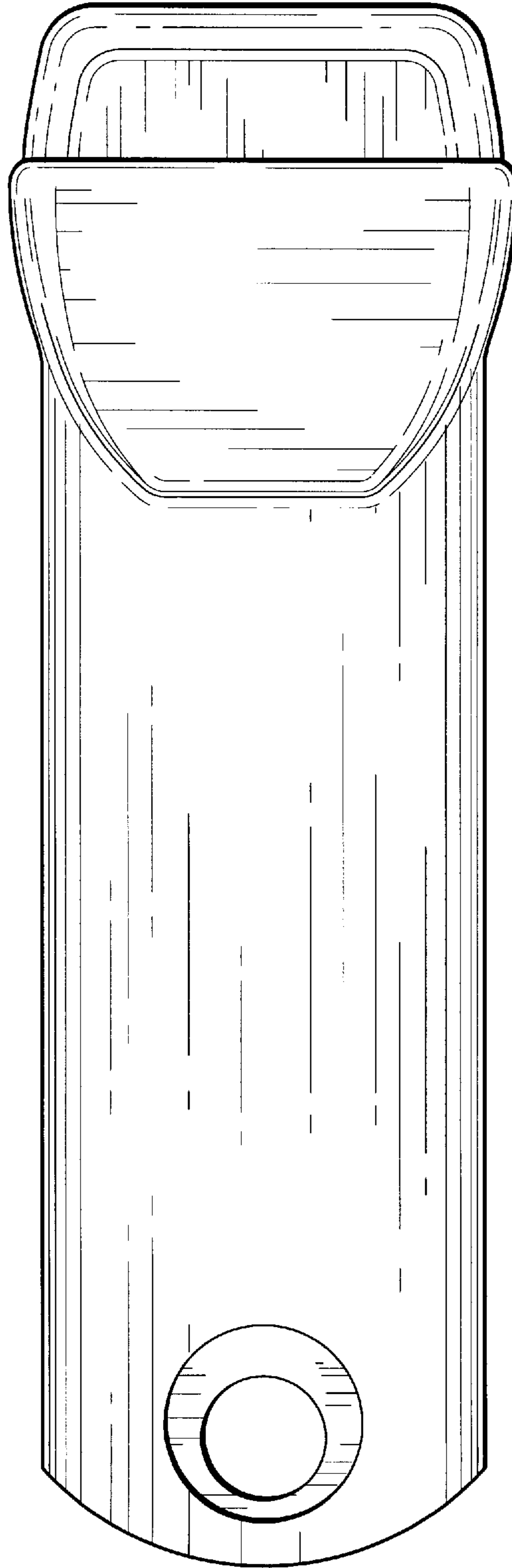




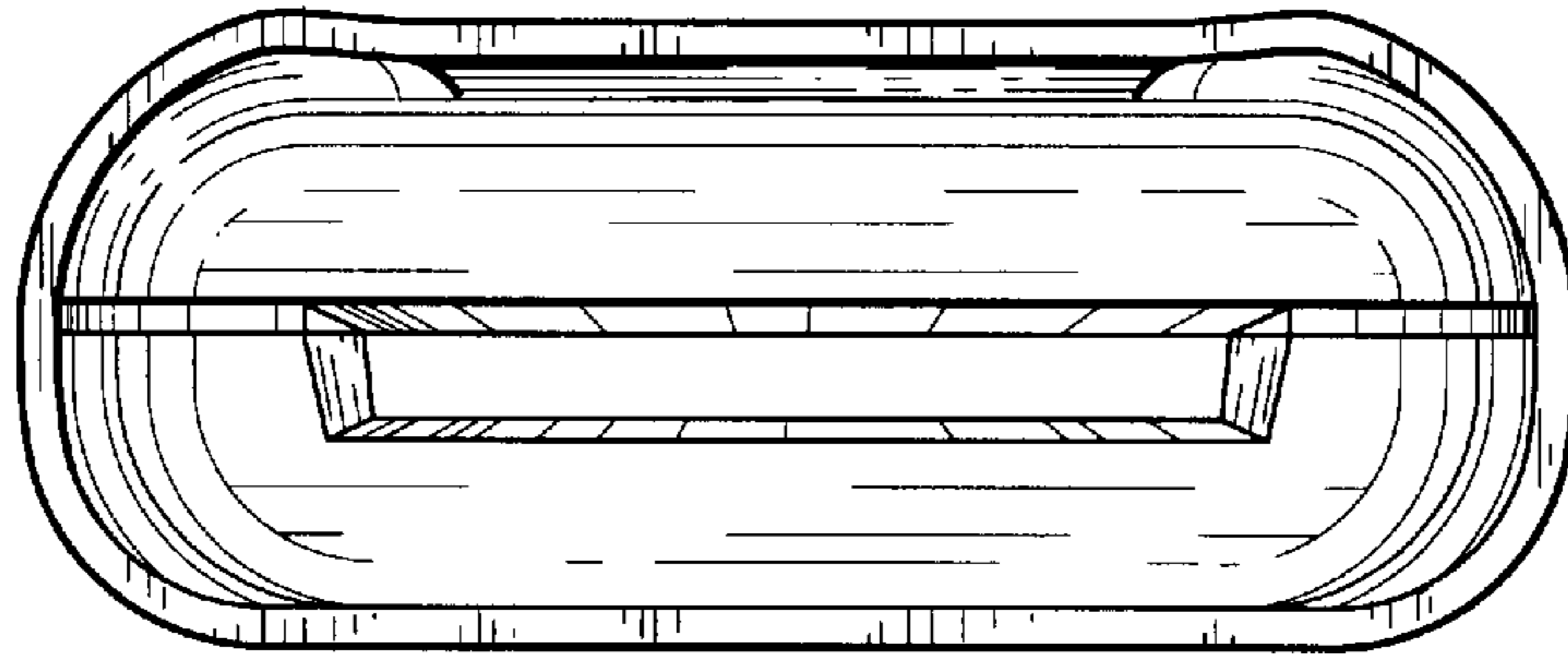
**Fig. 2**



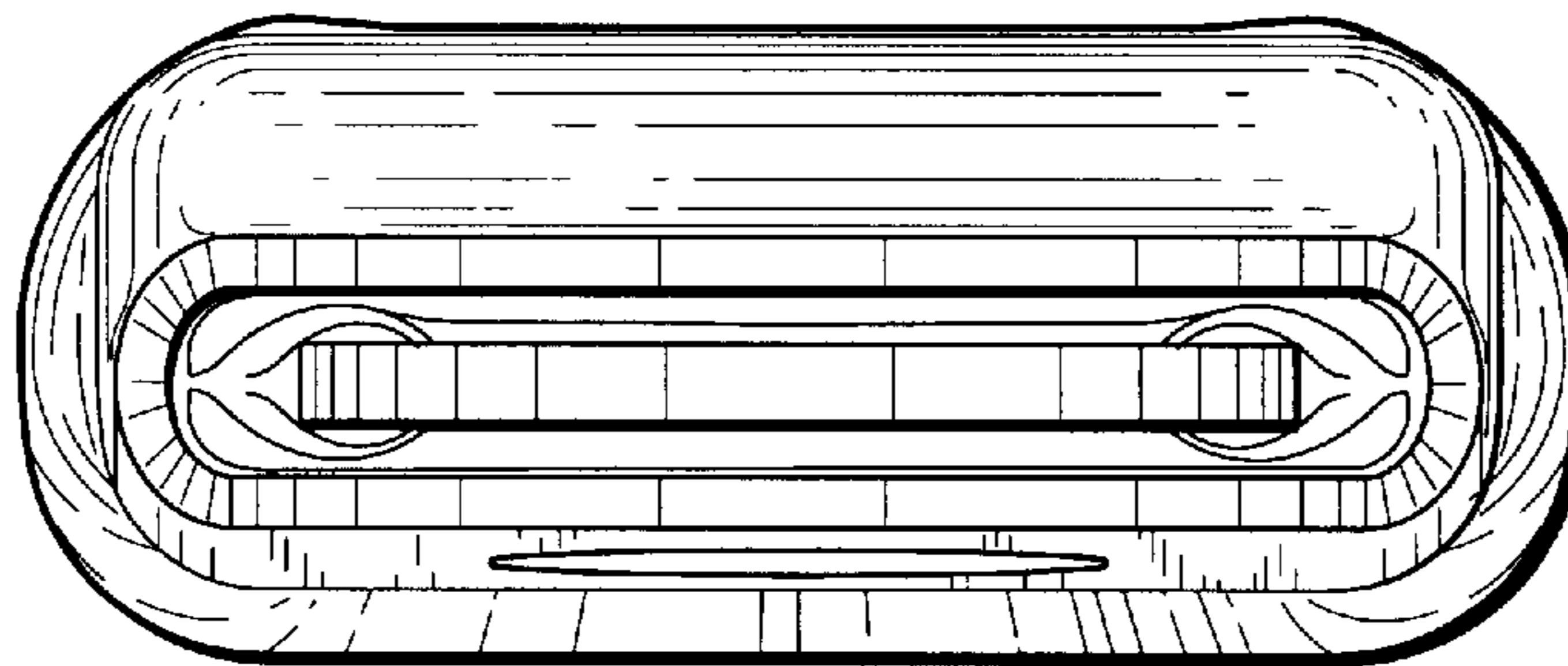
**Fig. 1**



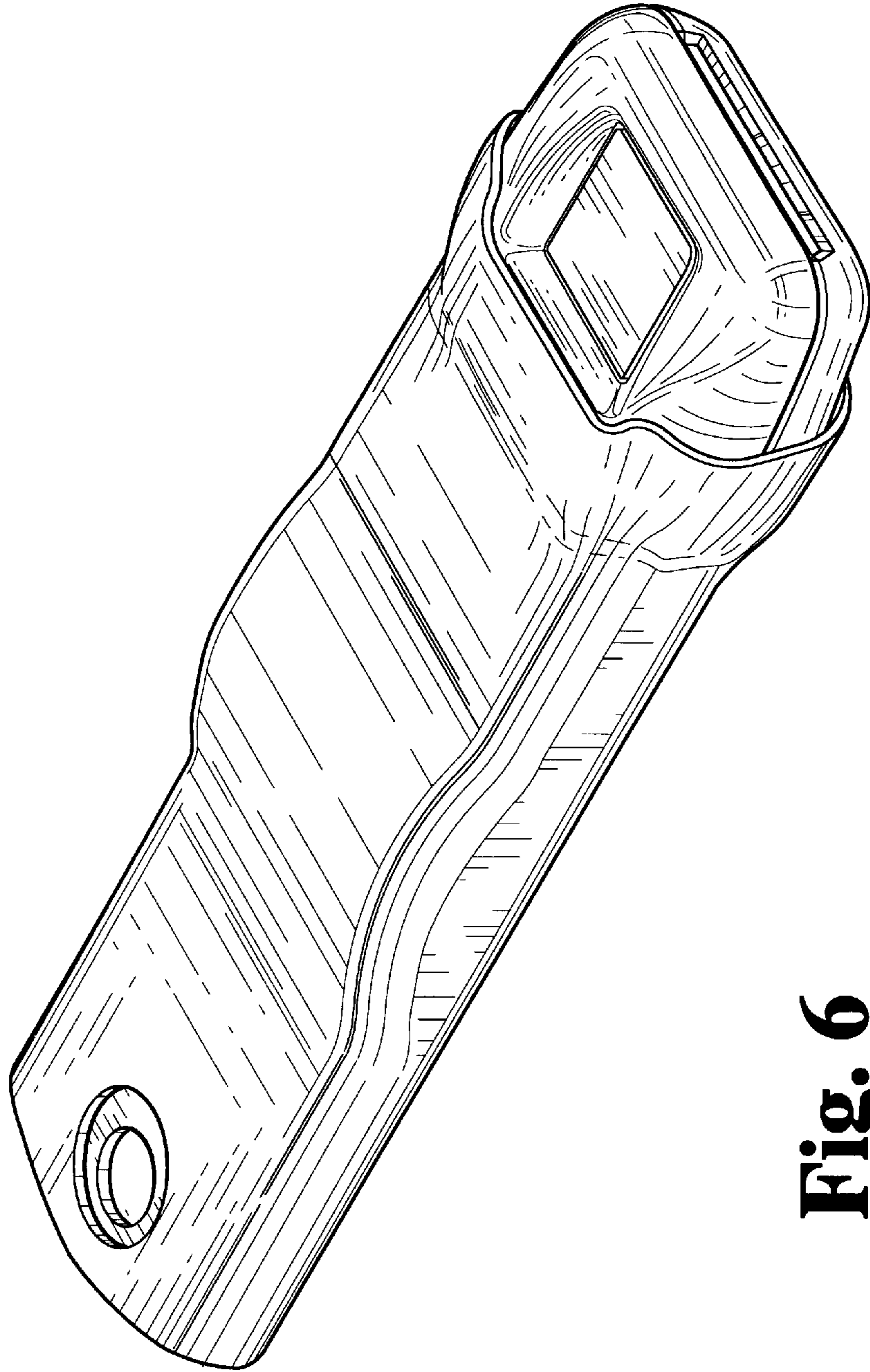
**Fig. 3**



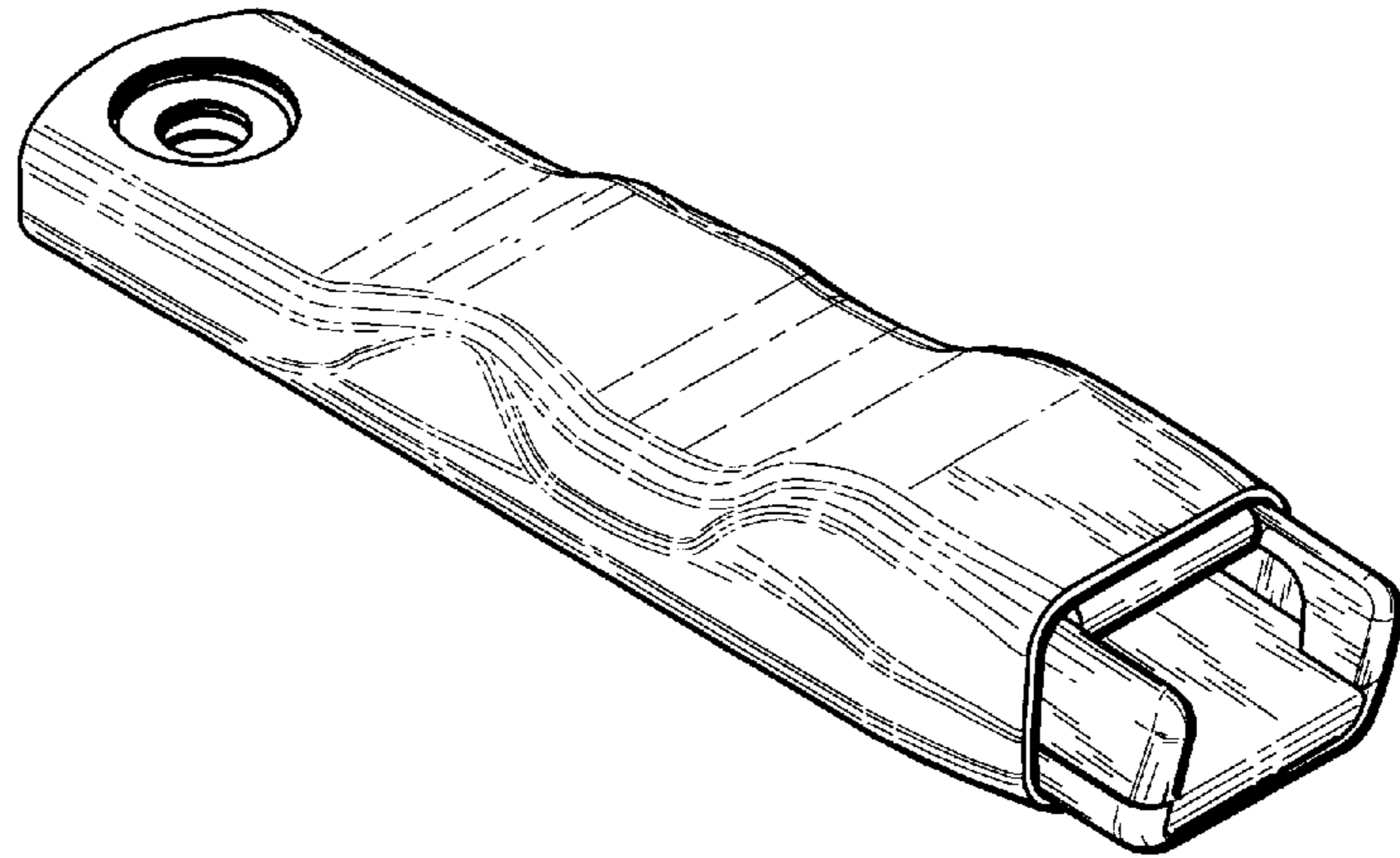
**Fig. 4**



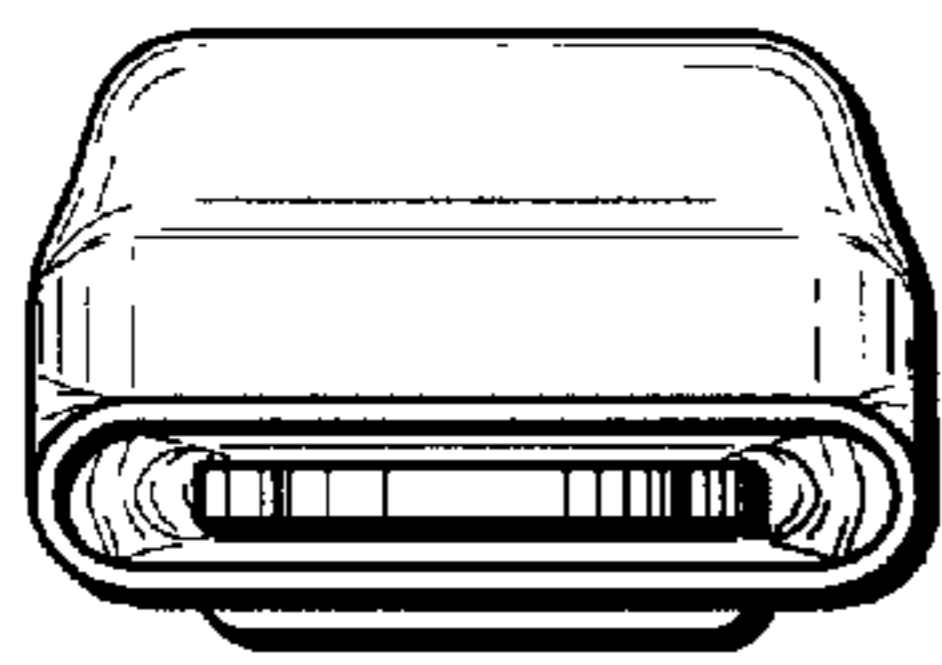
**Fig. 5**



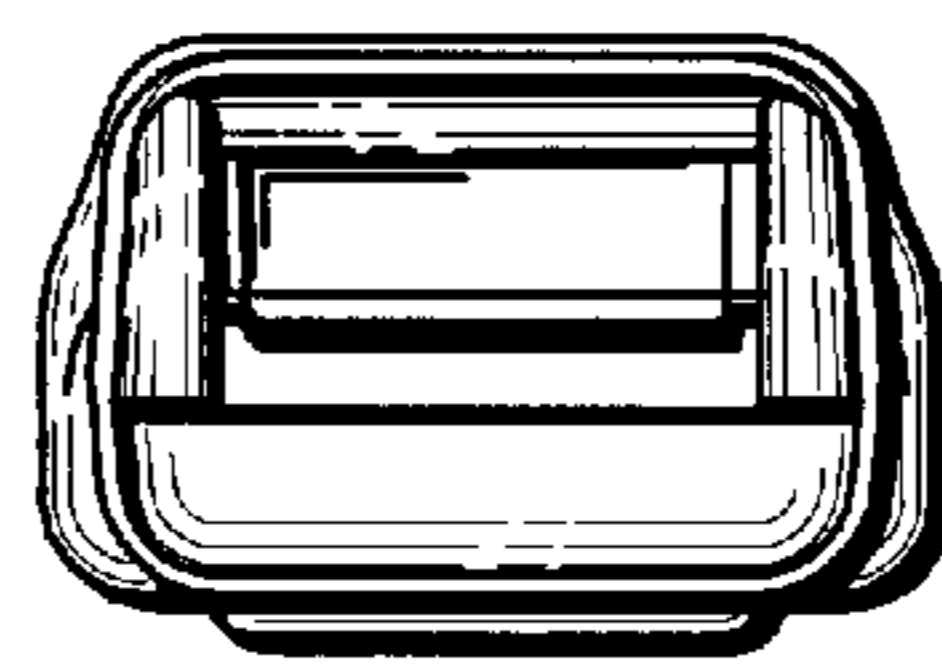
**Fig. 6**



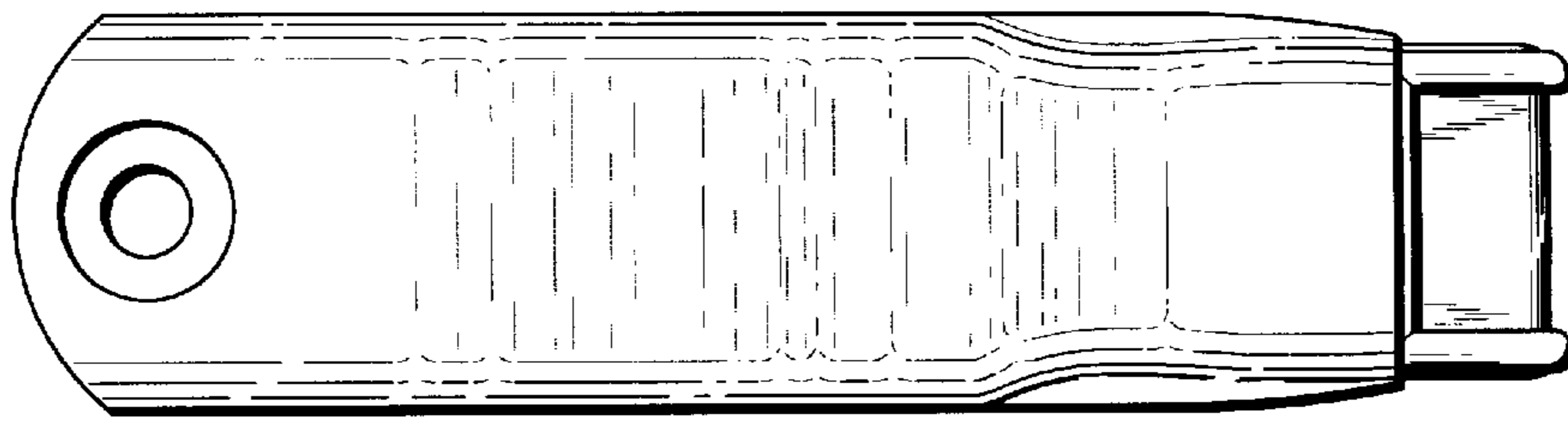
**Fig. 7**



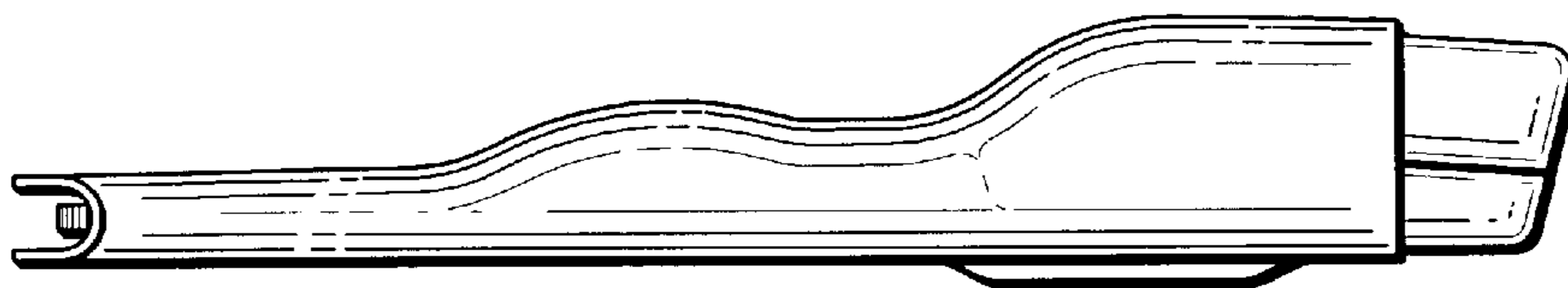
**Fig. 11**



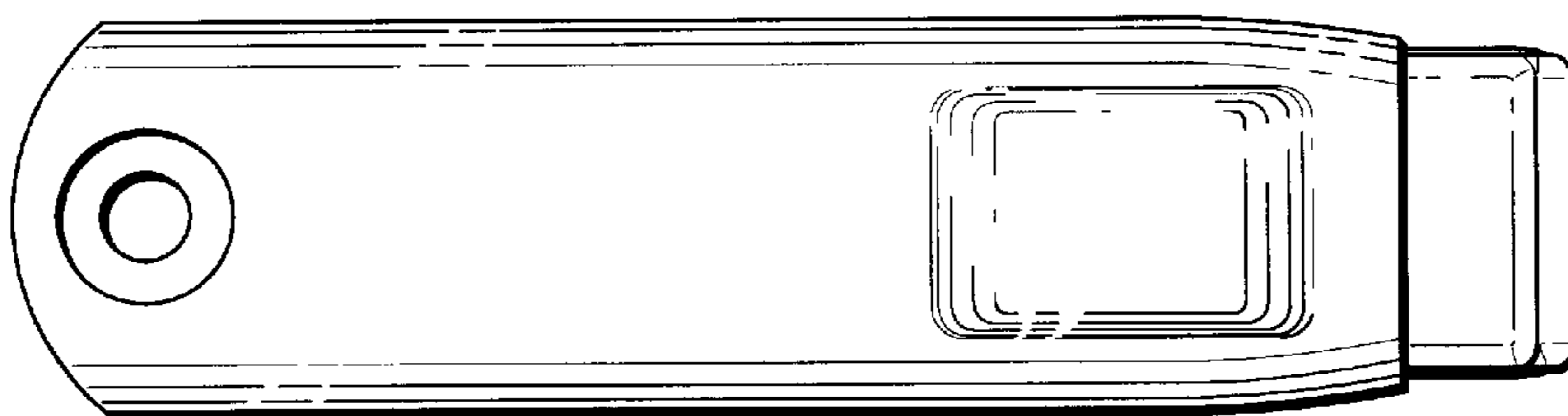
**Fig. 12**



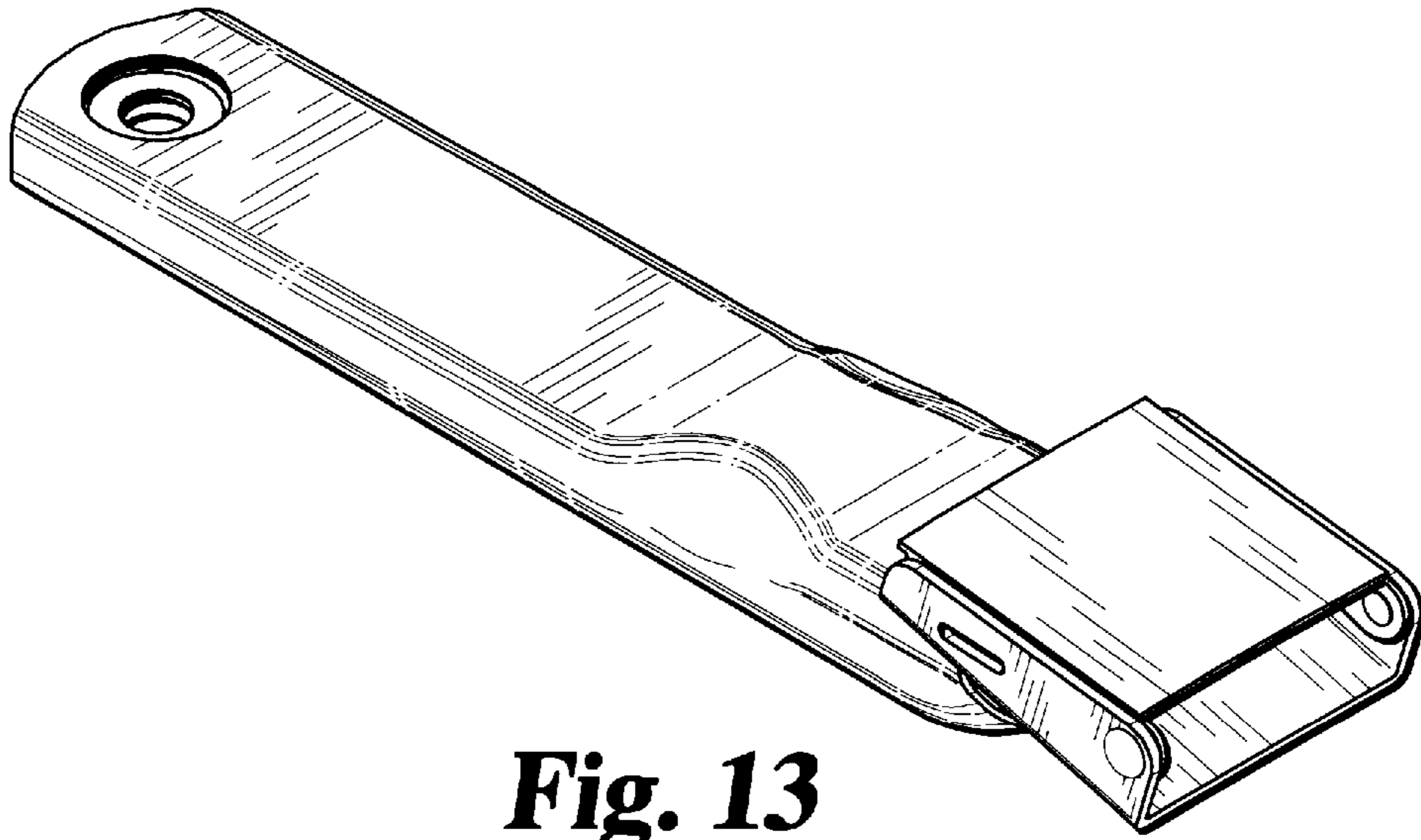
**Fig. 9**



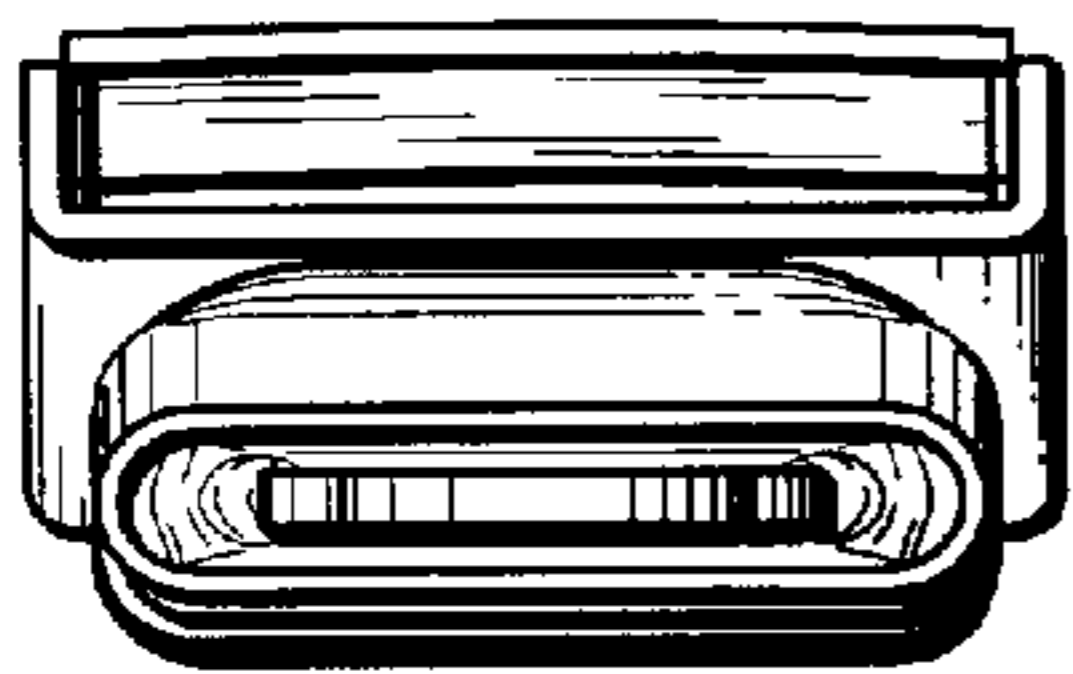
**Fig. 8**



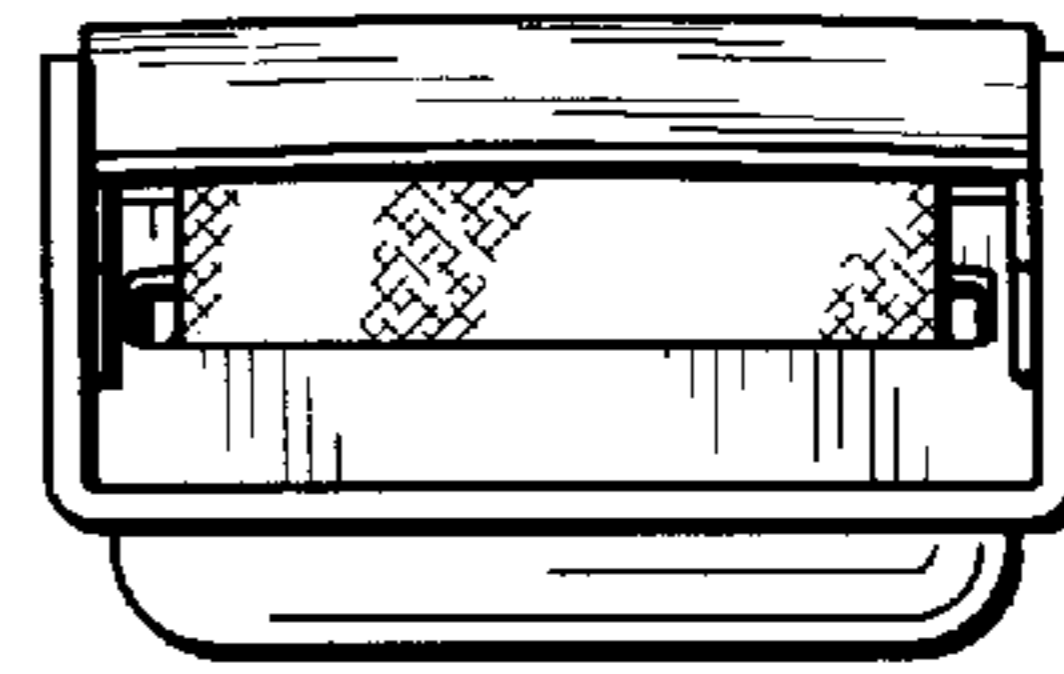
**Fig. 10**



**Fig. 13**

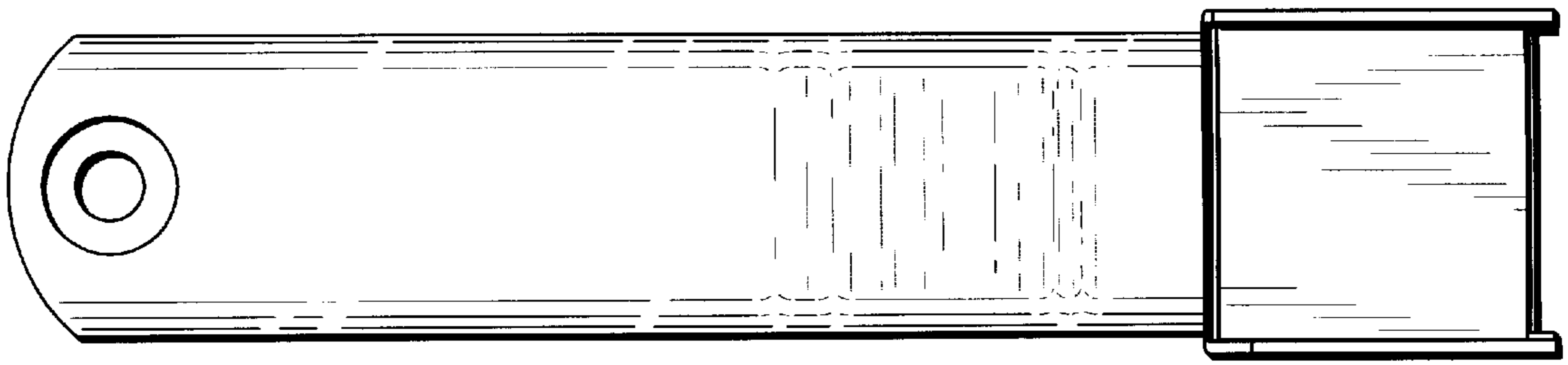


**Fig. 17**

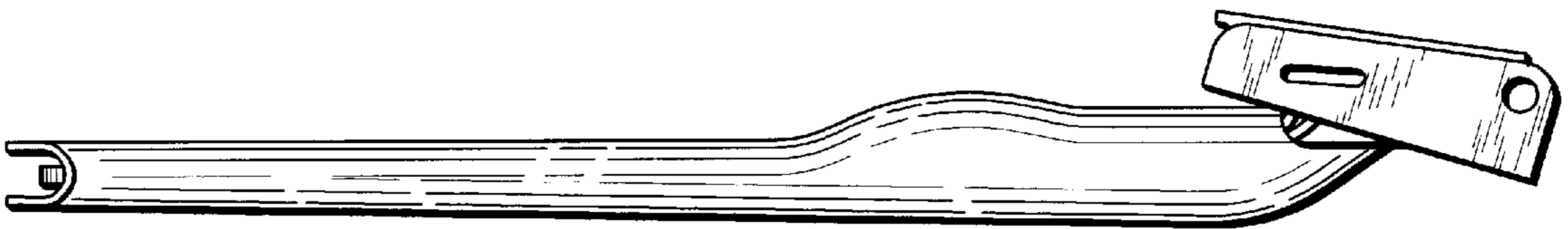


**Fig. 18**

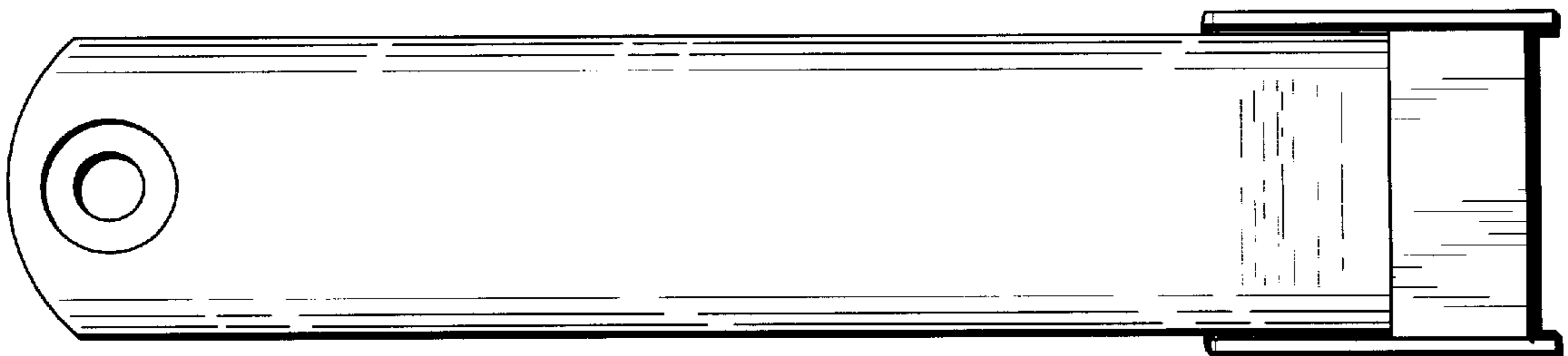




**Fig. 15**



**Fig. 14**



**Fig. 16**